

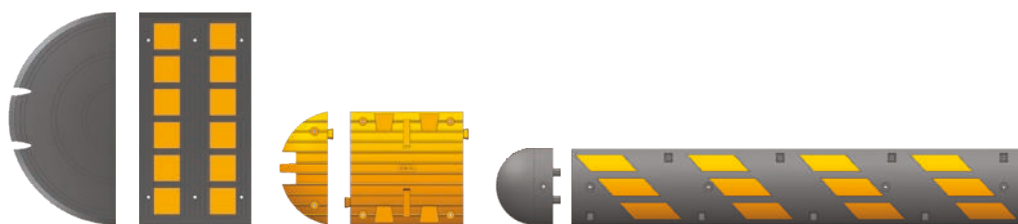

Voirie ◦ Road equipment

RALENTISSEURS ◦ SPEED BUMPS



RAMPE ◦ RAMPS

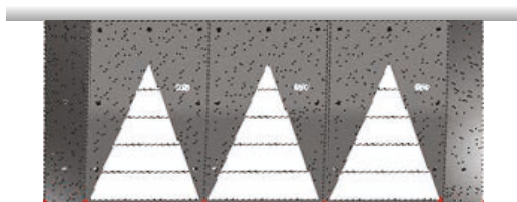
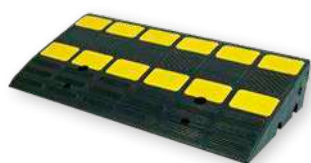

POTEAUX À MÉMOIRE DE FORME ◦ FLEXIBLE BOLLARDS

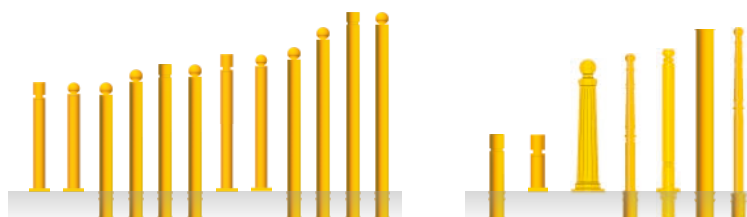
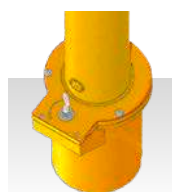

ÉQUIPEMENTS DE PARKING ◦ PARKING EQUIPMENT

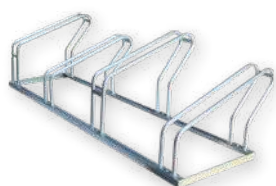

BARRIÈRES ◦ BARRIERS





DODANE

VOIE PUBLIQUE

DOS D'ÂNE

SPEED TABLE ◦ LOMO DE ASNO ◦ AUFPLASTERUNG



CAOUTCHOUC VULCANISÉ
VULCANIZED RUBBER
CAUCHO VULCANIZADO
VULKANISIERTEM KAUSCHUK

OPTION
OPTIONAL
OPCIÓN
OPTIONAL



Code	m		Surface m ² Surface Superficie Oberfläche
	L	P	
DODANE 4040	4,00	4,00	16
DODANE 4750	4,75	4,00	19
DODANE 5540	5,50	4,00	22
DODANE 6240	6,25	4,00	25
DODANE 7040	7,00	4,00	28
DODANE 7740	7,75	4,00	31
DODANE 8540	8,50	4,00	34
DODANE 9254	9,25	4,00	37

Option
Optional ◦ Opción ◦ Optional
LED jour / nuit
night / day ◦ día / noche ◦ tag / nacht

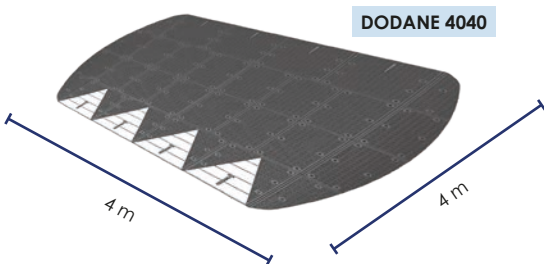
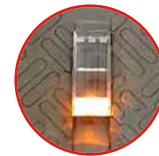

DODANE 4040

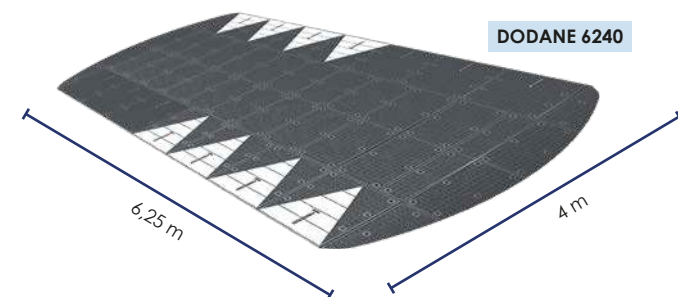

DODANE 6240

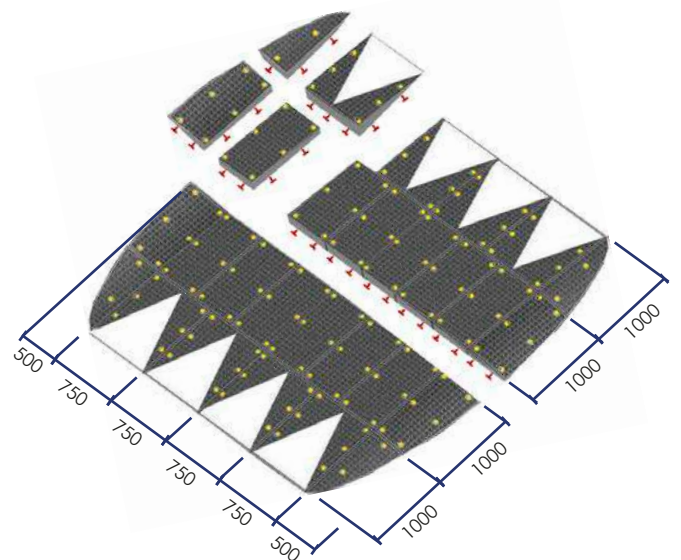

INCLUS ◦ INCLUDED ◦ INCLUIDO ◦ INKLUSIVE



200 m



Ø 12 x 130



OPTION ◦ OPTIONAL ◦ OPCIÓN ◦ OPTIONAL

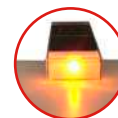

LED

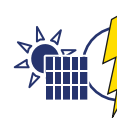
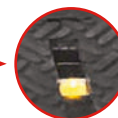

FLASH



VOIE PUBLIQUE

CO - KOB

COUSSIN BERLINOIS
 SPEED CUSHION ◦ COJÍN BERLINÉS ◦ BERLINER KISSEN

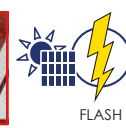
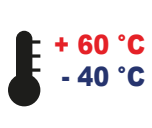

CO 3 R



CO 2 BR



CO 2 N



CO 3 NB



CO 3 BG



CO 3 BR



CO - KOB

VOIE PUBLIQUE

COUSSIN BERLINOIS
 SPEED CUSHION ◦ COJÍN BERLINÉS ◦ BERLINER KISSEN



CAOUTCHOUC VULCANISÉ
 VULCANIZED RUBBER
 CAUCHO VULCANIZADO
 VULKANISIERTEM KAUTSCHUK

OPTION
 OPTIONAL
 OPCIÓN
 OPTIONAL



2 M
 2,25 M

Code			mm			kg
KOB 6 N KOB 6 R		6	2250 x 1800 x 65	28	14	268
CO 2 N CO 2 R CO 2 BG CO 2 BR		4	2000 x 1800 x 65	24	8	240

• Sur commande ◦ Under request ◦ Bajo pedido ◦ Auf Bestellung

CO 2 NB CO 2 NJ		4	2000 x 1800 x 65	24	8	240
--------------------	--	---	------------------	----	---	-----

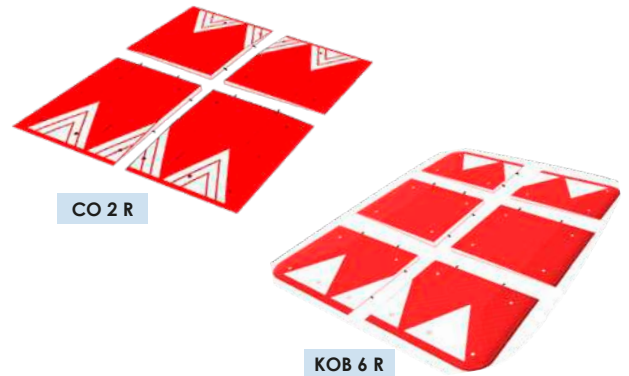

3 M

Code			mm			kg
KOB 8 N KOB 8 R		8	3000 x 1800 x 65	36	20	368
CO 3 N CO 3 R CO 3 BG CO 3 BR		6	3000 x 1800 x 65	34	14	360

• Sur commande ◦ Under request ◦ Bajo pedido ◦ Auf Bestellung

CO 3 NB CO 3 NJ		6	3000 x 1800 x 65	34	14	360
--------------------	--	---	------------------	----	----	-----



INCLUS ◦ INCLUDED ◦ INCLUIDO ◦ INKLUSIVE

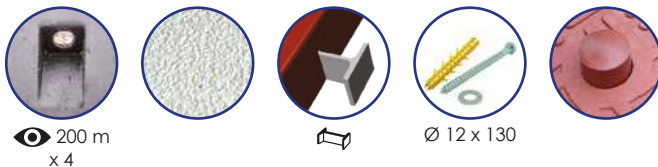

OPTION ◦ OPTIONAL ◦ OPCIÓN ◦ OPTIONAL

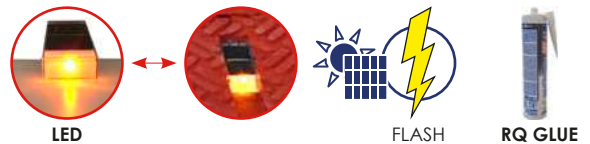

CO2 ▶ 3 x RQ GLUE
 CO3 / KOB6 ▶ 4 x RQ GLUE
 KOB8 ▶ 6 x RQ GLUE

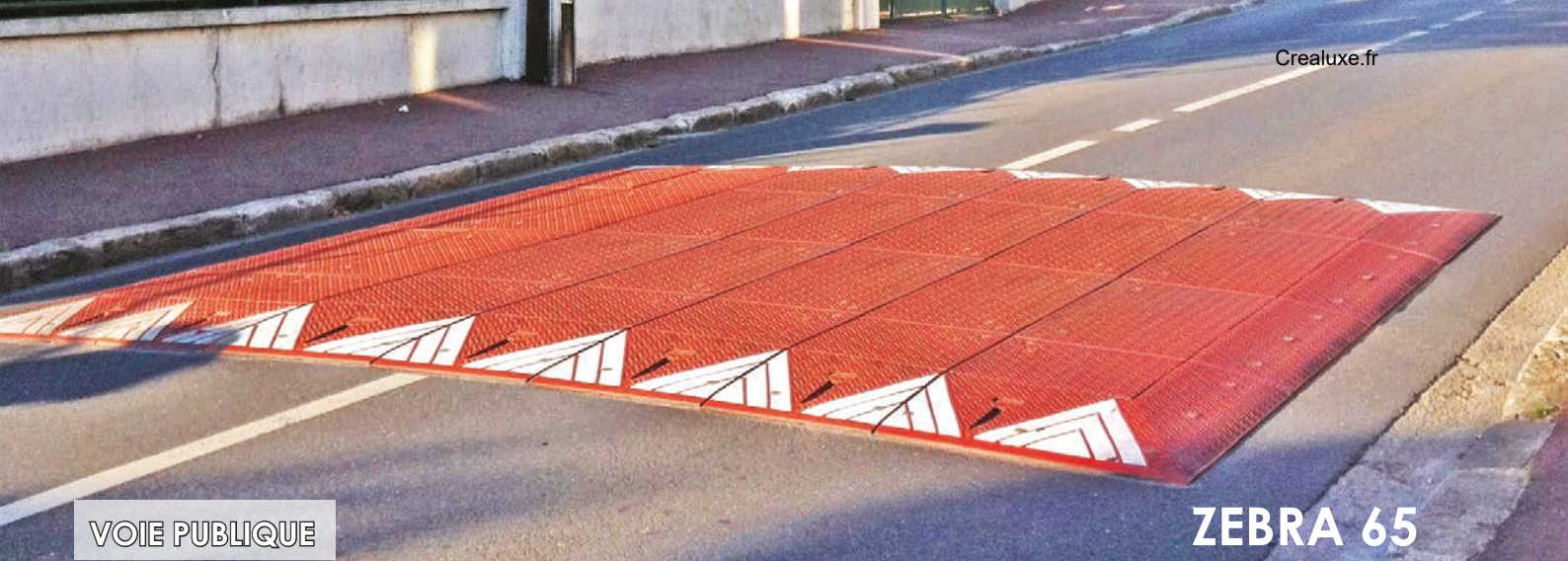

VOIE PUBLIQUE

ZEBRA 65

PLATEAU

SPEED TABLE ◦ REDUCTOR DE VELOCIDAD ◦ PLATEAU-KISSEN



CAOUTCHOUC VULCANISÉ
VULCANIZED RUBBER
CAUCHO VULCANIZADO
VULKANISIERTEM KAUSCHUK

OPTION
OPTIONAL
OPCIÓN
OPTIONAL

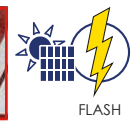

Code	
ZEBRA 65 BK	
ZEBRA 65 RO	

ZEBRA 65 BK / 5630

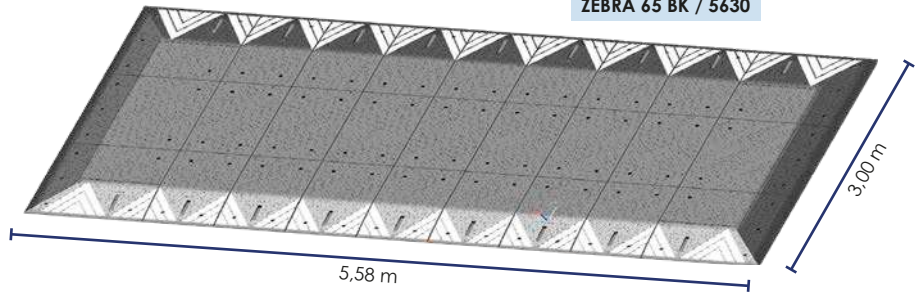

ZEBRA 65 RO / 3040

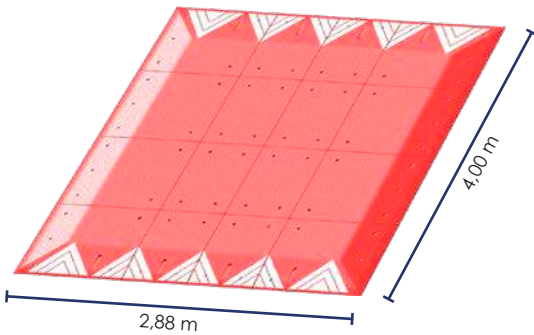

DIMENSIONS MODULABLES
MODULAR DIMENSIONS
DIMENSIONES MODULARES
VARIABLE ABMESSUNGEN

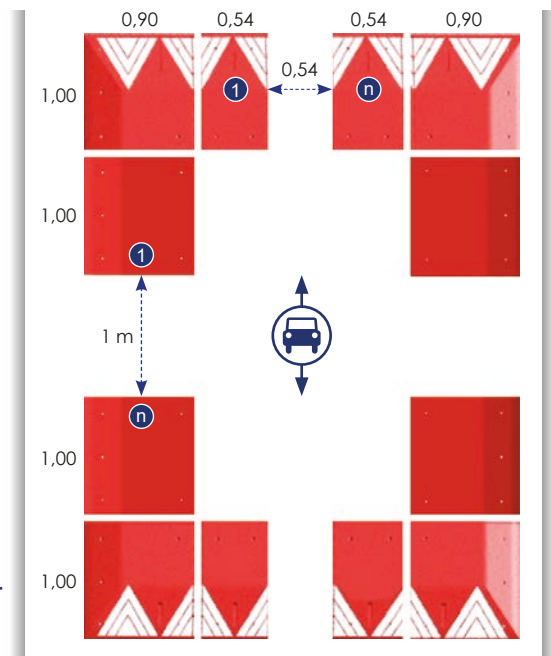

INCLUS ◦ INCLUDED ◦ INCLUIDO ◦ INKLUSIVE



OPTION ◦ OPTIONAL ◦ OPCIÓN ◦ OPTIONAL

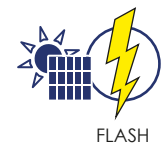
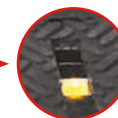



ZEBRA 100 BEL

ZEBRA 100

PLATEAU ◦ SPEED TABLE

RESALTO DE SECCIÓN TRANSVERSAL TRAPEZOIDAL ◦ PLATEAU-KISSEN

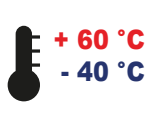

CAOUTCHOUC VULCANISÉ
VULCANIZED RUBBER
CAUCHO VULCANIZADO
VULKANISIERTEM KAUSCHUK

OPTION
OPTIONAL
OPCIÓN
OPTIONAL



Code	
ZEBRA 100 BK	●
ZEBRA 100 RO	●
ZEBRA 100 BKBEL	●
ZEBRA 100 ROBEL	●

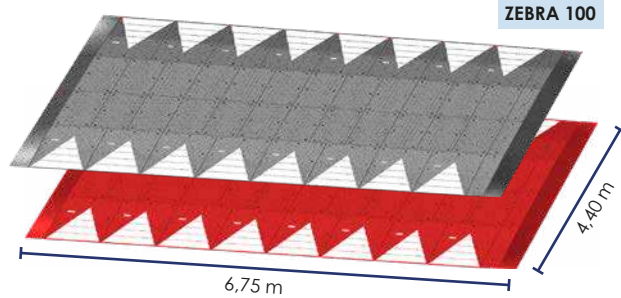

ZEBRA 100

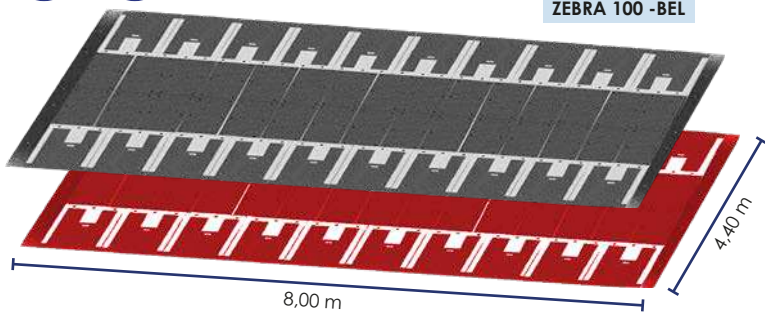
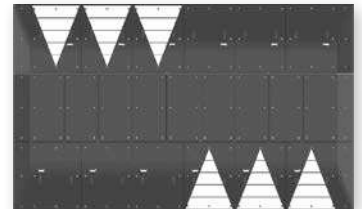

ZEBRA 100 -BEL

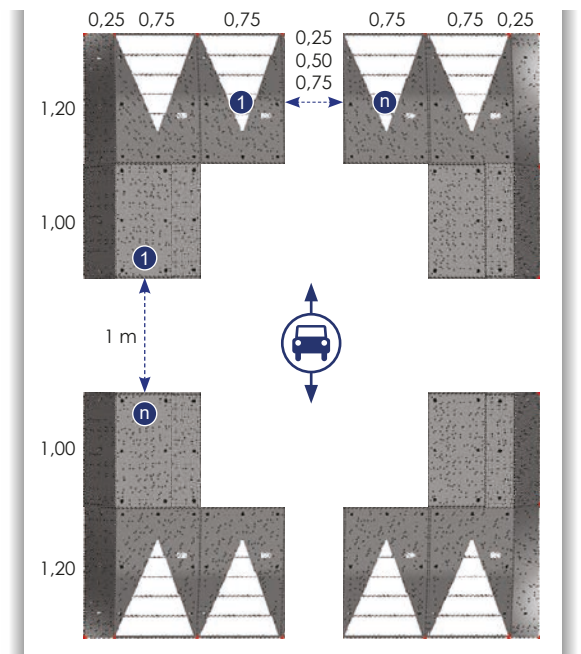

DIMENSIONS MODULABLES
MODULAR DIMENSIONS
DIMENSIONES MODULARES
VARIABLE ABMESSUNGEN

INCLUS ◦ INCLUDED ◦ INCLUIDO ◦ INKLUSIVE



OPTION ◦ OPTIONAL ◦ OPCIÓN ◦ OPTIONAL



LED

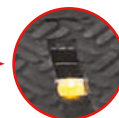

FLASH



PASSAGE PIÉTONS

ZEBRA CROSSING ◦ PASO PEATONAL SOBREELEVADO ◦ ZEBRA STREIFEN



CAOUTCHOUC VULCANISÉ
VULCANIZED RUBBER
CAUCHO VULCANIZADO
VULKANISIERTEM KAUSCHUK

OPTION
OPTIONAL
OPCIÓN
OPTIONAL

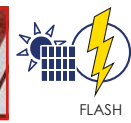

Code	
ZEBRA 100 PAPBK	
ZEBRA 100 PAPRO	
ZEBRA 100 BEMPAPBK	
ZEBRA 100 BEMPAPRO	

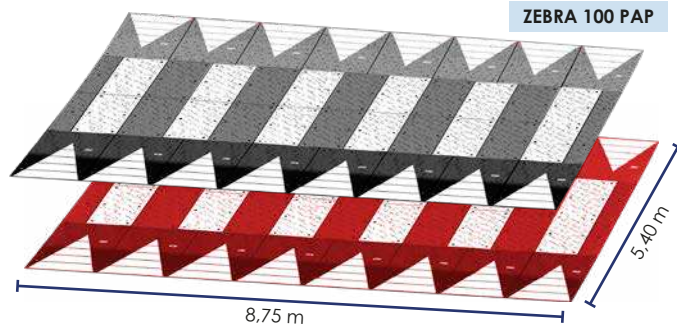

DIMENSIONS MODULABLES
MODULAR DIMENSIONS
DIMENSIONES MODULARES
VARIABLE ABMESSUNGEN

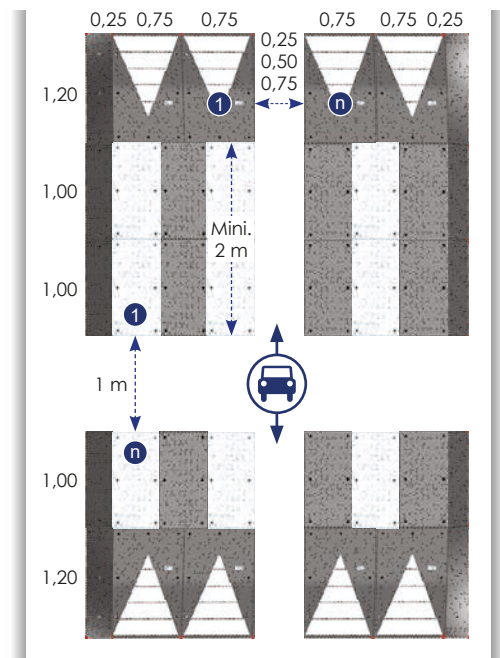
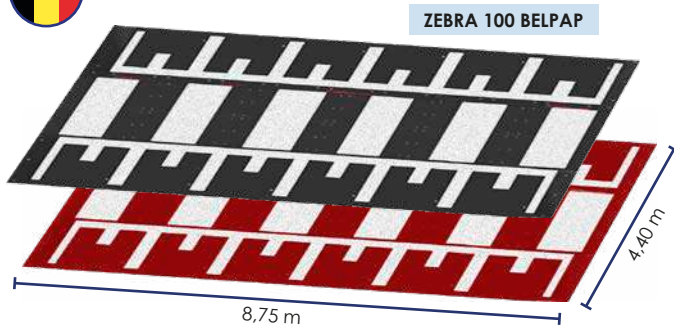

INCLUS ◦ INCLUDED ◦ INCLUIDO ◦ INKLUSIVE



OPTION ◦ OPTIONAL ◦ OPCIÓN ◦ OPTIONAL

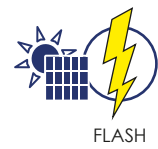
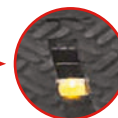



VOIE PUBLIQUE

RALENTISSEUR

SPEED RAMP ◦ REDUCTOR DE VELOCIDAD ◦ FAHRBAHNSCHWELLEN



CAOUTCHOUC VULCANISÉ
VULCANIZED RUBBER
CAUCHO VULCANIZADO
VULKANISIERTEM KAUTSCHUK

OPTION
OPTIONAL
OPCIÓN
OPTIONAL



Code	Largeur de route m Road width Ancho de carretera Breite	Surface m ² Surface Superficie Oberfläche	kg
ZE 300	3,00	7,20	509
ZE 325	3,25	7,80	567
ZE 350	3,50	8,40	576
ZE 375	3,75	9,00	634
ZE 400	4,00	9,60	692
ZE 425	4,25	10,20	701
ZE 450	4,50	10,80	759
ZE 475	4,75	11,40	817
ZE 500	5,00	12,00	826

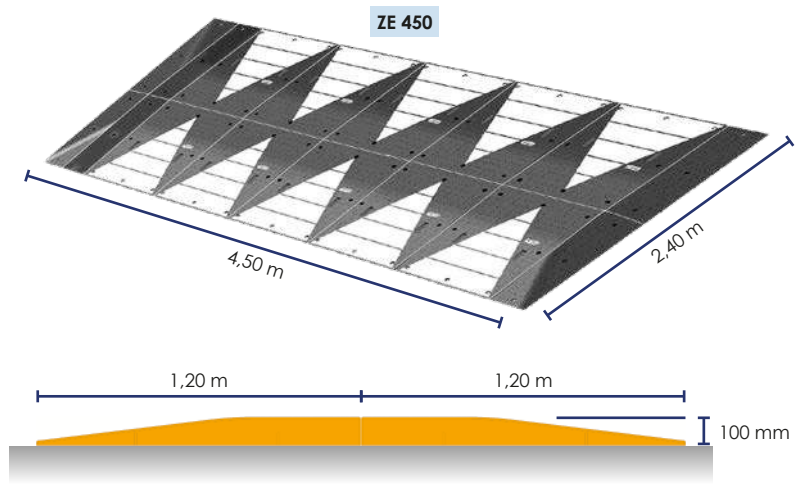

Couleur à préciser à la commande ◦ Color to be specified when ordering
Color a confirmar al realizar el pedido ◦ Farbe bei Bestellung anzugeben



INCLUS ◦ INCLUDED ◦ INCLUIDO ◦ INKLUSIVE



200 m



Ø 12 x 130



OPTION ◦ OPTIONAL ◦ OPCIÓN ◦ OPTIONAL

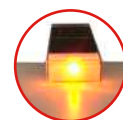

LED

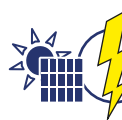

FLASH



RR

ZE

RAMPES

RAMPS ◦ RAMPAS ◦ BORDSTEIN-RAMPEN



+ 60 °C
- 40 °C



CAOUTCHOUC VULCANISÉ
VULCANIZED RUBBER
CAUCHO VULCANIZADO
VULKANISIERTEM KAUSCHUK



RR

Code	H	I	kg	Icon
RR 35	35	300	6,50	4
RR 100	100	300	12,00	4
RR 150	150	360	19,00	4
RR 200	200	450	32,00	4
RRD 35	35	300	2,00	2
RRD 100	100	300	4,00	2
RRD 150	150	360	8,00	2
RRD 200	200	450	17,00	2

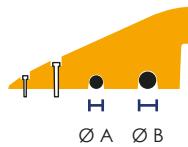

Code	Ø A	Ø B
RR / RRD 35	-	10
RR / RRD 100	25	30
RR / RRD 150	30	35
RR / RRD 200	35	40

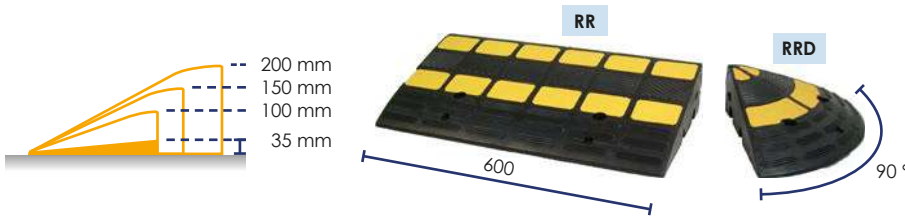
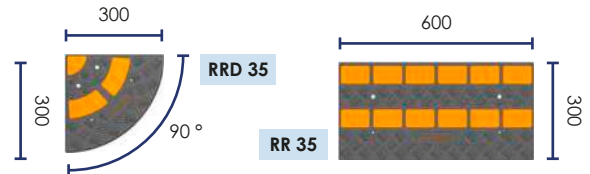

OPTION ◦ OPTIONAL ◦ OPCIÓN ◦ OPTIONAL



RR FIX 4 SB
2 x Ø 6
2 x Ø 10



RR SPIKE 4 SB
2 x (Ø 6 x 300)
2 x (Ø 10 x 300)



RQ GLUE

ZE

Code	Icon 1	Icon 2	kg
ZE 100 RAMP	6	7	55
ZE 100 END	3	5	23
ZE 25 G	3	3	17
ZE 25 D	3	3	17

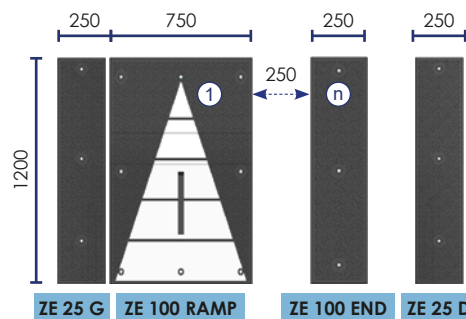

INCLUS ◦ INCLUDED ◦ INCLUIDO ◦ INKLUSIVE



FIX 1 SB
Ø 12 x 130

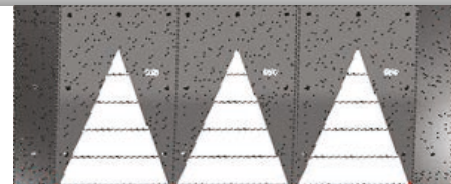

ZE 25 G ZE 100 RAMP

ZE 25 D



SEP



+ 60 °C
- 40 °C

CAOUTCHOUC VULCANISÉ
VULCANIZED RUBBER
CAUCHO VULCANIZADO
VULKANISIERTEM KAUSCHUK

0 100 mm

ROND-POINT
ROUND ABOUT ◦ ROTONDA ◦ KREISVERKEHR

Code			
ILO 300	40	24	513

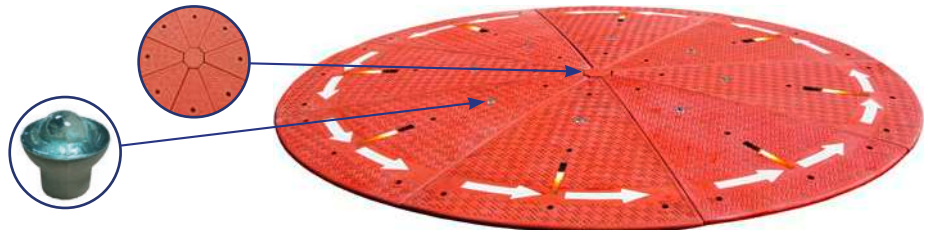

3000

0 / 100 mm

INCLUS ◦ INCLUDED ◦ INCLUIDO ◦ INKLUSIVE



x 8



Ø 12 x 130

EN 1463-2

OPTION ◦ OPTIONAL ◦ OPCIÓN ◦ OPTIONAL



LED

x 8

FLASH

RQ GLUE

ILO 300 ▶ 4 x RQ GLUE

SÉPARATEUR DE VOIE FRANCHISSABLE
TRAFFIC DIVIDER ◦ SEPARADOR DE VÍAS ◦ TRENNBALKEN

Code			
SEP 70 NB	●	2	3,80
SEP 70 RB	●	2	3,80
SEP 120 NB	●	3	8,50
SEP 120 RB	●	3	8,50



SEP 70

700



45 mm

150

SEP 120 NB



SEP 120

1200



SEP 70 RB

INCLUS ◦ INCLUDED
INCLUIDO ◦ INKLUSIVE



OPTION ◦ OPTIONAL ◦ OPCIÓN ◦ OPTIONAL



REF 501 SBS
EN 1463-2

SPIKES
Ø 12 x 300

FIXSAFE
Ø 12 x 120

RQ GLUE





ILO 4025

ILO

PLOT RALENTISSEUR
CIRCULAR SPEED BUMP
REDUCTOR DE VELOCIDAD CIRCULAR
RUNDE BODENSCHWELLEN



CAOUTCHOUC VULCANISÉ
 VULCANIZED RUBBER
 CAUCHO VULCANIZADO
 VULKANISIERTEM KAUSCHUK

Code		
ILO 4025		1
ILO 4025 VE		



ILO 4025 VE



ILO 4025

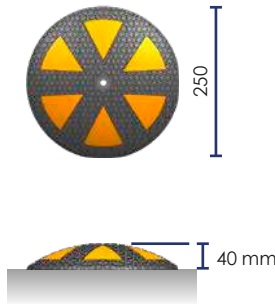

Code		
ILO 5035	x 2	8
ILO 6050	x 2	8
ILO 7040	x 2	8

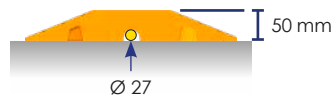

ILO 5035

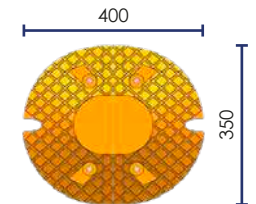
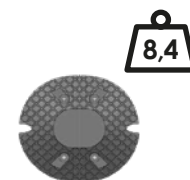

Combinaisons possibles ◦ Possible combinations
 Combinaciones posibles ◦ Mögliche Kombinationen



ou
 or
 ◦
 oder

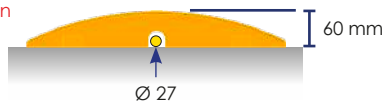

ILO 6050

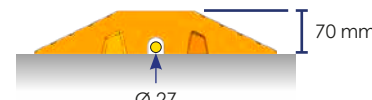
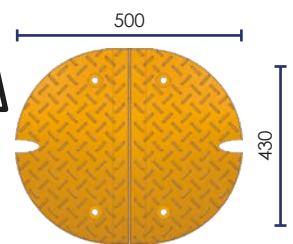
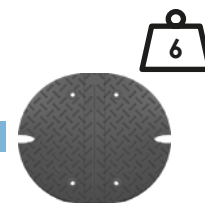

ILO 7040

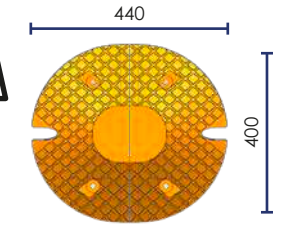
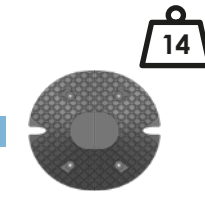

OPTION ◦ OPTIONAL
 OPCIÓN ◦ OPTACIONAL



SPIKES
 Ø 12 x 300



FSAFE 4 SB
 Ø 12 x 120



RQ GLUE

INCLUS ◦ INCLUDED
 INCLUIDO ◦ INKLUSIVE



ILO 6050





TAH

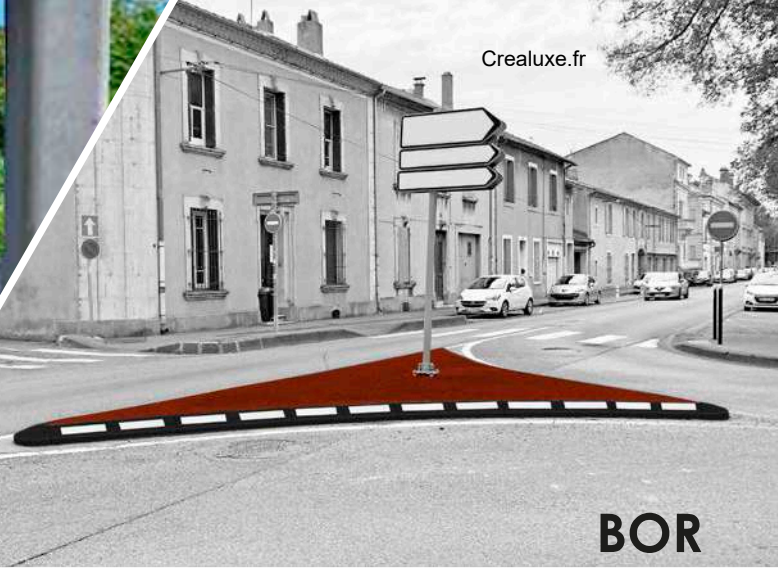

BOR

TAPIS ANTI HERBE ◦ GRASS PROTECTION PLATE
PLACA ANTIHERBAS ◦ ANTI-UNKRAUT PLATTEN



CAOUTCHOUC
 RUBBER
 CAUCHO
 KAUSCHUK
 ▶ TAH 1800

Code	Trou poteaux mm Post hole ◦ Agujero poste Pfostenloch	kg
TAH 500	80 x 80 ou ø 70 et ø 60	3,55
TAH 750	80 x 80 ou ø 70 et ø 60	7,60
TAH 1800	Ajustable 170 x 130	15,5

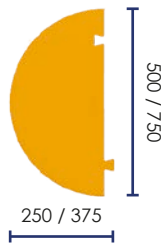

TAH 500 / 750

INCLUS ◦ INCLUDED
 INCLUIDO ◦ INKLUSIVE

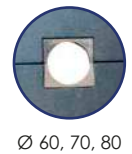

OPTION ◦ OPTIONAL
 OPCIÓN ◦ OPTIONAL



SPIKES
 Ø 12 x 300
 TAH 1800

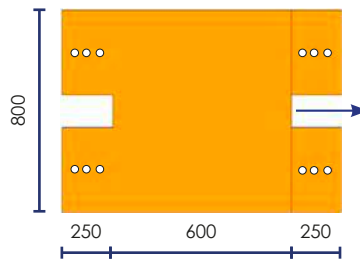

TAH 1800

BORDURE DE DÉLIMITATION D'ÎLOT
RUBBER BORDER ◦ BORDE DE GOMA ◦ BEGRENZUGSBALKEN



Code	kg
BOR 1000 BK	6,65
BOR 250 BK	0,50

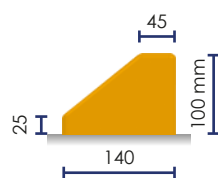

BOR 250 BK

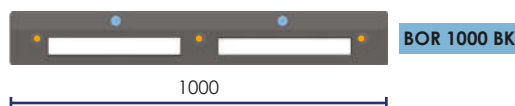

BOR 1000 BK



BOR 1000 BK

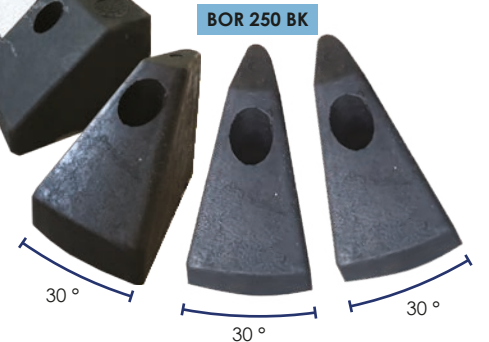

BOR 250 BK

INCLUS ◦ INCLUDED ◦ INCLUIDO ◦ INKLUSIVE



EN 1463-2 ▶ BOR1000BK
 x 2
 ▶ BOR1000BK

OPTION ◦ OPTIONAL ◦ OPCIÓN ◦ OPTIONAL







SPIKES
 Ø 12 x 300
 FIXSAFE
 Ø 12 x 120





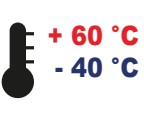

RALENTISSEUR ◦ **SPEED BUMP** ◦ **REDUCTOR DE VELOCIDAD** ◦ **FAHRBAHNSCHWELLE**

SPEED 70 SPEED 50
FAST 60

SPEED

Code	H mm		
SPEED 50	50	4	9,4
SPEND 50	50	4	4,9
SPEED 70	70	4	13,8
SPEND 70	70	4	8,0

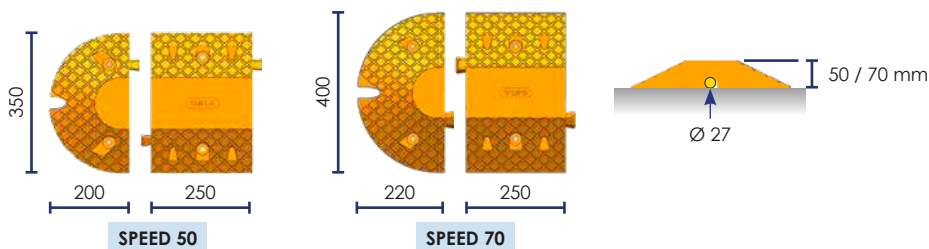

INCLUS ◦ **INCLUDED** ◦ **INCLUIDO** ◦ **INKLUSIVE**





x 2 Ø 27



OPTION ◦ **OPTIONAL** ◦ **OPCIÓN** ◦ **OPTIONAL**







SPIKES Ø 12 x 300
FSAFE 4 SB Ø 12 x 120
RQ GLUE

FAST 60

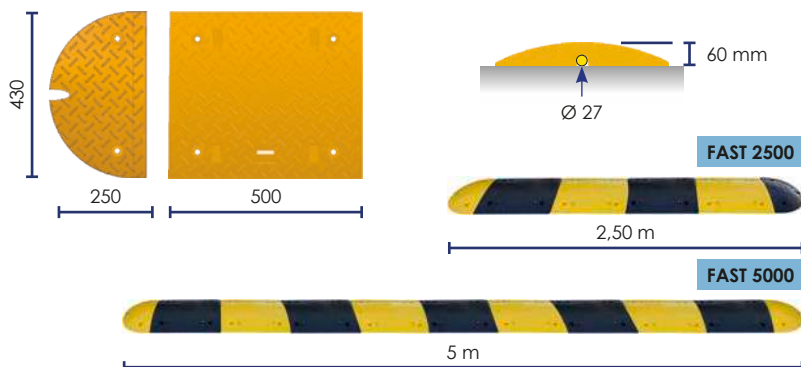
Code	H mm		
FAST 60 NJ	60	8	18,0
FASTEND 60	60	4	6,7



• Complet avec fixations ◦ Set with fixations
Completo con fijaciones ◦ Komplettsset inkl. Befestigungen

Code	H mm	L	
FAST 2500	60	2,50 m	45,0
FAST 5000	60	5 m	83,0





INCLUS ◦ **INCLUDED** ◦ **INCLUIDO** ◦ **INKLUSIVE**





2 x 2 Ø 27

OPTION ◦ **OPTIONAL** ◦ **OPCIÓN** ◦ **OPTIONAL**

SPIKES Ø 12 x 300
FSAFE 4 SB Ø 12 x 120
RQ GLUE



RALENTISSEUR ◦ **SPEED BUMP** ◦ **REDUCTOR DE VELOCIDAD** ◦ **FAHRBAHNSCHWELLE**



FAST 70



FAST 50

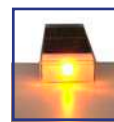

FASTLED

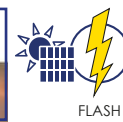

FLASH

Code	H mm		
FAST 50 NJ	50	8	14,0
FASTLED 50 NJ	50	8	14,0
FASTEND 50 NJ	50	4	6,4
FAST 70 NJ	70	8	23,0
FASTLED 70 NJ	70	8	23,0
FASTEND 70 NJ	70	4	8,0

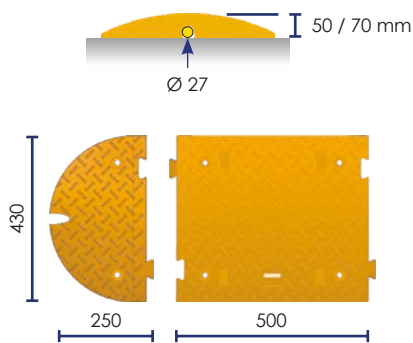

FAST 50 / 70 NJ



FASTEND 50 / 70 NJ

• Complet avec fixations ◦ Set with fixations
Completo con fijaciones ◦ Komplettsset inkl. Befestigungen

Code	H mm	L	
FAST 5025	50	2,50 m	36
FAST 5050	50	5 m	73
FAST 7025	70	2,50 m	56
FAST 7050	70	5 m	111



FAST 5025



FAST 7050

• Complet avec LED et fixations ◦ Set LED with fixations
Completo LED con fijaciones ◦ Komplettsset inkl. LED und Befestigungen

Code	H mm	L	
FASTLED 5025	50	2,50 m	36
FASTLED 5050	50	5 m	73
FASTLED 7025	70	2,50 m	56
FASTLED 7050	70	5 m	111



FLASH



FASTLED 5025



FASTLED 7050

INCLUS ◦ INCLUDED ◦ INCLUIDO ◦ INKLUSIVE



2 x 2



Ø 27



OPTION ◦ OPTIONAL ◦ OPCIÓN ◦ OPTIONAL



SPIKES
Ø 12 x 300



FSAFE 4 SB
Ø 12 x 120



RQ GLUE



FASTLED

EASYFAST

EASYSPEED

RALENTISSEUR

SPEED RAMP ◦ REDUCTOR DE VELOCIDAD ◦ FAHRBAHNSCHWELLE

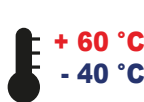

EASYFAST 75
EASY SPEED 75

EASYFAST 55
EASY SPEED 55

EASYFAST

Code	H mm		kg
EASYFAST 55		2	6,2
EASYFAST 55 NB	55	2	6,2
ENDFAST 55		1	1,2
EASYFAST 75		2	8,5
EASYFAST 75 NB	75	2	8,5
ENDFAST 75		1	2,9

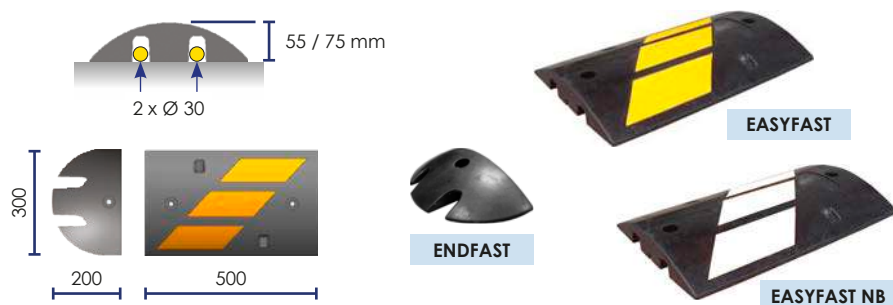

EASYSPEED

Code	H mm		kg
EASYSPEED 55 NJ		4	28
END 55 N	55	1	3
EASYSPEED 55 CAP		6	34
EASYSPEED 75 NJ		4	45
END 75 N	75	1	5
EASYSPEED 75 CAP		6	55

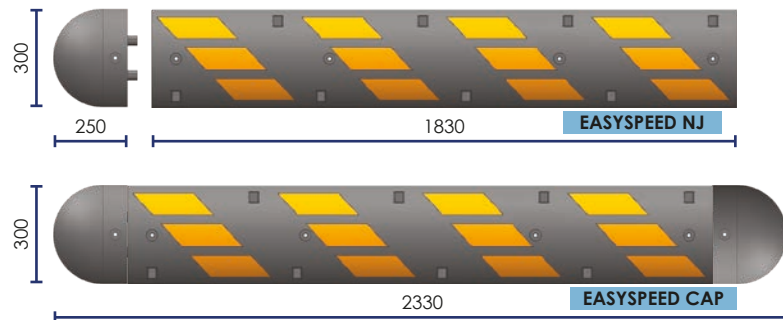

INCLUS ◦ INCLUDED ◦ INCLUIDO ◦ INKLUSIVE



SPIKE
EASYSPEED

OPTION ◦ OPTIONAL ◦ OPCIÓN ◦ OPTIONAL



EASYFAST 4 H SB
EASYFAST

SPEED H 4 SB
EASYSPEED

SPIKES
Ø 12 x 300

FSAFE 4 SB
Ø 12 x 120

RQ GLUE



HD 700

RALENTISSEUR POIDS LOURD ◦ **HEAVY DUTY SPEED BUMP**
REDUCTOR DE VELOCIDAD PARA CAMIONES ◦ **LKW-FAHRBAHNSCHWELLE**

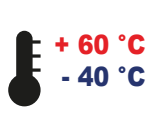

Code	H mm		
HD 700 NJ	70	8	30,0
HDEND 700 NJ		4	7,5

• Eléments séparés ◦ Single element
 Elementos separados ◦ Separate Elemente

HD 700 JA	70	4	14,8
HD 700 BK		4	14,8
HDEND 700 JA		2	3,7
HDEND 700 BK		2	3,7

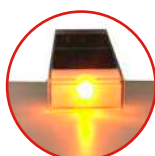
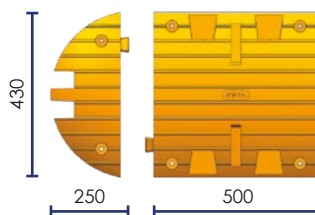
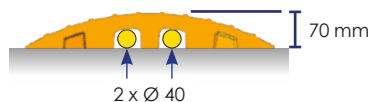

Option LED x 2



• Complet avec fixations ◦ Set with fixations
 Completo con fijaciones ◦ Komplettsset inkl. Befestigungen

Code	H mm	L	
HD 7025	70	2,50 m	70
HD 7050		5 m	144



HD 7025

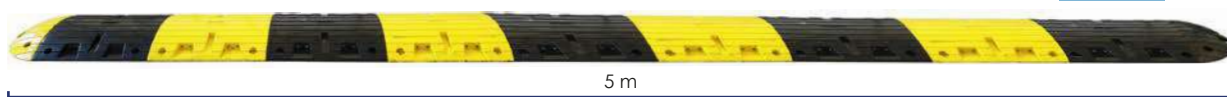

HD 7050

INCLUS ◦ **INCLUDED** ◦ **INCLUIDO** ◦ **INKLUSIVE**



x 8

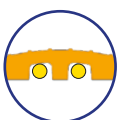

2 x Ø 40



OPTION ◦ **OPTIONAL** ◦ **OPCIÓN** ◦ **OPTIONAL**

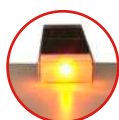

LED



FLASH

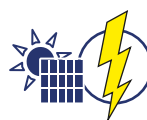

SPIKE 4 SB
 Ø 12 x 300



FSAFE 4 SB
 Ø 12 x 120



RQ GLUE



SLOBUMP



EASYROLL

RALENTISSEUR

SPEED RAMP ◦ REDUCTOR DE VELOCIDAD ◦ FAHRBAHNSCHWELLE

SLOBUMP



Code		
SLOBUMP	4	29,50
SLOEND	1	2,27



INCLUS ◦ INCLUDED ◦ INCLUIDO ◦ INKLUSIVE

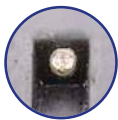

x 6



SPIKE 4 SB
Ø 12 x 300

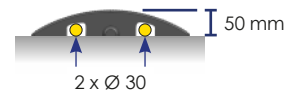

OPTIONAL
OPCIÓN
OPTIONAL



FSAFE 4 SB
Ø 12 x 120

EASYROLL - RALENTISSEUR TRANSPORTABLE

PORTABLE FOLDING SPEED BUMP ◦ REDUCTOR DE VELOCIDAD PLEGABLE
TRANSPORTIERBARER FAHRBAHNSCHWELLE

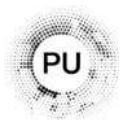

USAGE TEMPORAIRE ◦ TEMPORARY USE ◦ USO TEMPORARIO ◦ VORÜBERGEHENDE NUTZUNG

Code		
EASYROLL	360 x 250 x 355	12

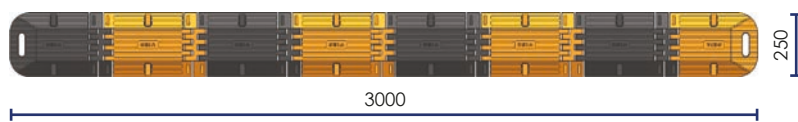

INCLUS ◦ INCLUDED ◦ INCLUIDO ◦ INKLUSIVE

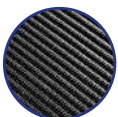

Antidérapant
Non Skid : underneath
Antideslizante
Rutschfest





SAFETY 25

COUSSIN DE RALENTISSEMENT

SPEED BUMP ◦ REDUCTOR DE VELOCIDAD ◦ FAHRBAHNSCHWELLE

SAFETY 25

SAFETY 100

SAFETY 70

SAFETY 30
SAFETY 50

OIL

Code	H mm			kg
SAFETY 25	20	6	-	7
SAFETY 30	30	6	2 x 15	10
SAFETY 50	50	6	2 x 25	19
SAFETY 70	70	6	2 x 35	27
SAFETY 100	100	4	2 x 50	27
SCUP 25	20	3	-	3,6
SCUP 30	30	3	2 x 15	4
SCUP 50	50	4	2 x 25	8
SCUP 70	70	4	2 x 35	18
SCUP 100	100	4	2 x 50	25

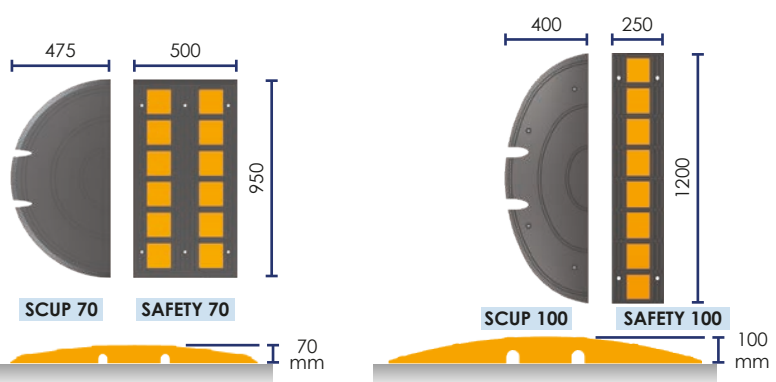
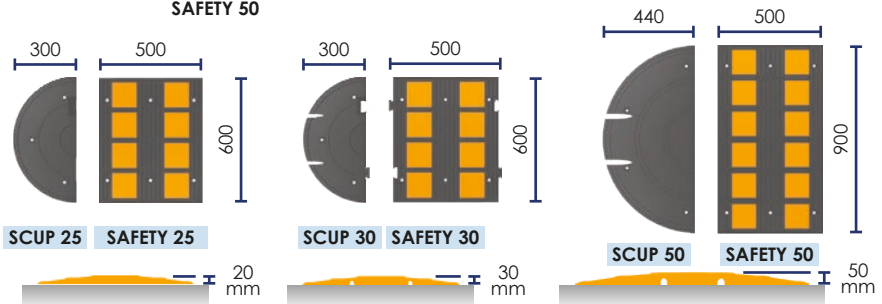

• Complet avec fixations ◦ Set with fixations
Completo con fijaciones ◦ Kompletset inkl. Befestigungen

Code	L mm	I mm	H mm		kg
SAFETY 2525	2600	600	20	-	45
SAFETY 3025	2600	600	30	2 x 15	58
SAFETY 5025	2880	900	50	2 x 25	106
SAFETY 7025	2950	950	70	2 x 35	158
SAFETY 10025	2550	1200	100	2 x 50	715
SAFETY 2550	5100	600	20	-	82
SAFETY 3050	5100	600	30	2 x 15	118
SAFETY 5050	4880	900	50	2 x 25	192
SAFETY 7050	4950	950	70	2 x 35	177
SAFETY 10050	4800	1200	100	2 x 50	1450



INCLUS ◦ INCLUDED ◦ INCLUIDO ◦ INKLUSIVE

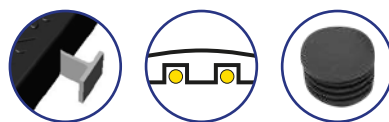

SAFETY 30 / 50 / 70 / 100

OPTION ◦ OPTIONAL ◦ OPCIÓN ◦ OPTIONAL





HERSE

EASYTEEL

RALENTISSEUR ACIER ○ **STEEL SPEED BUMP**
REDUCTOR DE VELOCIDAD EN ACERO
FAHRBAHNSCHWELLE AUS STAHL



EASYTEEL

Code		
EASYTEEL 100 J	6	18,0
EASYTEEL 25 J	4	5,0
EASYTEEL END J	2 x 4	2 x 6,0

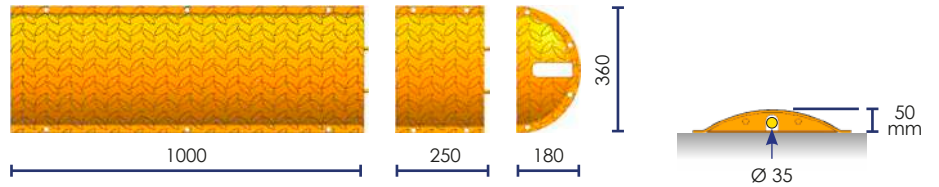

INCLUS
INCLUDED
INCLUIDO
INKLUSIVE



Ø 35 mm

OPTION
OPTIONAL
OPCIÓN
OPTIONAL



FSAFE 4 SB
 Ø 12 x 120



EASYTEEL 100 J



EASYTEEL 25 J



EASYTEEL END J

HERSE

Code		
HERSE 1000	6	28,5
HERSE END	2	2 x 4,0

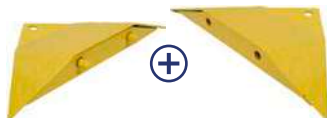
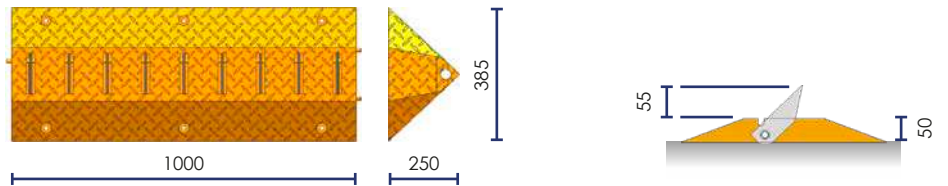

HERSE END



HERSE 1000



INCLUS
INCLUDED
INCLUIDO
INKLUSIVE



FIXSAFE
 Ø 12 x 120





REF



POV

RÉFLECTEUR LUMINEUX ET CLOU DE VOIRIE o GLASS AND SOLAR ROAD STUD

BALIZAS REFLECTANTES / CAPTAFAROS o BODENREFLEKTOREN UND MARKIERUNGSNAGEL

REF

Code	∅ mm	kg
REF 501 SBS	50	0,20
REF 501 BASE		0,05
REF 100 SBS	100	0,56



EN 1463-2



Code	mm	kg
REF 140 LED	∅ 140 x H 50	0,74



REF 140 LED

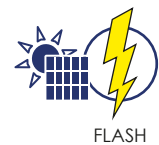

FLASH



PSR

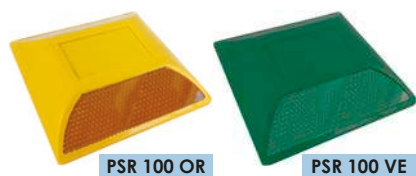

PSR 100 OR

PSR 100 VE

Code	Light	Color	kg
PSR 100 OR		Red	0,12
PSR 100 VE		Green	

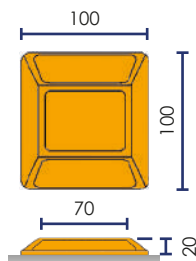

Option
Optional
Opción
Optional



RQ GLUE



PSR 103 BU

PSR 103 OR

PSR 103 WH

PSR 103 VE

Code	Light	Color	kg
PSR 103 BU	3	Blue	0,30
PSR 103 BUFIX *	3	Blue	0,30
PSR 103 OR	3	Orange	0,30
PSR 103 ORFIX *	3	Orange	0,30
PSR 103 WH	3	White	0,30
PSR 103 WHFIX *	3	White	0,30
PSR 103 VE	3	Green	0,30
PSR 103 VEFIX *	3	Green	0,30



FLASH

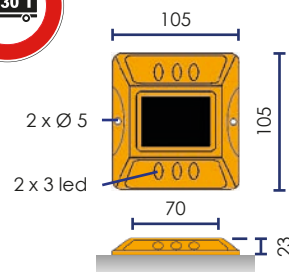

FLASH

POV

Code	∅ mm	kg
POV 100	100	0,21
POV 150	150	0,25

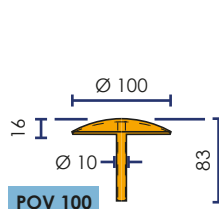

POV 100

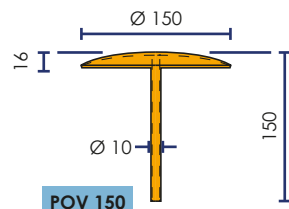

POV 150

OPTION o OPTIONAL o OPCIÓN o OPTIIONAL

► p. 281

PODSEAL







TPA 660 / 810

BALISE FLEXIBLE ◦ **FLEXIBLE BOLLARD**
BALIZA FLEXIBLE ◦ **FLEXIBLE PFOSTEN**



Autres couleurs : mini 300
 Otros colors : mini 300
 Andere Farben : Mini 300

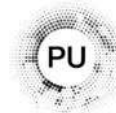

+ 50 °C
 - 20 °C

Code	
TPA 660 BK	
TPA 810 BK	
TPA 660 OR	RAL 2017
TPA 810 OR	RAL 2017
TPA 660 VE	RAL 6024
TPA 810 VE	RAL 6024



Ø 80 mm

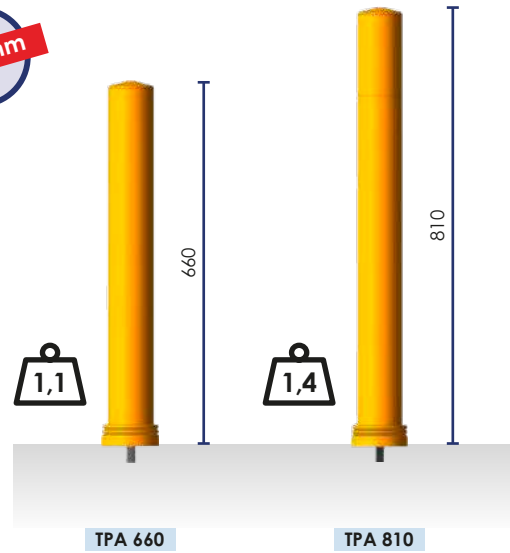

INCLUS
 INCLUDED ◦ INCLUIDO ◦ INKLUSIVE



Ø 10

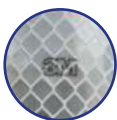



POTELET FLEXIBLE À MÉMOIRE DE FORME

FLEXIBLE BOLLARD WITH SHAPE MEMORY

BOLARDO FLEXIBLE CON MEMORIA DE FORMA ◦ FLEXIBER PFOSTEN MIT FORMGEDÄCHTNIS



OPTION ◦ OPTIONAL ◦ OPCIÓN ◦ OPTIONAL

TP BOX 80 ▶ Ø 80
TP BOX 100 ▶ Ø 100

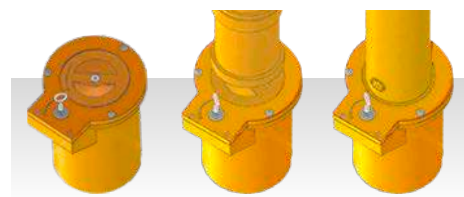
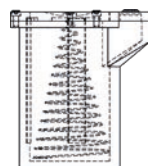
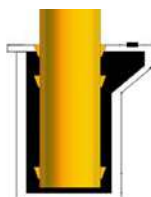

Caractéristiques techniques	Technical specifications	Características técnicas	Technische Daten	Résultat Result Resultado Ergebnis
Traitement anti UV	Anti UV treatment	Tratamiento anti UV	Anti-UV Behandlung	-
Dureté (Shore D)	Hardness (Shore D)	Dureza (Shore D)	Härte (Shore D)	46
Contrainte d'étirement constante à 100% (Mpa)	Tensile Stress at 100% Strain (MPa)	Limite elástico al 100% (MPa)	Beanspruchung bei konstanter Dehnung bis 100% (Mpa)	11.6
Résistance à la traction (MPa)	Tensile strength (Mpa)	Resistencia a la tracción (MPa)	Zugfestigkeit (Mpa)	33.9
Allongement à la rupture (%)	Elongation at break (%)	Elongación en la ruptura (%)	Bruchdehnung (%)	327
Résistance à la déchirure (KN/m)	Tear strength (KN/m)	Fuerza de desgarr (KN/m)	Reißfestigkeit (KN/m)	203

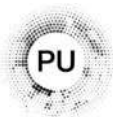
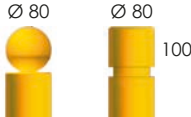

* < -20 °C - Nous consulter
Ask us ◦ Consultarnos
Uns konsultieren

RAL 9005	Autres couleurs : mini 5
RAL 6005	Others colors mini 5
RAL 7016	Otros colores : mini 5
RAL 8017	Andere Farben

1310 (A) (B) (C) (D) (E) (F) (G) (H) (I) (J) (K) (L) (M) (N) (O)

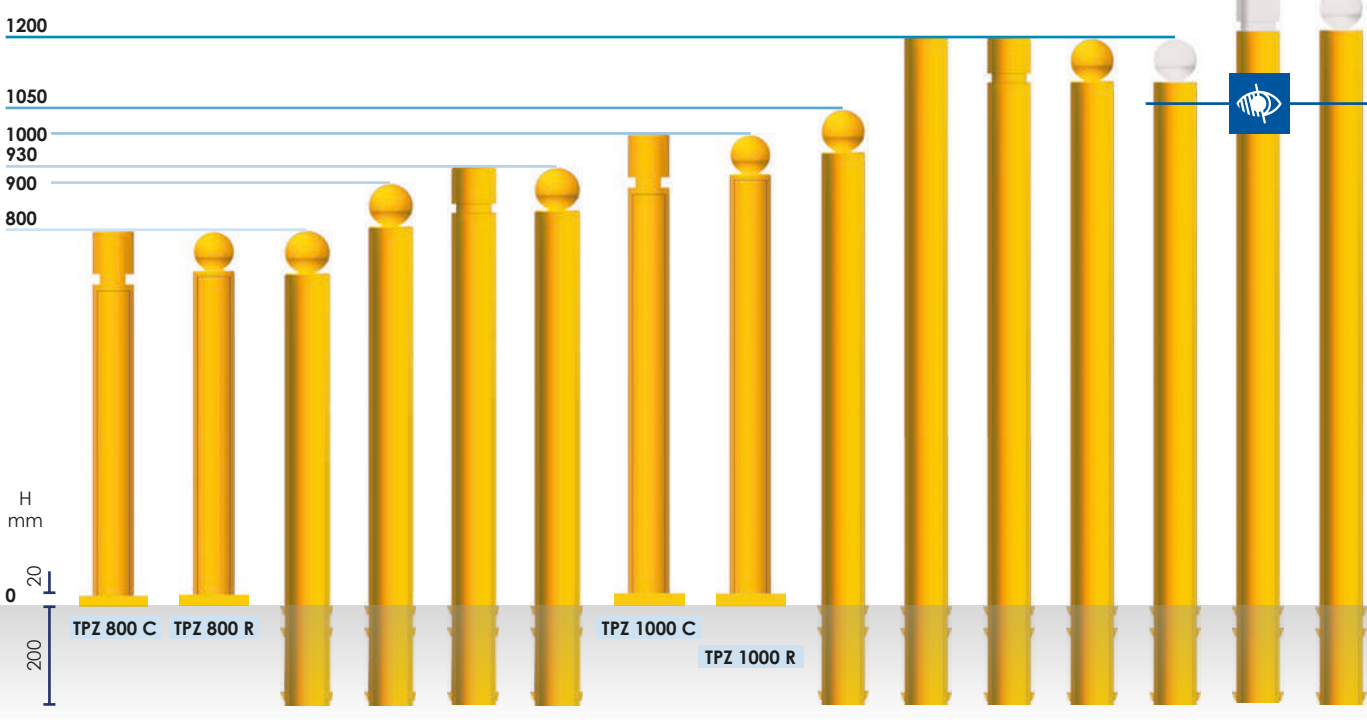

A H 800 mm	E H 930 mm	G H 1000 mm	K H 1200 mm	N H 1310 mm
TPZ 800 CN TPZ 800 CV	TPZ 1100 CN TPZ 1100 CV TPZ 1100 CG TPZ 1100 CM	TPZ 1000 CN TPZ 1000 CV TPZ 1000 C7044	TPZ 1280 C7024 TPZ 1280 C8011	TPZ 1500 CNB TPZ 1500 CGB TPZ 1500 CMB
			J H 1200 mm TPZ 1280 P	

B C H 800 mm	D H 900 mm	F H 930 mm	H H 1000 mm	I H 1050 mm	L M H 1200 mm	O H 1310 mm
TPZ 800 RN TPZ 800 RV TPZ 880 R6007	TPZ 980 RN TPZ 980 RG	TPZ 1100 RN TPZ 1100 RV TPZ 1100 RG TPZ 1100 RM	TPZ 1000 RN TPZ 1000 RV	TPZ 1080 RN TPZ 1080 RG	TPZ 1280 R7024 TPZ 1280 R8011 TPZ 1280 RB8011	TPZ 1500 RNB TPZ 1500 RGB TPZ 1500 RMB TPZ 1500 RB7024 TPZ 1500 RB8011

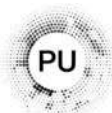

* < -20 °C - Nous consulter
Ask us o Consultarnos
Uns konsultieren

RAL 9005 Autres couleurs : mini 5
RAL 6005 Others colors : mini 5
RAL 7016 Otros colores : mini 5
RAL 8017 Andere Farben

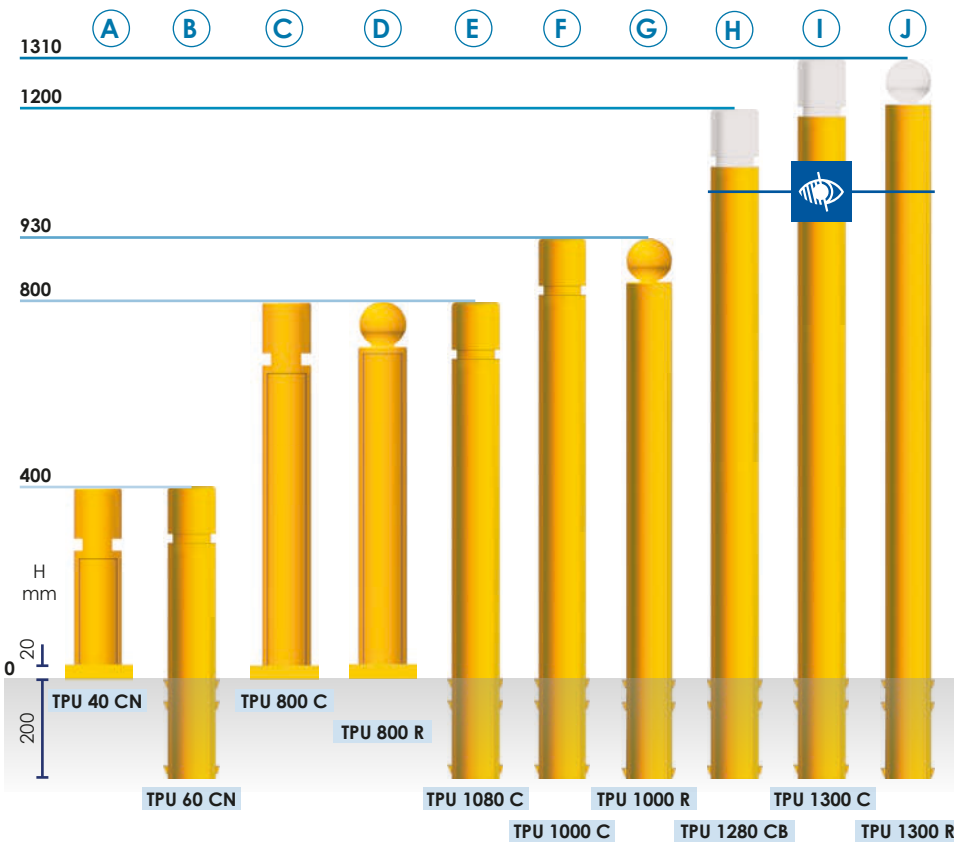

Option A	Option B	Option C	Option E	Option F	Option H	Option I
H 400 mm	H 400 mm	H 800 mm	H 800 mm	H 930 mm	H 1200 mm	H 1310 mm
TPU 40 CN	TPU 60 CN	TPU 800 CN TPU 800 CV	TPU 1080 CN TPU 1080 CV TPU 1080 C3004 TPU 1080 CM	TPU 1000 CN TPU 1000 CV TPU 1000 CA TPU 1000 CM	TPU 1280 CB6009	TPU 1300 CNB TPU 1300 CAB TPU 1300 CMB

Option D	Option G	Option J
H 800 mm	H 930 mm	H 1310 mm
TPU 800 RN TPU 800 RV	TPU 1000 RN TPU 1000 RV TPU 1000 RA TPU 1000 RM	TPU 1300 RNB TPU 1300 RAB TPU 1300 RMB

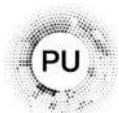

+ 50 °C
- 20 °C*

* < -20 °C - Nous consulter
Ask us o Consultarnos
Uns konsultieren



RAL 9005

RAL 7016 *

RAL 8017

Autres couleurs : mini 5
Others colors mini 5
Otros colores : mini 5
Andere Farben

Code	Ø mm
(B) TPU 40 CN	100
(A) TPU 60 CN	100
(D) TPU 100 BK	80 / 60
(D) TPU 100 GR	80 / 60
(D) TPU 100 MA	80 / 60
(G) TPU 130 BKB	60 / 40
(G) TPU 130 GRB	60 / 40
(G) TPU 130 MAB	60 / 40
(F) TPU 114 PA *	114
(E) TP ANTIQUE *	80
(C) TP 167 N	167 / 110
(H) TPZ 1280 P	80

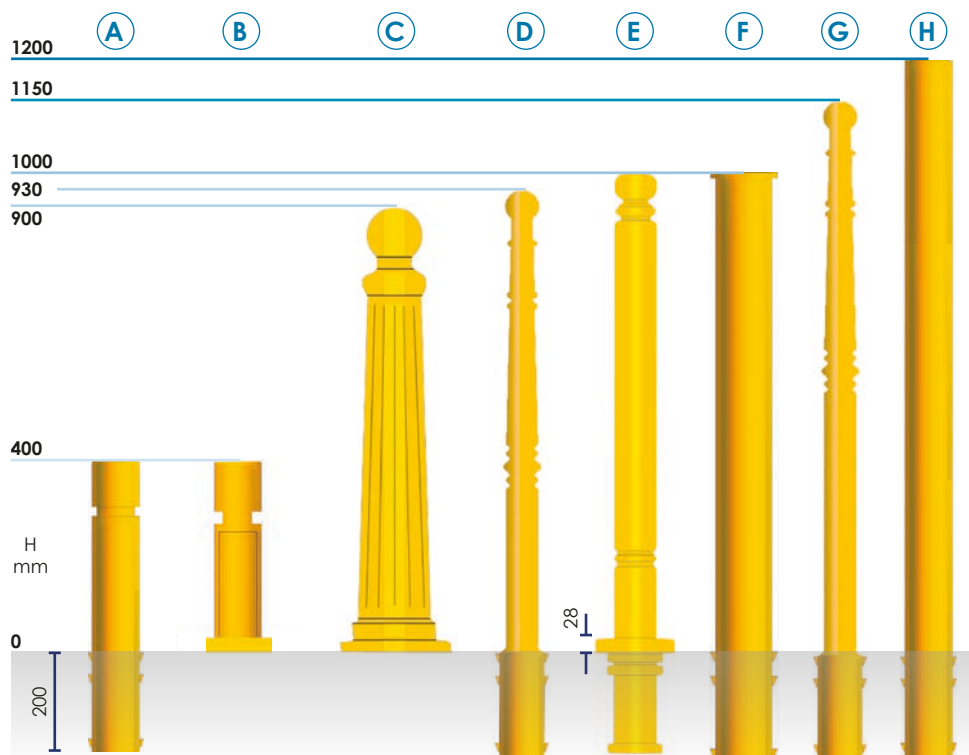

TPU 60 CN TPU 40 CN TP 167 N TPU 100 TPU 114 PA * TP ANTIQUE * TPY 130 TPZ 1280 P

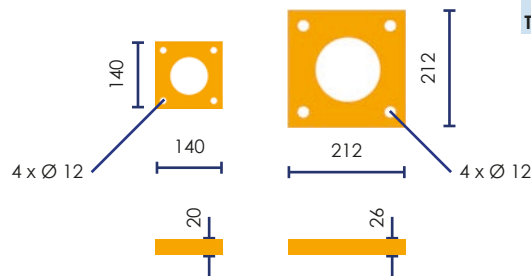

OPTION ○ OPTIONAL ○ OPCIÓN ○ OPTIONAL



TPU FIX 1 SB
Ø 12 x 80



TPU RING
TPZ RING



TPU TAPE
TPU / TPZ / TPY
TP ANTIQUE / TP 167



TP BOX 80
TPZ / TPY
TP ANTIQUE

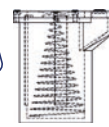

TP BOX 100
TPU

* Sauf Belgique ○ Except in Belgium ○ Salvo en Bélgica ○ Außer in Belgien

* Sauf ○ Except ○ Salvo ○ Außer TPU 114 PA : RAL 7043



PANNEAU SOLAIRE A LED ◦ SOLAR LED TRAFFIC SIGN
 PANEL DE TRAFICO CON LED ◦ VERKEHRSSCHILDER (SOLAR & LED)



▲ Autres dimensions : nous consulter. ◦ Other dimensions : ask us. ◦ Otras dimensiones : consultarnos. ◦ Andere Abmessungen: Kontaktieren Sie uns.

À PERSONNALISER ◦ TO CUSTOMIZE ◦ PERSONALIZAR ◦ ZU PERSONALISIEREN



Code	↗ mm
PNX-T50-XX	500
PNX-T70-XX	700
PNX-T100-XX	1000

Code	∅ mm
PNX-R 45 - XXX	450
PNX-R 65 - XXX	650
PNX-R 85 - XXX	850
PNX-R 105 - XXX	1050

Code	↗ mm
PNX-C50-XX	500 x 500
PNX-C70-XX	700 x 700

Code	∅ mm
PNX-H40-XX	400
PNX-H60-XX	600
PNX-H80-XX	800
PNX-H100-XX	1000

Code	↗ mm
PR-5070-XX	550 x 700

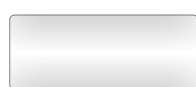

Code	↗ mm
PNX-M3-XX	300 x 150
PNX-M5-XX	500 x 200



Code	↗ mm
PNX-KC-XX	800 x 600



Code	∅ mm
PSTAT *	300

* Panneau lumineux électrique à usage grand public / fixations par vis ◦ Electric light panel for por private use
 Panel luminoso eléctrico para uso privado ◦ Elektrisches Lichtpaneel für den allgemeinen öffentlichen / Befestigung durch Schrauben



PANNEAU SOLAIRE A LED

SOLAR LED TRAFFIC SIGN ◦ PANEL DE TRAFICO CON LED ◦ VERKEHRSSCHILDER (SOLAR & LED)

- Panneau 3 en 1 : LED, panneau solaire et batterie
- Panneau solaire : 0,3 W / durée de vie 10 000 heures
- Batterie : # 18650 / 4400 mAh / 10 à 12 heures de fonctionnement sur batterie entièrement chargée
- LED : couleur (ø 5 mm / 0,04 w) blanc (ø 5 mm / 0,06 w)
- Nombre de LED en fonction de la taille / Clignotants 42/min
- Intensité lumineuse du début : 6000mcd
- Visibilité : 500M
- Niveau de protection : IP65
- Décoration : revêtement réfléchissant vinyle, Classe 2, revêtement EGP 3 M
- Cadre Inox / aluminium
- 2 rails à l'arrière pour la fixation
- Température de fonctionnement : - 10 / +45°C
- **Poteaux non inclus à la gamme**

- 3 in 1 panel: LED, solar panel and battery
- Solar panel: 0.3 W / lifetime 10,000 hours
- Battery: # 18650/4400 mAh / 10 to 12 hours of operation on fully charged battery
- LED: color (ø 5 mm / 0.04 w) white (ø 5 mm / 0.06 w)
- Number of LEDs according to the size / flashing 42/min
- Light intensity from the beginning: 6000mcd
- Visibility: 500M
- Protection level: IP65
- Decoration: vinyl reflective coating, Class 2, EGP coating 3 M
- Stainless steel / aluminum frame
- 2 rails at the back for fixing
- Operating Temperature : - 10 / +45°C
- **Posts are not included in our range**

- Panel 3 en 1: LED, panel solar y batería
- Panel solar: 0,3 W / vida útil 10.000 horas
- Batería: # 18650/4400 mAh / 10 a 12 horas de funcionamiento con una batería completamente cargada
- LED : color (ø 5 mm / 0,04 w) blanco (ø 5 mm / 0,06 w)
- Cantidad de LEDs según el tamaño / parpadeo 42/min
- Intensidad de la luz desde el principio: 6000mcd
- Visibilidad: 500M
- Nivel de protección: IP65
- Decoración: revestimiento reflectante de vinilo, Clase 2, revestimiento EGP 3 M
- Marco de acero inoxidable / aluminio
- 2 rieles en la parte trasera para la fijación
- Temperatura de funcionamiento : - 10 / +45°C
- **Postes no incluidos a la gama**

- 3-in-1-Panel: LED, Solarpaneel und Batterie
- Solarpaneel: 0.3 W / Lebensdauer 10.000 Stunden
- Akku: # 18650/4400 mAh / 10 bis 12 Stunden voll aufgeladener Akku
- LED: Farbe (ø 5 mm / 0.04 w); weiß (ø 5 mm / 0.06 w)
- Anzahl LEDs je nach Größe / Blinker 42/Min
- Anfangslichtintensität: 6000mcd
- Sichtbarkeit : 500M
- Schutzniveau : IP65
- Dekoration: reflektierende Vinyl-Beschichtung, Class 2, EGP 3 M Beschichtung
- Rahmen Inox / Aluminium
- 2 Schienen hinten zur Befestigung
- Betriebstemperatur: - 10 / +45°C
- **Posten nicht im Sortiment enthalten**



PNX R



PNX T



PNX C



PNX H *



INCLUS
INCLUDED ◦ INCLUIDO ◦ INKLUSIVE

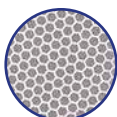
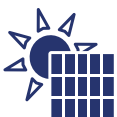
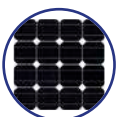

classe 2

OPTION
OPTIONAL ◦ OPCIÓN ◦ OPTIONAL



FIXATIONS NON INCLUSES ◦ **FIXINGS NOT INCLUDED**
FIJACIONES NO INCLUIDAS ◦ NICHT INKL. BEFESTIGUNGEN

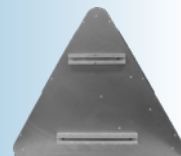
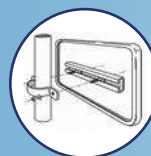

* Panneau solaire déporté selon dimensions panneau ◦ Remote solar panel according to traffic sign dimensions
Panel solar remoto según dimensiones de la señal ◦ Fernsolarpanel nach Panelabmessungen



POD

BANDE DE GUIDAGE ◦ TACTILE GUIDE STRIPS
BANDA DE SEÑALIZACIÓN
BODENLEITSTREIFEN



Code	kg	Surface m ² Surface Superficie Oberfläche
POD 104 BA	1,6	
POD 104 NR	1,6	0,2
POD 104 JA	1,6	



OPTION OPTIONAL ◦ OPCIÓN ◦ OPTIONAL

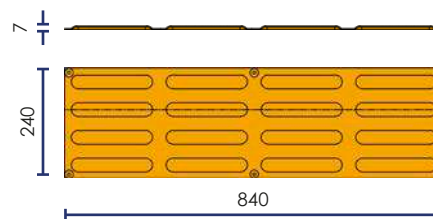

Code	kg	Surface m ² Surface Superficie Oberfläche
POD 104 ALU	1,2	0,2



6 x Ø 6 mm, non fourni ◦ not supplied ◦ no incluido ◦ nicht enthalten

Code	kg
POD 29 LIS	0,30
POD 29 RE	0,30



POD 29 LIS



POD 29 RE

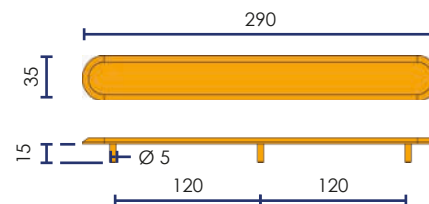

OPTION OPTIONAL ◦ OPCIÓN ◦ OPTIONAL

Gabarit de pose ◦ Laying template
 Planfilla de instalación ◦ Verlegeschablone

POD 29 TOOL
x 12

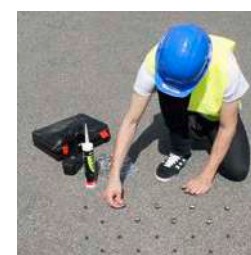



POD

CLOU PODOTACTILE ◦ TACTILE STUDS
CLAVOS PODOTÁCTILES
TAKTILE BODENLEITLINIEN UND NOPPEN



Code		
POD 25 STR	100	0,02
POD 25 LIN	100	0,02
POD 25 LINNR	100	0,02
POD 25 GOSTR	100	0,02



POD 25 STR



POD 25 LIN



POD 25 LINNR



POD 25 GOSTR

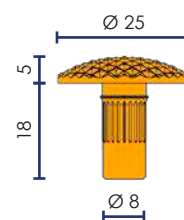

OPTION OPTIONAL ◦ **OPCIÓN** ◦ **OPTIONAL**

Gabarit de pose ◦ Laying template
 Plantilla de instalación
 Verlegeschablone

► **POD 25**
POD TOOL 4060
 x 99 588 x 400

Pour une longueur de 1 ml :
 Largeur 420 mm = 149 clous
 Largeur 620 mm = 216 clous



PODSEAL
 ► p. 281

Code		
POD 35 LIS	100	0,03
POD 35 RE	100	0,03
POD 35 STR	100	0,03



POD 35 LIS

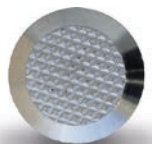

POD 35 RE

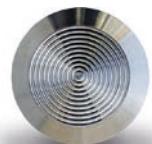

POD 35 STR

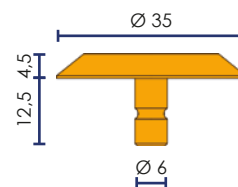

OPTION OPTIONAL ◦ **OPCIÓN** ◦ **OPTIONAL**

Gabarit de pose ◦ Laying template
 Plantilla de instalación
 Verlegeschablone

► **POD 35**
POD 35 TOOL
 x 120 1085 x 500



PODSEAL
 ► p. 281

Code			Surface m ² Surface Superficie Oberfläche
POD 42 CL		2	0,32
POD 81 CL		3,4	
POD 81 JA		3,4	0,50
POD 81 NR		3,4	

CAOUTCHOUC
RUBBER
CAUCHO
KAUTSCHUK

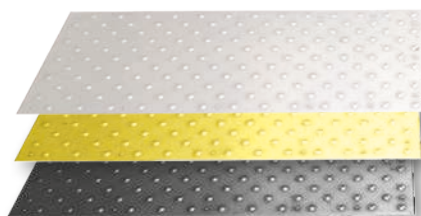

OPTION ◦ **OPTIONAL** ► **POD 42**
OPCIÓN ◦ **OPTIONAL**



PODGLUE
 5 kg (± 1 kg/m²)
PODGLUE 2
 2 kg (± 1 kg/m²)

Code		Surface m ² Surface Superficie Oberfläche
POD 81 ALU	2,2	0,50



Code		Surface m ² Surface Superficie Oberfläche
POD 304 INOX *	7,5	
POD 316 INOX *	7,5	0,50



► **POD 81 / POD 304 / POD 316** : 810 x 620
POD 42 : 770 x 420

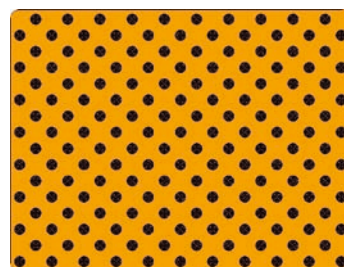

* Sur commande ◦ Under request ◦ bajo pedido ◦ Auf Bestellung

POD 81 ALU / POD 304 / POD 316 : non fourni ◦ not supplied ◦ no incluido ◦ nicht enthalten



METROPOLITAIN

14





PDM

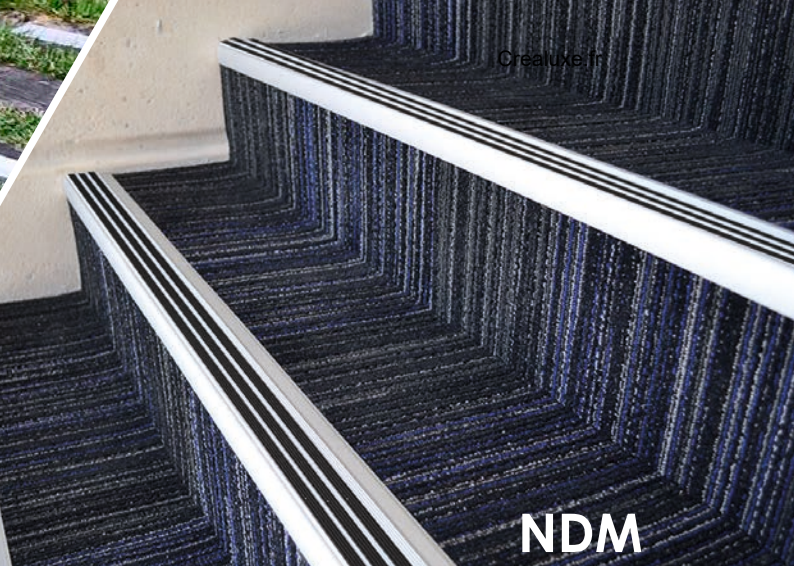

NDM

NEZ DE MARCHE ANTIDÉRAPANT ○ **NON-SLIP STAIR NOSING**
PERFIL ANTIDESLIZANTE PARA PELDAÑOS ○ **RUSTCHFEST TREPPENKANTENPROFIL**



Code			
NDM 900 PVC	●	3 x 5 mm	0,80
NDM 900 BK	●		0,80
NDM 900 FLUO	●		0,80
NDM 1300 PVC	●	4 x 5 mm	1,20
NDM 1300 BK	●		1,20
NDM 1300 FLUO	●		1,20

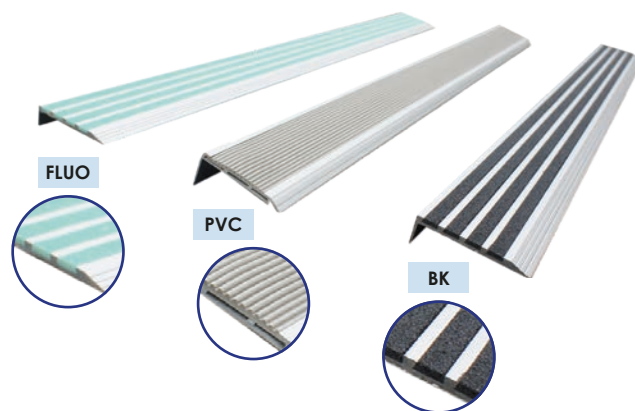

non fourni ○ not supplied ○ no incluido ○ nicht enthalten

NDM 900



900



NDM 1300



1300

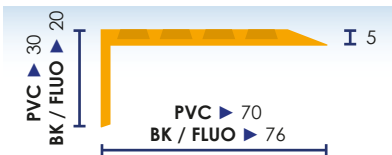
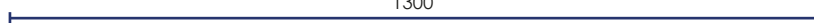

PLAT DE MARCHE ○ **STAIRS PAD**
PERFIL ANTIDESLIZANTE PARA PELDAÑOS ○ **TREPPENKANTEN**



Code			
PDM 900 PVC	●	3 x 5 mm	0,80
PDM 900 BK	●		0,80
PDM 1300 PVC	●	4 x 5 mm	1,10
PDM 1300 BK	●		1,10

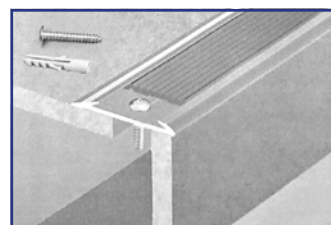
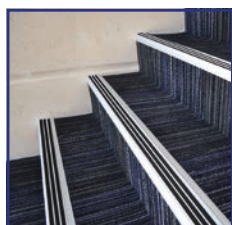

non fourni ○ not supplied ○ no incluido ○ nicht enthalten

PDM 900



900



PDM 1300



1300

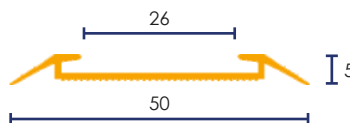
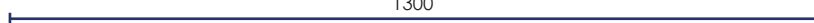

OPTION
 OPCIÓN
 OPTIÖN



RQ GLUE





PARKSTOP

BUTÉE DE PARKING

RUBBER PARKING STOP ◦ TOPE DE RUEDAS EN CAUCHO ◦ PARKPLATZBEGRENZUNG



Code			
PARKSTOP 50	4	2	6,50
PARKSTOP 90	4	2	8,00
PARKSTOP 130	4	4	12,50
PARKSTOP 180	4	4	16,00

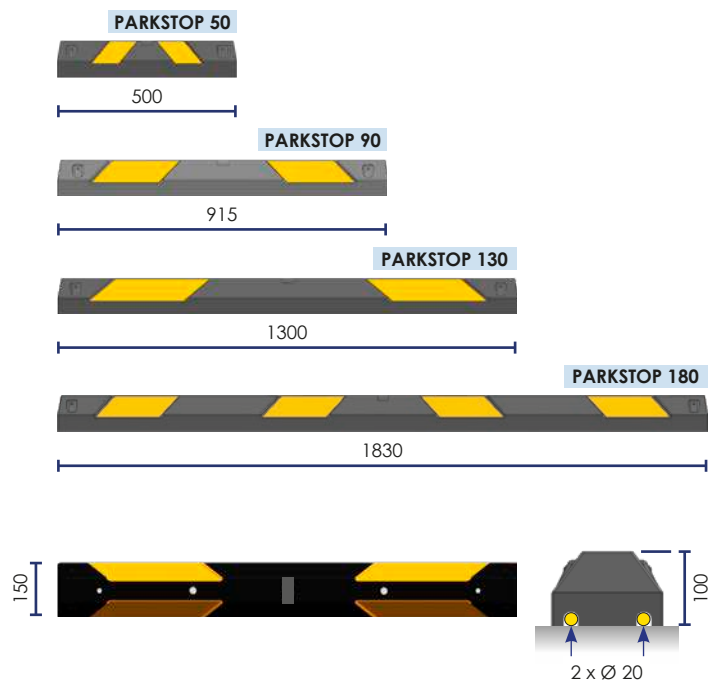

OPTION ◦ OPTIONAL ◦ OPCIÓN ◦ OPTIONAL

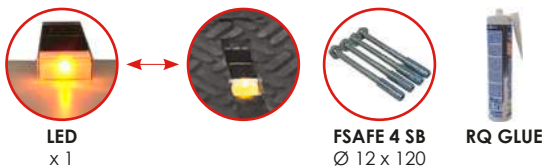

INCLUS ◦ INCLUDED ◦ INCLUIDO ◦ INKLUSIVE





PARKPLACE

TPX

BUTÉE DE PARKING HAUTE VISIBILITÉ

HIGH VISIBILITY PROTECTION GUARD

TOPE DE RUEDAS ALTA VISIBILIDAD ○ PARKPLATZBEGRENZUNG



Code		
PARKPLACE 18 BU		14,40
PARKPLACE 18 JA		14,40
PARKPLACE 18 WH		14,40
PARKPLACE 18 BK		14,40

* Peinture ○ Painting ○ Pintura ○ Farbe

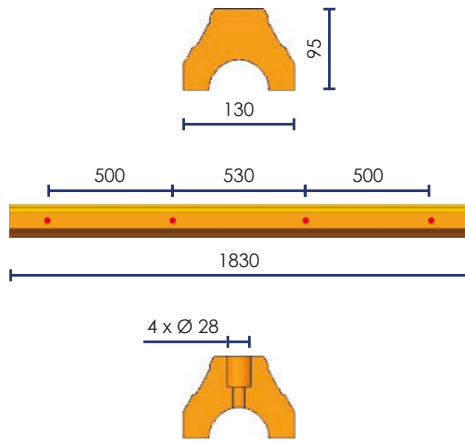

OPTION OPTIONAL ○ OPCIÓN



BUTÉE FLEXIBLE À MÉMOIRE DE FORME

FLEXIBLE PROTECTION BARS

TOPES DE PROTECCIÓN FLEXIBLES

FLEXIBEL RAMMSCHUTZBALKEN MIT FORMGEDÄCHTNIS

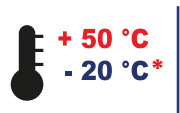
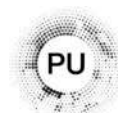

Code		
TPX 800 NJ	798 x 150 x 120	2,4
TPX 1200 NJ	1180 x 150 x 120	4,3
TPX 2000 NJ	1998 x 150 x 120	7,2

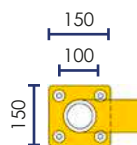
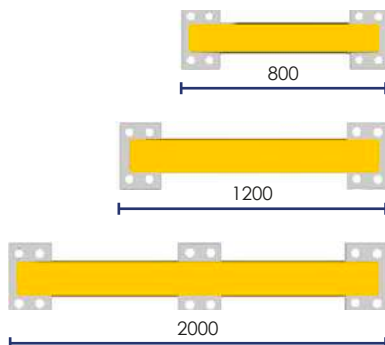

Capuchons ○ Caps
Tapas ○ Kappen

OPTION
OPCIÓN
OPTIONAL



TPU FIX 1 SB
Ø 12 x 80

* < 20 °C - Nous consulter ○ Ask us ○ Consultarnos ○ Uns konsultieren



PARKLANE

BORDURES DE BALISAGE
WARNING BORDER
TOPE DE SEÑALIZACIÓN ◦ **TRENNBALKEN**



Code		
PARKLANE 1200	4	12,0
PARKLANE 1 MA	-	0,9
PARKLANE 1 FE	-	1,2

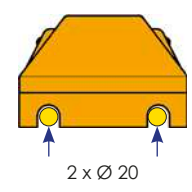

INCLUS ◦ **INCLUDED** ◦ **INCLUIDO** ◦ **INKLUSIVE**

2 x Ø 20

OPTION ◦ **OPTIONAL** ◦ **OPCIÓN** ◦ **OPTIONAL**

LED

FS SAFE 4 SB
Ø 12 x 120

SPIKES
Ø 12 x 300



GALVANISATION SUR COMMANDE
GALVANISATION : TO ORDER
GALVANIZADO : BAJO PEDIDO
VERZINKT: AUF ANFRAGE



PARKSTEEL



PARK

BUTÉE DE PROTECTION ACIER ○ STEEL PROTECTION BAR

TOPE DE PROTECCIÓN DE ACERO

PARKPLATZBEGRENZUG AUS STAHL



PEINTURE ÉPOXY
POWDER PAINTING
PINTURA EPOXICA
EPOXY FARBE

PARK

Code	L		
PARK 6565 NJ	650 x 650	6	8,00
PARK 400 NJ	400	4	3,50
PARK 800 NJ	800	4	4,50
PARK 1200 NJ	1200	4	6,80

Ø 76 mm



OPTION ○ OPTIONAL ○ OPCIÓN ○ OPTIONAL



BAR FIX 1 SB (x 1)



BAR FIX 304 SB (x 4)

PARKSTEEL

Code	L		
PARKSTEEL 80	830	4	6,70
PARKSTEEL 120	1230	4	8,40
PARKSTEEL 200	2030	6	14,00
PARKORNER	185 x 185	4	5,00

Ø 75 mm

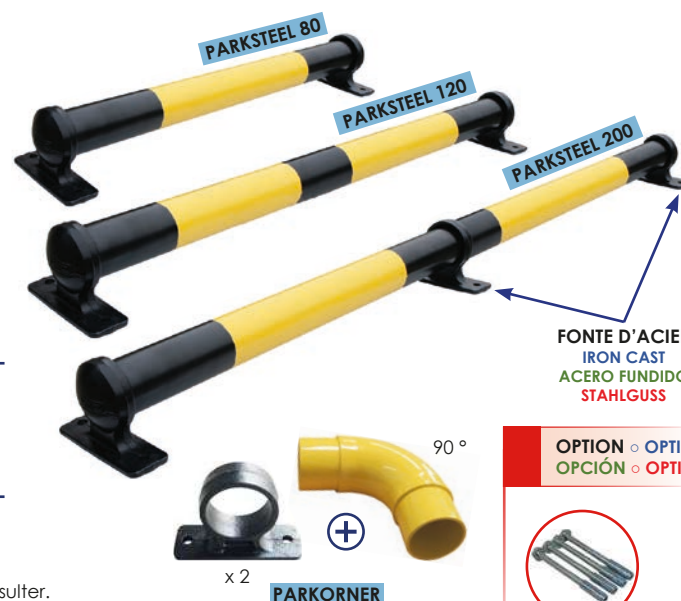

FONTE D'ACIER
IRON CAST
ACERO FUNDIDO
STAHLGUSS

OPTION ○ OPTIONAL
OPCIÓN ○ OPTIONAL



FSAFE 4 SB
Ø 12 x 120

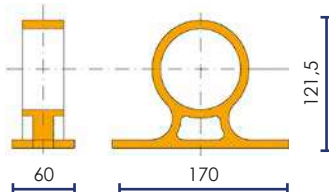

Ne pas installer en milieu salin ou Hydrocarbure. Nous consulter.
Do not install in saline or Oil environment. Contact us.
No lo instale en un ambiente salino o hidrocarburo. Consúltenos.
Soll nicht in Salz oder Kohlenstoff Umgebung installiert werden, /uns Konsultieren.



BUT 1200

BUT 800

BUTÉE POIDS LOURD & CHARIOT ÉLEVATEUR
TRUCK AND FORKLIFT BUMPER
TOPE PARA CAMIONES Y CARRETILLAS
LKW-PARKPLATZBEGRENZUNG



BUT 800



Code		
BUT 800	6 *	25,50
BUT 800 FIX	6 **	27,80

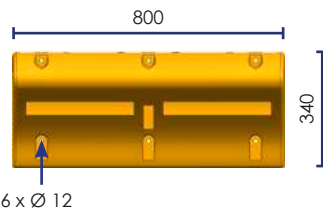
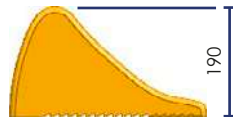

INCLUS ◦ INCLUDED
INCLUIDO ◦ INKLUSIVE

BUT 800 FIX

** FIXSAFE
 Ø 12 x 120

OPTION ◦ OPTIONAL ◦ OPCIÓN ◦ OPTIONAL

* FSFAE 2 SB
 Ø 12 x 120

* SPIKES
 Ø 12 x 300

LED

FLASH

BUT 1200



Code		
BUT 1200	3 *	20,00
BUT 1200 FIX	3 **	22,30

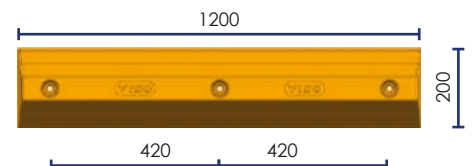
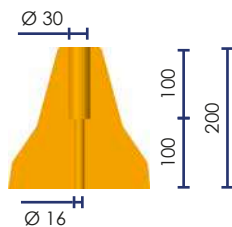

INCLUS ◦ INCLUDED
INCLUIDO ◦ INKLUSIVE

BUT 1200 FIX

** FIX 253 SB
 Ø 16 x 250

OPTION ◦ OPTIONAL
OPCIÓN ◦ OPTIONAL

* FIX 253 SB
 Ø 16 x 250

* SPIKES 253 SB
 Ø 14 x 350



BUT 800 GAL



BAR CAM 3

BUTÉE ET GUIDE ROUE POIDS LOURD

TRUCK BUMPER ◦ TOPE PARA CAMIONES
LKW-PARKPLATZBEGRENZUNG



BUT 800 GAL



Code		
BUT 800 GAL	12 *	24,00
BUT 800 GALFIX	12 **	27,40

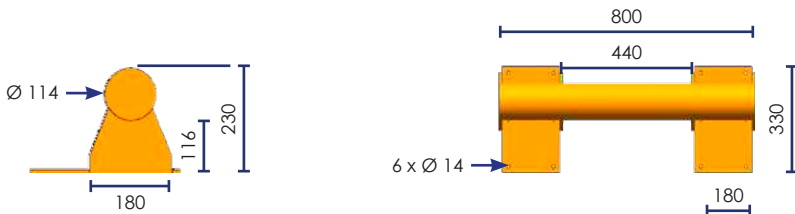

INCLUS INCLUDED ◦ INCLUIDO ◦ INKLUSIVE	OPTION OPTIONAL ◦ OPCIÓN ◦ OPTIONAL
<p>BUT 800 GALFIX</p> <p>** FSAFE 4 SB Ø 12 x 120</p>	<p>* FSAFE 4 SB Ø 12 x 120</p> <p>* SPIKES Ø 12 x 300</p>

BAR CAM 3



Code		
BAR CAM 3	2 x 18 = 36 *	2 x 22,0 = 44
BAR CAM 3FIX	2 x 18 = 36 **	2 x 27,5 = 55

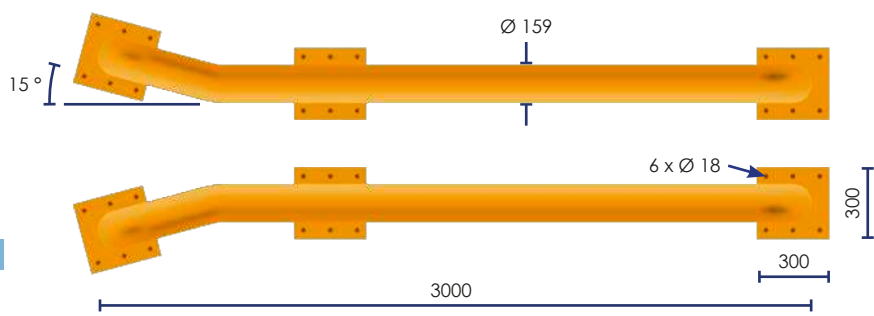

INCLUS INCLUDED ◦ INCLUIDO ◦ INKLUSIVE	OPTION OPTIONAL ◦ OPCIÓN ◦ OPTIONAL
<p>BAR CAM 3FIX</p> <p>** BAR CAM FIX 6 SB Ø 16 x 200</p>	<p>* BAR CAM FIX 6 SB Ø 16 x 200</p>

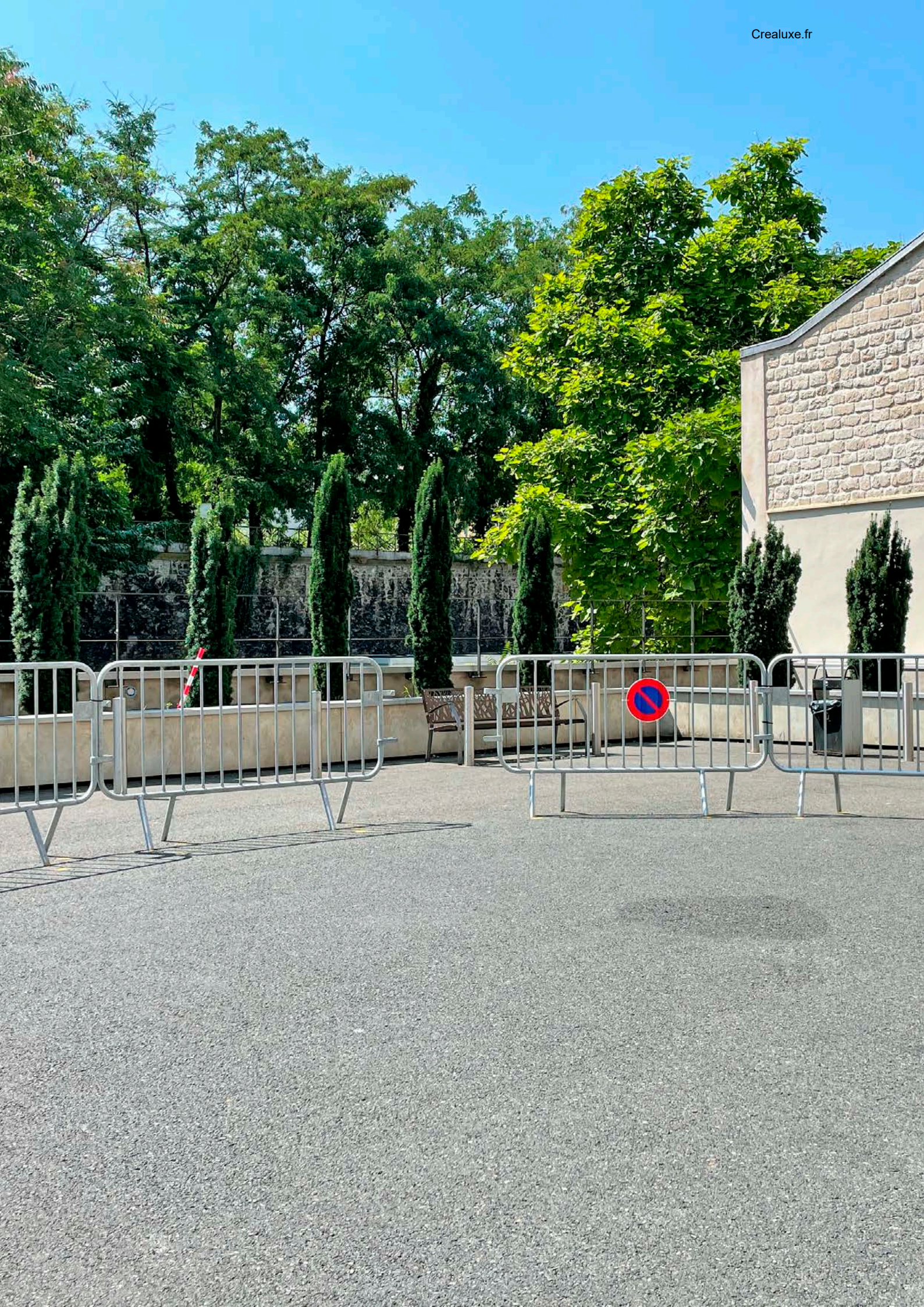



BARPOL



BARPLA

BARRIÈRE DE POLICE ACIER GALVANISÉ À CHAUD

CROWD CONTROL BARRIER

VALLA DE SEGURIDAD DE ACERO o ABSPERRUNG AUS VERZINKTEM STAHL



BAR 14 PLA

BAR 18 PLA

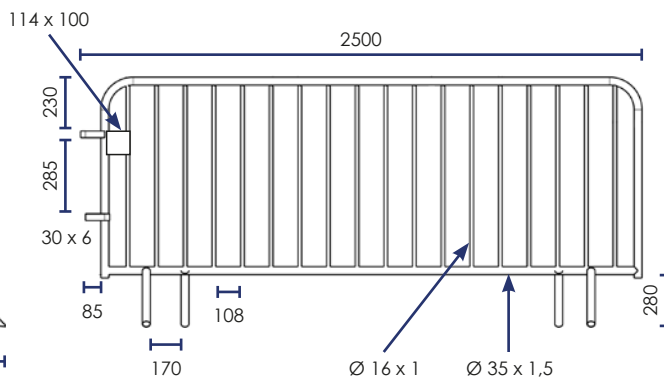
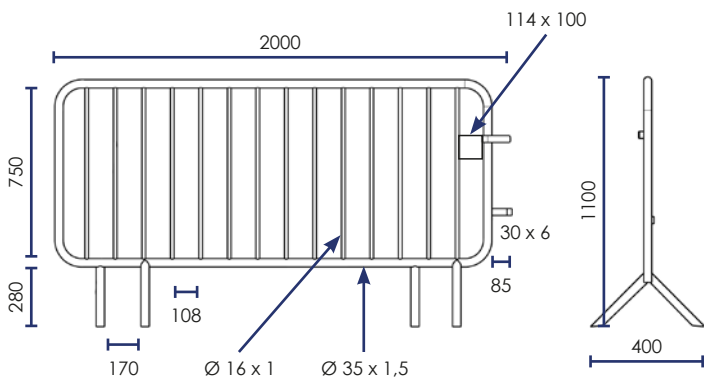

Code	L		kg
BAR 14 PLA	2000	14	14,00
BAR 18 PLA	2500	18	17,00

• Autre design sur commande o customized barrier under request
 Personalización bajo pedido o Maßgeschneiderte Barrieren

• Sans plaque : sur commande, nous consulter.
 Without plate, ask us.
 Sin placa, consultarnos.
 Plattenlos: auf Bestellung, uns konsultieren.

Code	L		kg
BAR 14 POL	2000	14	14,00
BAR 18 POL	2500	18	17,00



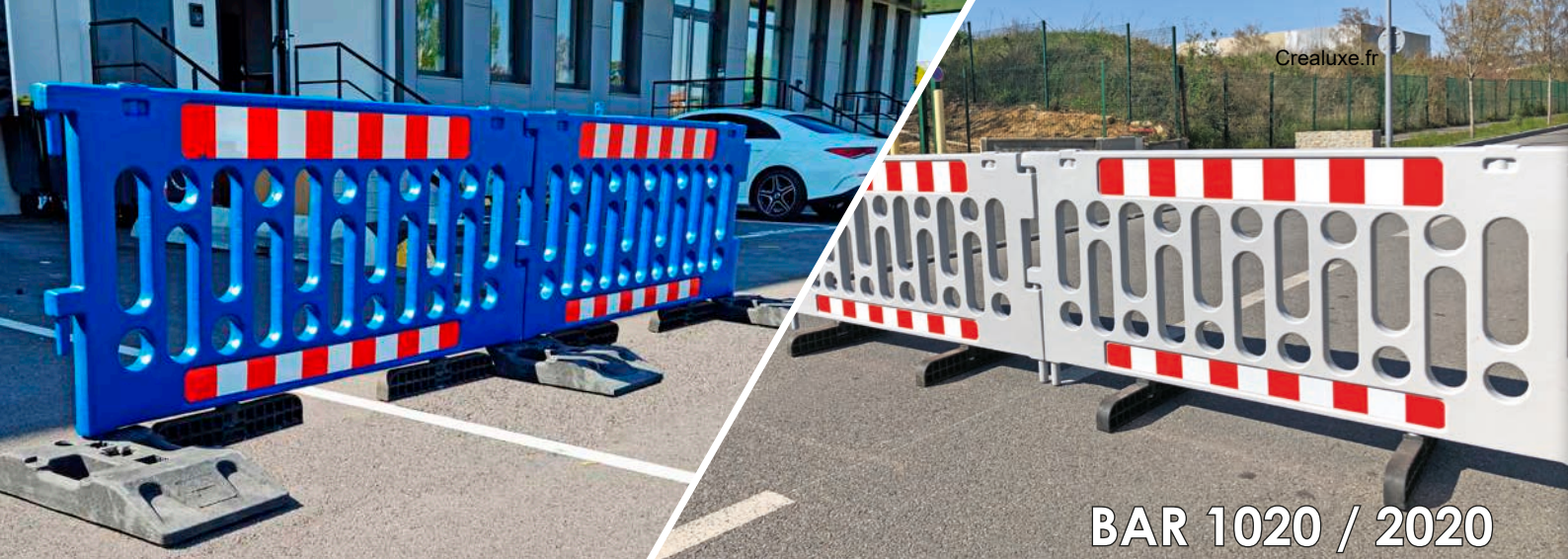

BAR 1020 / 2020

BARRIÈRES POLYPROPYLENE POLYPROPYLENE BARRIERS BARRERAS DE POLIPROPILENO ◦ SPERRGITTER

Classe 1 ◦ Class 1
Clase 1 ◦ Klasse 1

 Autres couleurs : mini 50
Others colors : mini 50
Otros colores : mini 50
Andere Farben : Mini 50



Code	
BAR 2020 GR	RAL 7035
BAR 2020 OR	RAL 2004



Pieds intégrés
With heavy feet
Pies integrados
Integrierte Füße

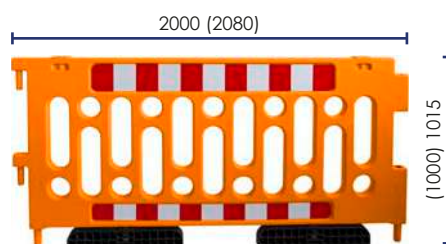
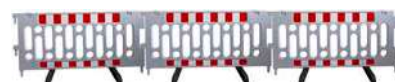

BAR 2020 OR

Code	
BAR 2020 GR SP	RAL 7035
BAR 2020 OR SP	RAL 2004



Pour base
For base
Para base
Für sockel

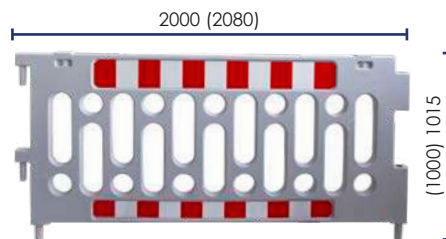

BAR 2020 GR SP

Code	
BAR 1020 GR	RAL 7035
BAR 1020 OR	RAL 2004



Pour base
For base
Para base
Für sockel

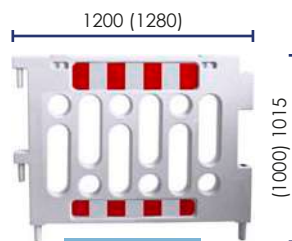

BAR 1020 GR

OPTION ◦ OPTIONAL ◦ OPCIÓN ◦ OPTIONAL

BASE 2500

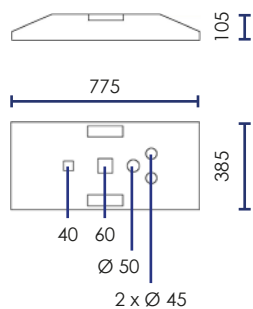

BASE 310

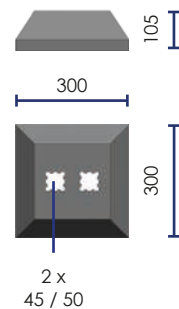

Poignée intégrée
Built in handle
Mango incorporado
Handgriff

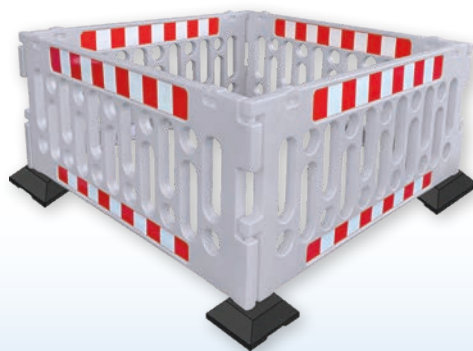

1200 X 1200

BAR 104 OR



BAR 134 OR



BAR 104 GR

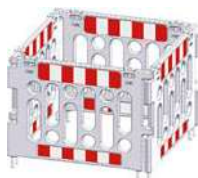

BAR 134 GR



2000 X 2000

BAR 204 OR



BAR 234 OR



BAR 244 OR



BAR 204 GR



BAR 234 GR



BAR 244 GR



OPTION ◦ OPTIONAL ◦ OPCIÓN ◦ OPTIONAL

Ø 180

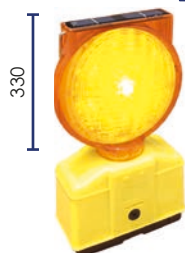

LAMP SOL



360°



3 modes d'éclairage
3 light modes
3 modos de iluminación
3 Positionen



x 2
BARTAPE 2
Classe 2



POTEAU INOX

STAINLESS STEEL POSTS ◦ POSTES DE ACERO INOXIDABLE ◦ EDELSTAHLPOSTEN

Code	Ø mm		kg
POT 89 316	89	Ø 170	3,90
POTS 89 316			5,00
POT BOX 89			135 x 135 H 300
POT 159 316	159	Ø 240	11,50
POTS 159 316			12,20
POT BOX 159			175 x 145 H 300

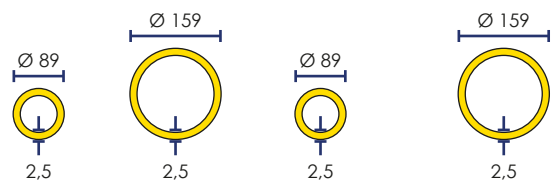

Fourni
Supplied
Includido
Inklusive



POT BOX 89 / 159



POTS 89 316 POTS 159 316



POTS 89 316



POTS 159 316



POTS 159 316

POTEAU ACIER

STEEL POSTS ◦ POSTES DE ACERO ◦ STAHLPOSTEN

Code		kg
POT 800 NJ ▲		7,3
POT 800 RB ▲		
POT 800 GAL		
POTS 800 NJ ▲		5,3
POTS 800 RB ▲		
POTS 800 GAL		



POT

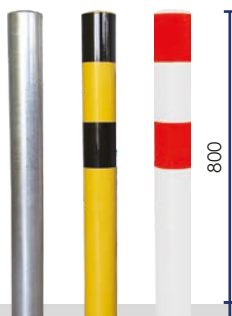
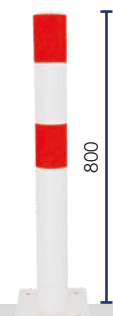

POTS



Ne pas installer en milieu salin ou Hydrocarbure. Nous consulter.
Do not install in saline or Oil environment. Contact us.
No lo instale en un ambiente salino o hidrocarburo. Consúltanos.
Soll nicht in Salz oder Kohlenstoff Umgebung installiert werden,
/uns Konsultieren.

OPTION ◦ OPTIONAL ◦ OPCIÓN ◦ OPTIONAL



BAR FIX 1 SB



BAR FIX 304 SB



- ▶ POT 2 RESB
- ▶ POT 2 ORSB
- ▶ POT 2 WHSB
- ▶ POT 2 BUSB
- ▶ POT 2 VERSB

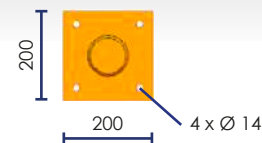





POT 757 GAL

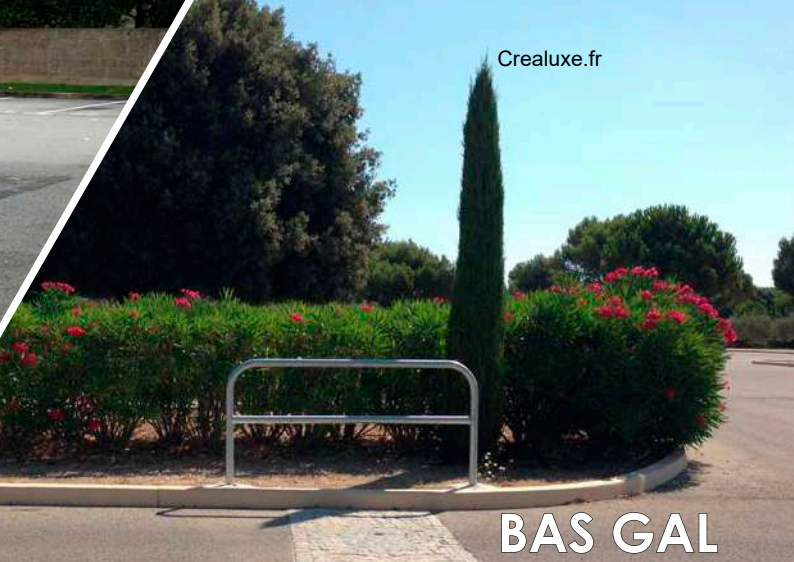

BAS GAL

BARRIÈRE À SCELLER ◦ **BARRIERS TO EMBED**
BARRERAS PARA EMPOTRAR ◦ **RAMMSCHUTZBÜGEL ZU VERSIEGELN**

 GALVA |
  PEINTURE ÉPOXY
 POWDER PAINTING
 PINTURA EPOXICA
 EPOXY FARBE

Ø 40 mm





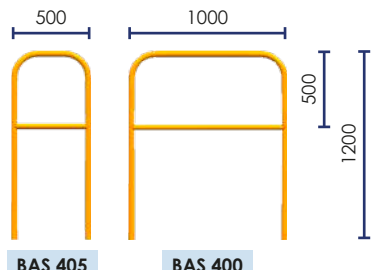



Code		
BAS 400 GAL		5,1
BAS 405 GAL		4,0



Ø 60 mm



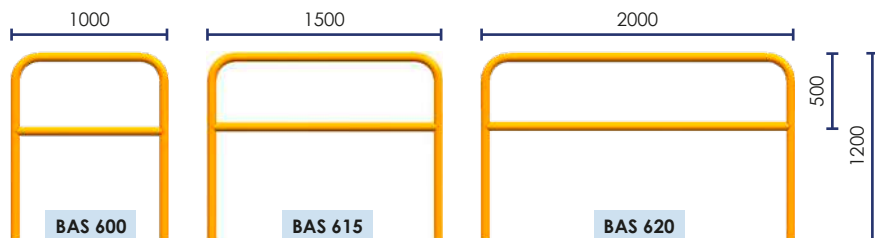

Code		
BAS 600 V 		8,5
BAS 600 GAL		8,5
BAS 615 GAL		11,8
BAS 620 GAL		12,7



Ø 40 mm





BAS 2000 V  3,50



Ø 40 mm





POT 76 R  4,00



Ø 40 mm



POT 162 V  3,50



Ø 60 mm



GALVA

POT 757 GAL  8,00

POTS 600 GAL  9,50

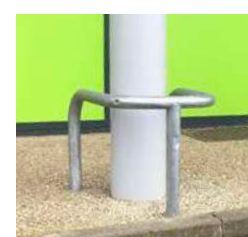

 Ne pas installer en milieu salin ou Hydrocarbure. Nous consulter. ◦ Do not install in saline or Oil environment. Contact us.
 No lo instale en un ambiente salino o hidrocarburo. Consúltenos.
 Soll nicht in Salz oder Kohlenstoff Umgebung installiert werden. /uns Konsultieren.

* Autres couleurs sur commande ◦ Other colors to order ◦ Otros colores bajo pedido ◦ Andere farben auf anfrage



BAS

BASOL

BBASE

 <p>BAS SIM GAL</p>	<p>BAS 40 SIM GAL Ø 40 mm</p> 	<p>BAS 60 SIM GAL Ø 60 mm</p> 
	<p>BAS 40 DOU GAL</p> 	<p>BAS 60 DOU GAL</p> 
 <p>BASOL GAL</p>	<p>BASOL 40 GAL</p> 	<p>BASOL 60 GAL</p> 
	<p>BASOL 40 DO GAL</p> 	<p>BASOL 60 DO GAL</p> 
 <p>BBASE</p>	<p>BBASE 40</p> 	<p>BBASE 60</p> 
	<p>BBASE 40 DOU</p> 	<p>BBASE 60 DOU</p> 



BAR GAL

BAR INOX

BARRIÈRE À FIXER

BARRIERS TO FIX ◦ BARRERA CON BASE ◦ RAMMSCHUTZBÜGEL MIT PLATTE

Code		
BAR 500 GAL	500 x 250	4,00

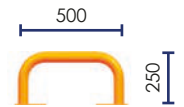
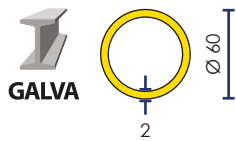

Code		
BAR 400 INOX	1000 x 1000	6,80
BAR 415 INOX	1500 x 1000	8,50
BAR 420 INOX	2000 x 1000	9,60

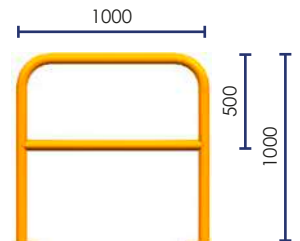

Code		
BAR 400 GAL	1000 x 1000	6,80
BAR 415 GAL	1500 x 1000	8,50
BAR 420 GAL	2000 x 1000	9,60

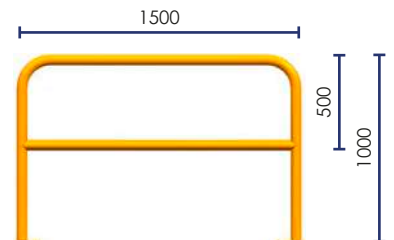
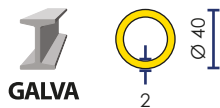

Code		
BAR 600 GAL	1000 x 1000	9,70
BAR 615 GAL	1500 x 1000	12
BAR 620 GAL	2000 x 1000	13,8

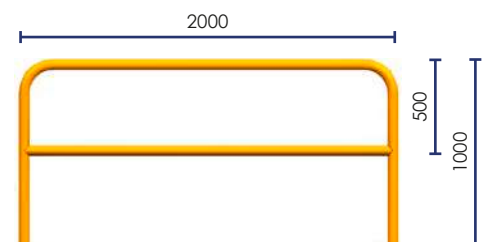
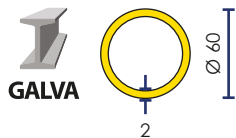

Bords arrondis
Rounded edges
Bordes redondeadas
Abgerundete Ecken



Espace limité entre 2
Limited space between 2
Espacio limitado entre 2
Begrenzter Raum zwischen 2

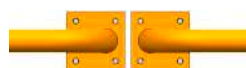

Autres couleurs ► p. 134 ◦ Other colors ► p. 134
Otros colores ► p. 134 ◦ Andere farben ► p. 134

OPTION ◦ OPTIONAL ◦ OPCIÓN ◦ OPTIONAL



BAR FIX 1 SB



BAR FIX 8 SB



BAR FIX 304 SB

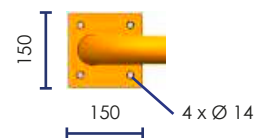



STOPOST

STOPCAR

POTEAU DE PARKING RABATTABLE

FOLDING PARKING POST ◦ POSTE DE APARCAMIENTO ABATIBLE ◦ KIPP-PFOSTEN



PEINTURE ÉPOXY
POWDER PAINTING
PINTURA EPOXICA
EPOXY FARBE

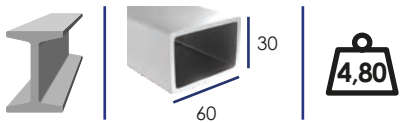

Code	
STOPOST	11



INCLUS ◦ INCLUDED ◦ INCLUIDO ◦ INKLUSIVE

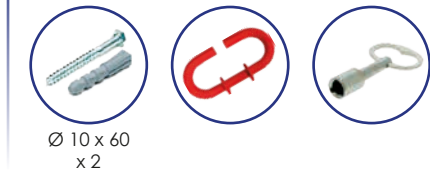

ARCEAU DE PARKING AVEC CADENAS ◦ PARKING HOOP WITH PADLOCK

BARRERA DE APARCAMIENTO CON CANDADO ◦ PARKBÜGEL MIT SCHLOSS

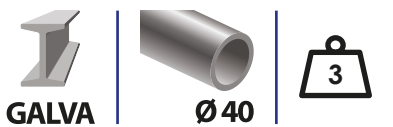

Code	
STOPCAR	
STOPCAR 50	

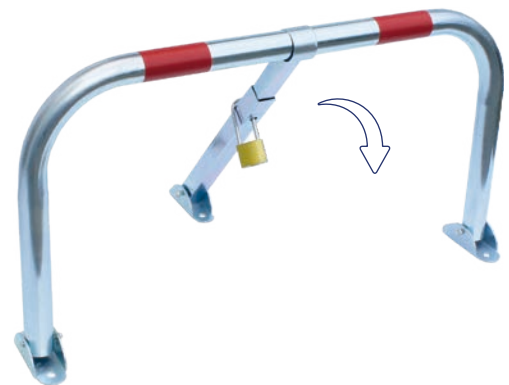

INCLUS
INCLUDED ◦ INCLUIDO ◦ INKLUSIVE

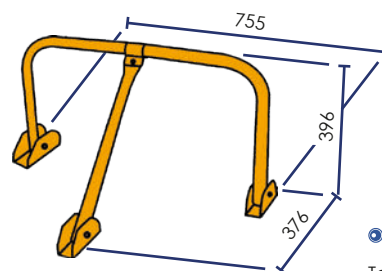

Tous les arceaux d'une commande ont le même cadenas
All the parking hoop of an order have the same padlock
Todas las barreras de un pedido tienen el mismo candado
Alle Parkbügel einer Bestellung haben das gleiche Vorhängeschloss



STOPWHEEL



STOPRO

STOPWHEEL



ZINGUÉ
ZINC
CINCADO
VERZINKTEM

Code	Key icon
STOPWHEEL	
STOPWHEELPASS *	
STOPWHEEL 50	
STOPWHEEL 100	
STOPWHEEL 114	

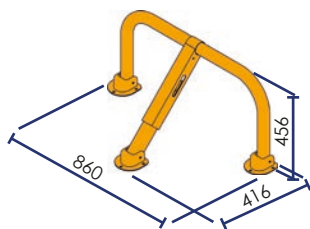
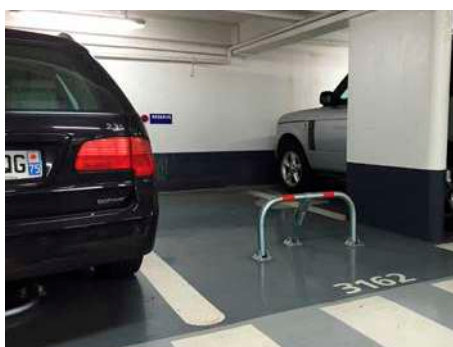

STOPRO



Code	Key icon
STOPROJA	
STOPROJAPASS *	
STOPRO 50JA	
STOPRO 100JA	
STOPRO 114JA	

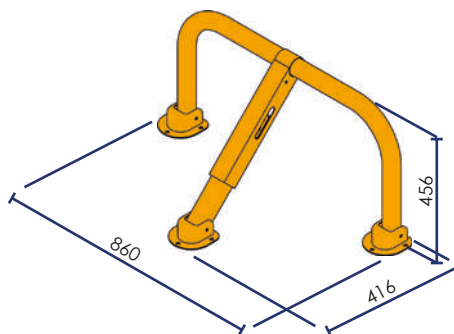

Tous les arceaux d'une commande ont la même serrure
 All the parking hoop of an order have same lock
 Todas las barreras de un pedido tienen la misma cerradura
 Alle Parkbügel einer Bestellung haben das gleiche Schloss

INCLUS
 INCLUDED ◦ INCLUIDO ◦ INKLUSIVE



Ø 10 x 80
 x 9

STOPRO - STOPWHEEL

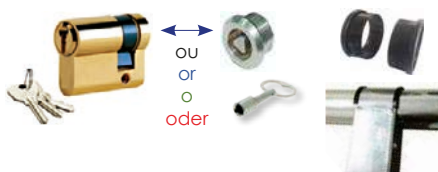

ou
 or
 o
 oder

OPTION ◦ OPTIONAL
 OPCIÓN ◦ OPTIONAL



TPU FIX 1 SB
 Ø 12 x 80

* **MASTERKEY**





Pour ouvrir avec clé passe partout :
 minimum de commande : 5.
 To open with a master key : MOQ = 5 pcs.
 Para abrir con llave maestra :
 pedido mínimo : 5.
 Zum Öffnen mit einem Hauptschlüssel:
 Mindestbestellmenge : 5.









STOPFRAME / STOPBLOCK



STOPBLOCK

STOPBLOCK GALVA      Fonte d'acier galvanisé à chaud / Hot-dip galvanized cast iron / Hierro fundido galvanizado / Feuerverzinkter Stahlguss

Code	
STOPBLOCK	
STOPBLOCKPASS *	 
STOPBLOCK 50	
STOPBLOCK 100	 11
STOPBLOCK 114	 14

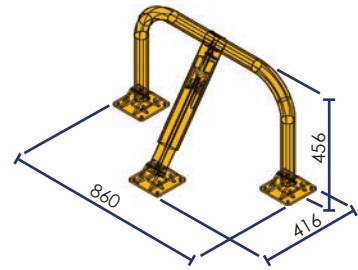

 Tous les arceaux d'une commande ont la même serrure
All the parking hoop of an order have same lock
Todas las barreras de un pedido tienen la misma cerradura
Alle Parkbügel einer Bestellung haben das gleiche Schloss

INCLUS / INCLUDED / INCLUIDO / INKLUSIVE

Ø 10 x 80 x 12

ou / or / oder

OPTION / OPTIONAL / OPCIÓN / OPTIONAL





TPU FIX 1 SB
Ø 12 x 80

 **MASTERKEY**
Pour ouvrir avec clé passe partout : minimum de commande : 5.
To open with a master key : MOQ = 5 pcs.
Para abrir con llave maestra : pedido mínimo : 5.
Zum Öffnen mit einem Hauptschlüssel : Mindestbestellmenge: 5.

STOPFRAME  **CAOUTCHOUC VULCANISÉ** / VULCANIZED RUBBER / CAUCHO VULCANIZADO / VULKANISIERTEM KAUTSCHUK

STRUCTURE AUTOPORTANTE ▶ STOPBLOCK

PARKING HOOP FRAME
BASE EMPOTRABLE
SELBSTUNTERSTÜTZENDE STRUKTUR

Code	 
STOPFRAME	1200 x 900 x H 85

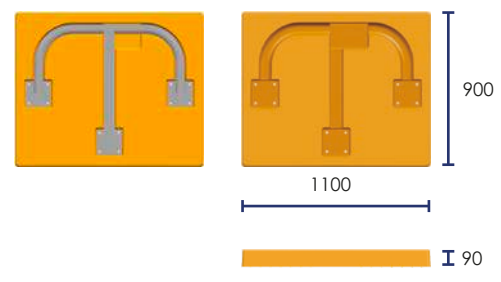

INCLUS / INCLUDED / INCLUIDO / INKLUSIVE



12 écrous + boulons pour fixation STOPBLOCK
12 bolts and nuts for STOPBLOCK fixation
12 tuercas + tornillos para fijación STOPBLOCK
12 Muttern + Schrauben zur STOPBLOCK-Befestigung





STOPCRASH

STOPUSH

STOPCRASH



Fonte d'acier galvanisé à chaud
Hot-dip galvanized cast iron
Hierro fundido galvanizado
Feuerverzinkter Stahlguss

HAUTE RÉSIDENCE À RESSORTS ◦ HEAVY DUTY WITH SPRINGS
ALTA RESISTENCIA CON RESORTES ◦ HOHER WIDERSTAND DURCH FEDER

Code	Key
STOPCRASH	
STOPCRASHPASS *	
STOPCRASH 50	
STOPCRASH 100	11
STOPCRASH 114	14

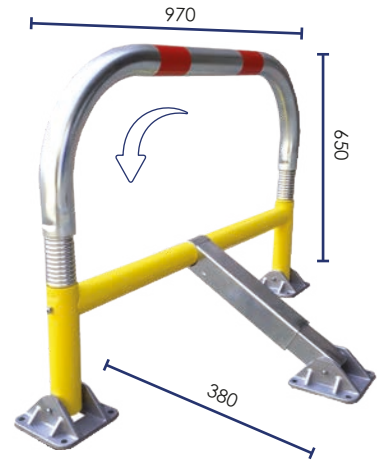

STOPUSH

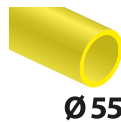
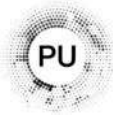

Fonte d'acier galvanisé à chaud
Hot-dip galvanized cast iron
Hierro fundido galvanizado
Feuerverzinkter Stahlguss

MÉMOIRE DE FORME ◦ FLEXIBLE PARKING HOOP
BARRERA FLEXIBLE ◦ FORMGEDÄCHTNIS

Code	Key
STOPUSH	
STOPUSHPASS *	
STOPUSH 50	
STOPUSH 100	11
STOPUSH 114	14

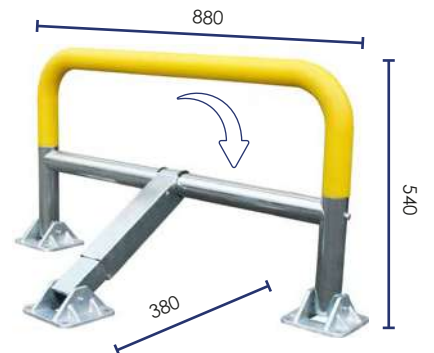

► STOPCRASH / STOPUSH

INCLUS
INCLUDED ◦ INCLUIDO ◦ INKLUSIVE

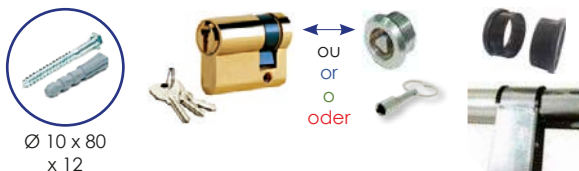

► STOPCRASH / STOPUSH

OPTION ◦ OPTIONAL
OPCIÓN ◦ OPTIONAL



* **MASTERKEY**
Pour ouvrir avec clé passe partout :
minimum de commande : 5.
To open with a master key : MOQ = 5 pcs.
Para abrir con llave maestra :
pedido mínimo : 5.
Zum Öffnen mit einem Hauptschlüssel:
Mindestbestellmenge: 5.

Tous les arceaux d'une commande ont la même serrure
All the parking hoop of an order have same lock
Todas las barreras de un pedido tienen la misma cerradura
Alle Parkbügel einer Bestellung haben das gleiche Schloss



LOCAR / LOCAM



STOPSOL

STOPSOL



ZINGUÉ
ZINC
ZINCADO
VERZINKTEM



+ 40 °C
- 5 °C

ARCEAU DE PARKING AUTOMATIQUE ◦ SOLAR PARKING HOOP ARCO PARA PARKING ABATIBLE AUTOMÁTICO ◦ SOLAR PARKBÜGEL

Code		
STOPSOL	2	600 X 400



Ø 8 x 70
x 3

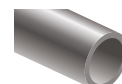

Ø 38



- Batterie lithium : IP 94 V0 - 6 V / 12 AH. Dimensions : 150 x 93 x 50, temps de chargement 2 h.
- Vitesse ouverture / fermeture : 5 s / 6 s.
- Utilisation sans soleil : environ 2 mois pour une utilisation 4 fois par jour.
- Télécommande : détectée dans un rayon de 15 m. Les télécommandes d'un STOPSOL n'ouvrent pas les autres.
- Important : Une sirène s'active en cas de choc sur l'arceau.
- Possibilité de commander une télécommande supplémentaire (réf. : STOPSOLTEL).

- Battery : IP 94 V0 - 6 V / 12 AH. Size : 150 x 93 x 50, charging time : 2 hours.
- Opening / closing speed : 5 s / 6 s.
- Use without sun : about 2 months using it 4 times a day.
- Remote detected at around 15 m. Remote can open only the assigned STOPSOL.
- Important : a siren is activated in case of shock with the barrier.
- Additional remote control available (ref : STOPSOLTEL).

- Bateria : IP 94 V0 - 6 V / 12 AH. Dimensiones : 150 x 93 x 50, tiempo de carga 2 h.
- Velocidad : apertura / cierre : 5 s / 6 s.
- Uso sin sol : unos 2 meses con un uso de 4 veces al día.
- Control remoto : Detectado en un área de 15 m. Los mandos a distancia de un STOPSOL no abren los demás.
- Importante : se activa una sirena en caso de impacto en el arco.
- Mando a distancia adicional disponible (ref: STOPSOLTEL).

- AKKU : SPF 94 V0 - 6 V / 12 AH. Abmessungen : 150 x 93 x 50, ladezeit 2 h.
- Geschwindigkeit öffnen / schließen : 5 s / 6 s.
- Verwendung ohne Sonne : Ca. 2 Monate für eine Anwendung 4-mal täglich.
- Fernbedienung : in einem umkreis von 15 m erkennen. Die fernbedienungen eines STOPSOL öffnen die anderen nicht.
- Wichtig : alarm wird beim aufprall auf den bügel aktiviert.
- Möglichkeit, eine zusätzliche Fernbedienung zu bestellen (Ref.: STOPSOLTEL).

SABOT ANTI-VOL

WHEEL BLOCKING SYSTEM ◦ CEPO ANTIRROBO ◦ RADKRALLE



Code			
LOCAR	≤ 11,5"	800 x 300 x 240	8
LOCAM	12 ≤ ≤ 20"	900 x 390 x 280	10





WHEELTRUCK

WHEELSTOP

CALE ROUE POUR VOITURE ET POIDS LOURDS ◦ **CAR AND TRUCK WHEEL CHOCK**
CALZO PARA RUEDA DE COCHE Y CAMION ◦ **RADSTOPP FÜR PKW UND LKW**

Code				
CARSTOP	X		195 x 100 x 150	2,10
WHEELSTOP		X	340 x 200 x 190	8
WHEELTRUCK		X	387 x 168 x 177	1,35
WHEELPARK	X	X	500 x 150 x 100	6,50

CARSTOP

CAOUTCHOUC VULCANISÉ
VULCANIZED RUBBER
CAUCHO VULCANIZADO
VULKANISIERTEM KAUSCHUK

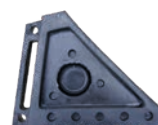

WHEELPARK

CAOUTCHOUC VULCANISÉ
VULCANIZED RUBBER
CAUCHO VULCANIZADO
VULKANISIERTEM KAUSCHUK



WHEELTRUCK

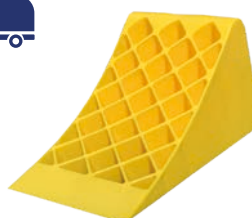

WHEELSTOP

CAOUTCHOUC VULCANISÉ
VULCANIZED RUBBER
CAUCHO VULCANIZADO
VULKANISIERTEM KAUSCHUK



NORME
 ECE R27

TRIANG

TRIANGLE DE SIGNALISATION ◦ **WARNING TRIANGLE**
TRIÁNGULO DE SEÑALIZACIÓN ◦ **WARNDREIECK**

Code		
TRIANG	440 x 380 x 440 (440 x 140 x 30)	0,62





RAMPE DE PORTAIL ◦ GATE RAMP
RAMPA DE ENTRADA ◦ EINFahrtschwelle vor einem Tor

CAOUTCHOUC
 RUBBER
 CAUCHO
 KAUSCHUK

Code	
WARN 1200	5

OPTION ◦ OPTIONAL
 OPCIÓN ◦ OPTIONAL

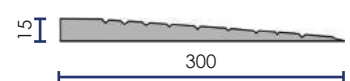
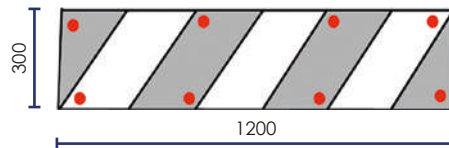

SIGNALISATION DE VIRAGE / PARKING
PARKING RAMP SIGN ◦ SEÑAL PARA APARCAMIENTO ◦ SIGNALISIERUNG

CAOUTCHOUC
 RUBBER
 CAUCHO
 KAUSCHUK

Code	
WALL 1200	4,60

INCLUS ◦ INCLUDED
 INCLUIDO ◦ INKLUSIVE

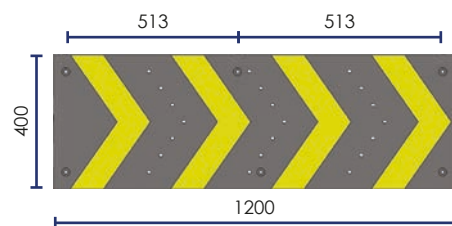
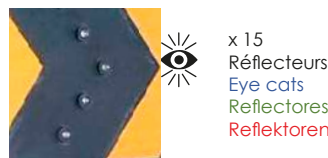
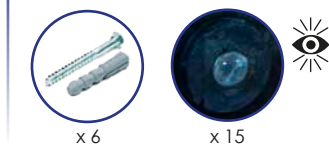

ADHÉSIF / MARQUAGE AU SOL EXTÉRIEUR
FLOOR STICKERS ◦ STICKERS PARA SUELO ◦ BODENSTICKER

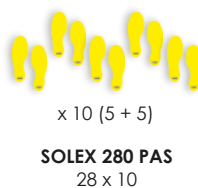



MR / MD



MH

MIROIR D'AGGLOMÉRATION ◦ **AGGLOMERATION MIRROR**
ESPEJO DE AGLOMERACIÓN ◦ **VERKEHRSSPIEGEL**



MH

France : conforme à l'arrêté du 21/09/1981 relatif à la signalisation routière

Code	m		kg
MH 69	10		4,6
MH 129	15	130°	7,0
MH 99	12		6,5

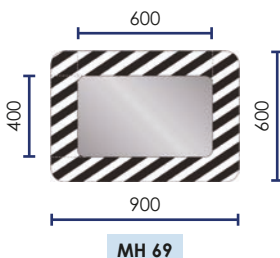

MH 69

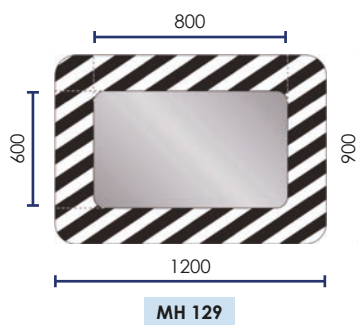

MH 129

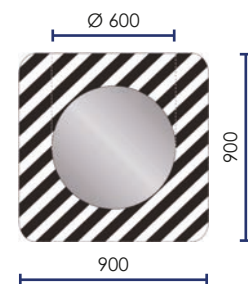

MH 99

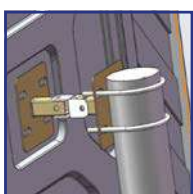

Avec fixation Ø 60 mm
 With fixation
 Con fijaciones
 Mit Befestigung

MR / MD

Code	m		kg
MD 45 RB	7		2,3
MD 60 RB	12		2,6
MD 80 RB	20	130°	4,5
MR 3054 RB	10		2,5
MR 5684 RB	20		6,2



Réfléchissant
 Reflective
 Reflectivo
 Reflektierend
CLASSE 2



MR 3054 RB



MR 5684 RB

Avec fixation Ø 60 mm selon modèle (A / B)
 With fixation depending on model (A / B)
 Con fijaciones según referencia (A / B)
 Mit Befestigung nach Modell (A / B)

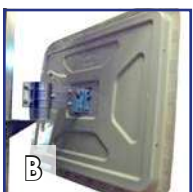
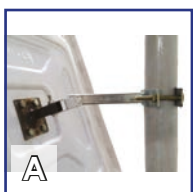

MD 45 RB



MD 60 RB



MD 80 RB



MIROIR

M 450 / 600 / 800

MIROIR DE SÉCURITÉ

MIRRORS ◦ ESPEJO ◦ SICHERHEITSSPIEGEL

Code		
	m	130°
MIROIR	5	130°



Tige flexible 30 cm
Flexible stem
Varilla flexible
Flexibler Stab

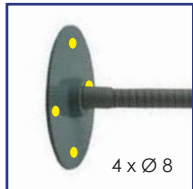

MIROIR



Code		
	m	130°
M 450	10	
M 600	15	130°
M 800	25	



Avec fixation Ø 60 mm selon modèle (A / B)
With fixation depending on model (A / B)
Con fijaciones según referencia (A / B)
Mit Befestigung nach Modell (A / B)

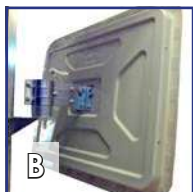
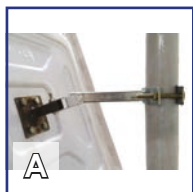

Code		
	m	130°
M 4161	10	
M 5177	20	130°



M 5177

Avec fixation Ø 60 mm selon modèle (A / B)
With fixation depending on model (A / B)
Con fijaciones según referencia (A / B)
Mit Befestigung nach Modell (A / B)

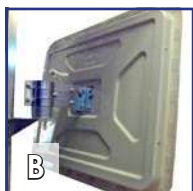
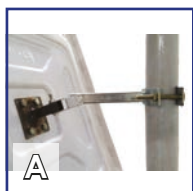



VELOTRACK



VELO 1

RACK À VÉLO

BICYCLE RACK ◦ APARCA BICICLETA ◦ FAHRRADSTÄNDER

VELO 1

Sol / mur
Wall / floor
Piso / Pared
Boden / Wand



Extensible
Expandable
Extensible
Ausziehbar



ZINGUÉ
ZINC
CINCADO
VERZINKTEM

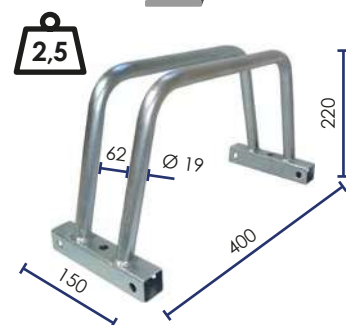

INCLUS ◦ INCLUDED ◦ INCLUIDO ◦ INKLUSIVE



VELOTRACK

OPTION
OPTIONAL
OPCIÓN
OPTIONAL



FSAFE 2 SB
Ø 12 x 120

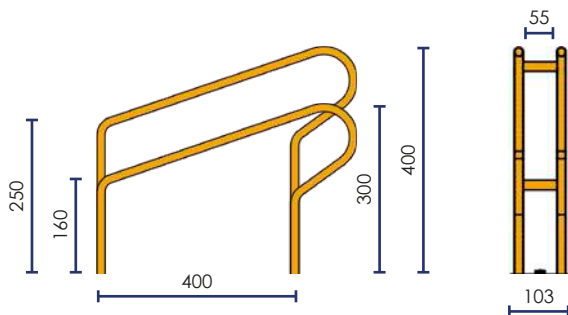

GALVA

VELOTRACK P

0,9

1,1

VELOTRACK G

VELOSTORE

Code	
VELOSTORE	3

6



RAI 7037

PEINTURE ÉPOXY
POWDER PAINTING
PINTURA EPOXICA
EPOXY FARBE

INCLUS
INCLUDED ◦ INCLUIDO ◦ INKLUSIVE

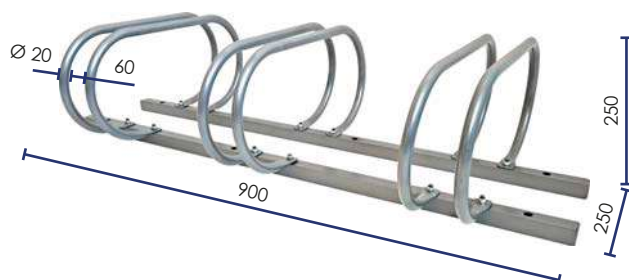



RACK À VÉLO ◦ **BICYCLE RACK** ◦ **APARCA BICICLETA** ◦ **FAHRRADSTÄNDER**

VELO 755 GAL

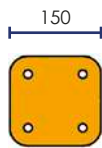
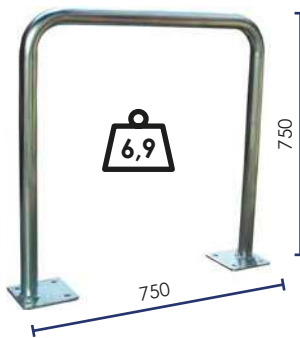
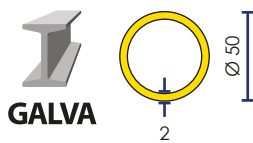

POT 162 V *

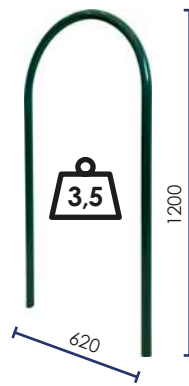
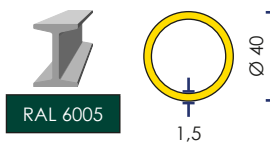

VELO 5



INCLUS
INCLUDED ◦ INCLUIDO ◦ INKLUSIVE

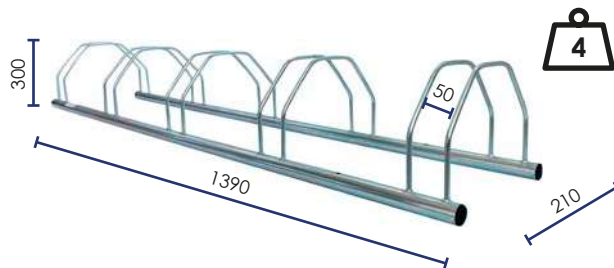

VELOSTAND

10 ≤  ≤ 14

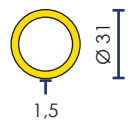
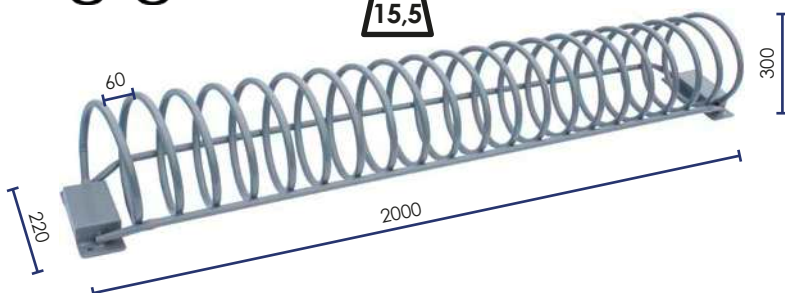

OPTION
OPTIONAL
OPCIÓN
OPTIONAL



FSAFE 4 SB
Ø 12 x 120



Ne pas installer en milieu salin ou Hydrocarbure. Nous consulter.
Do not install in saline or Oil environment. Contact us.
No lo instale en un ambiente salino o hidrocarburo. Consúltenos.
Soll nicht in Salz oder Kohlenstoff Umgebung installiert werden, /Uns Konsultieren.

Sauf ◦ Except ◦ Salvo ◦ Nur





VELORING



RACK À TROTINETTE ◦ **SCOOTER RACK**
APARCA PATINETES ◦ **PARKSTÄNDER FÜR SCOOTER**



RAL 9005



PEINTURE ÉPOXY
 POWDER PAINTING
 PINTURA EPOXICA
 EPOXY FARBE

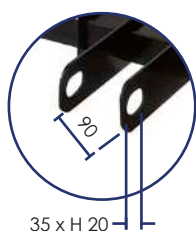
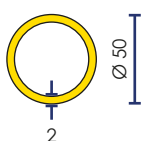

Bords arrondis
 Rounded edges
 Bordes redondeados
 Abgerundete Ecken

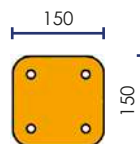
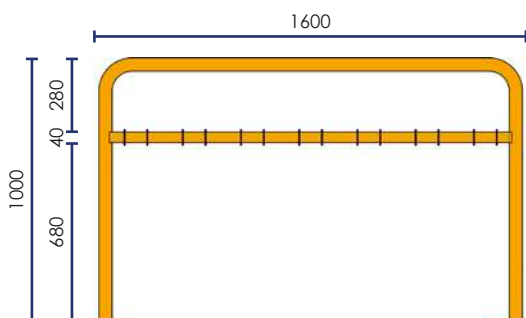

OPTION
 OPTIONAL
 OPCIÓN
 OPTIONAL



BARFIX 8 SB
 Ø 12 x 120

ÉPINGLE À VÉLO ◦ **U-SHAPED BIKE RACK**
HORQUILLA APARCA BICICLETA ◦ **FAHRRADSTÄNDER**



RAL 9005



PEINTURE ÉPOXY
 POWDER PAINTING
 PINTURA EPOXICA
 EPOXY FARBE

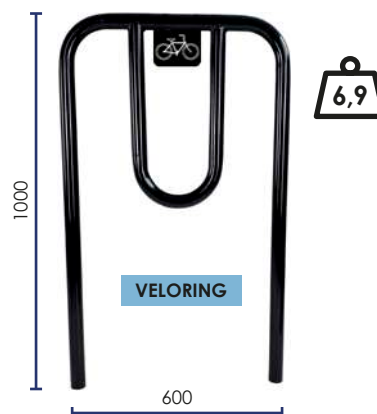
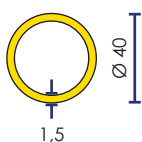

OPTION
 OPTIONAL ◦ OPCIÓN ◦ OPTIONAL



BAS SOL

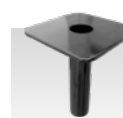

BBASE



Ne pas installer en milieu salin ou Hydrocarbure. Nous consulter.
 Do not install in saline or Oil environment. Contact us.
 No lo instale en un ambiente salino o hidrocarburo. Consúltanos.
 Soll nicht in Salz oder Kohlenstoff Umgebung installiert werden, /uns Konsultieren.

Sauf ◦ Except ◦ Salvo ◦ Nur



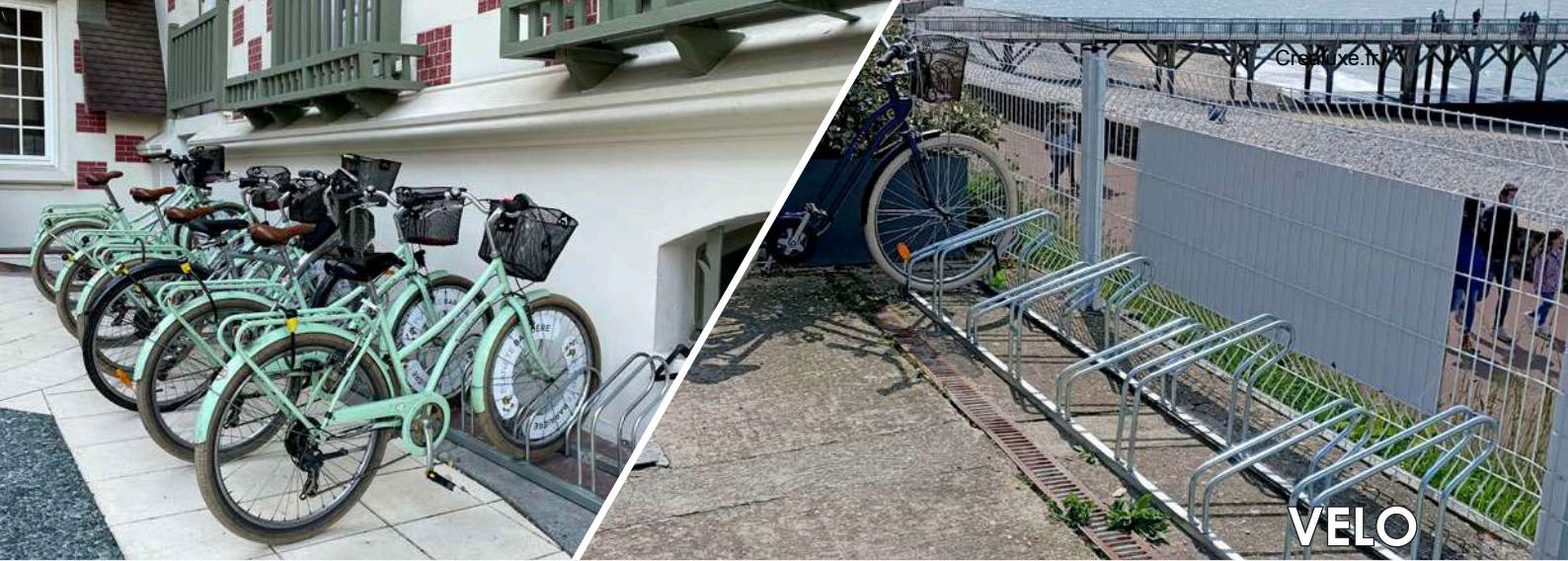

VELO

RACK À VÉLO ○ BICYCLE RACK PARKING BICICLETA ○ FAHRRADSTÄNDER



OPTION
OPCIONAL
OPCIÓN
OPTIONAL

FSAFE 4 SB
Ø 12 x 120

- VELO 42 / 52 peuvent recevoir des vélos des 2 côtés.
- Fixations non incluses (4 x Ø 12 mm).

- VELO 42 / 52 can receive bicycles on both sides.
- Fixations are not included (4 x Ø 12 mm).





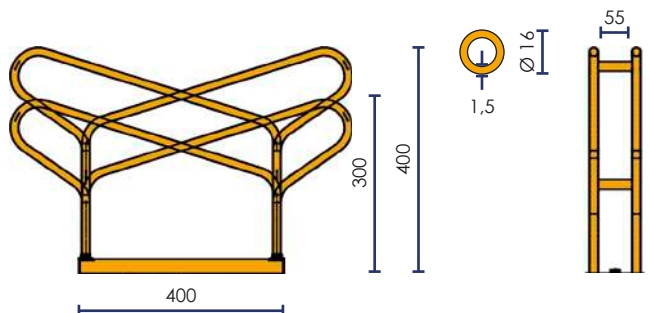
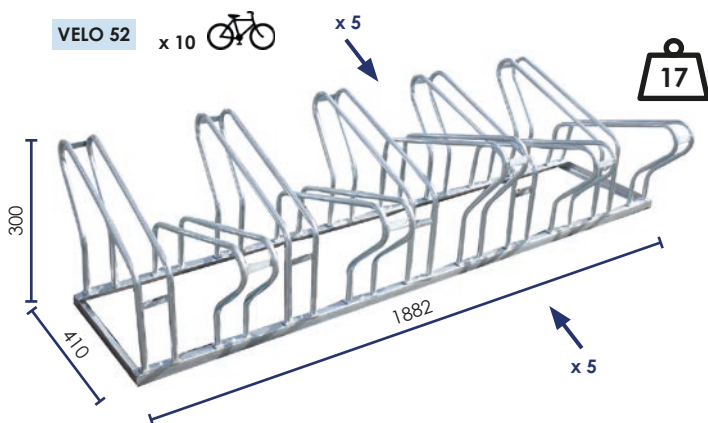
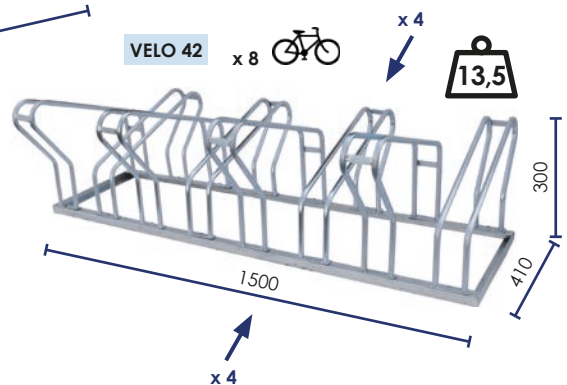
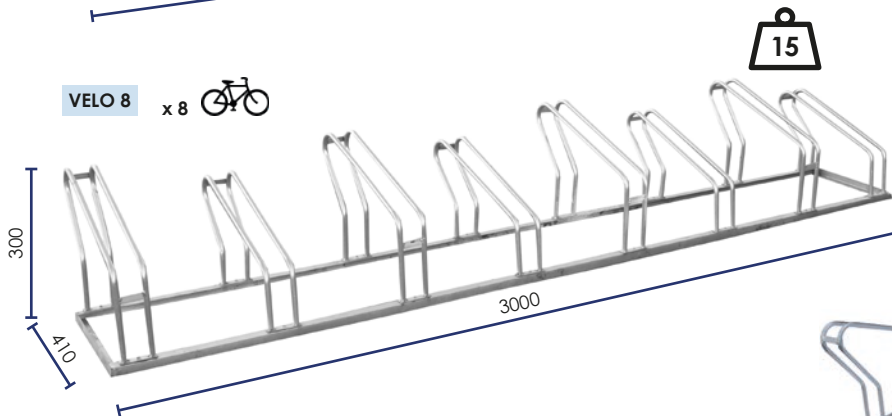
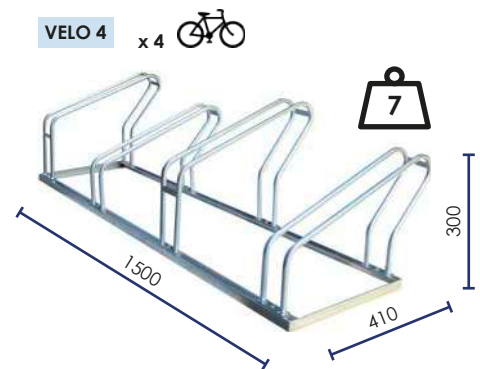
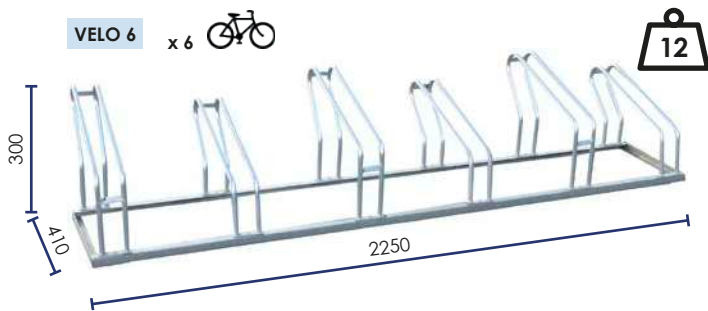

- VELO 42 / 52 pueden sostener bicicletas en ambos lados.
- Fijaciones no incluidas (4 x Ø 12 mm).

- VELO 42 / 52 kann von beiden Seiten Fahrräder aufnehmen.
- Ohne Bindungen (4 x Ø 12 mm).













**FIXATION
UNIVERSELLE**
UNIVERSAL FIXING
FIJACIÓN UNIVERSAL
BEFESTIGUNGSMITTEL
UNIVERSAL

	Code			
	FIX 1 SB	x 1	Ø 12 x 130	0,07
	FIX 4 SB	x 4		0,12
	FIX 34 SB	x 34		2,80
	FIX 164 SB	x 4	Ø 12 x 160	0,35
	TPU FIX 1 SB	x 1	Ø 12 x 80	0,07
	BAR FIX 1 SB	x 1	Ø 12 x 80	0,07
	BAR FIX 8 SB	x 8		0,07
	BAR FIX 304 SB	x 4	Ø 12 x 100	0,35

FIXATION BÉTON
CONCRETE FIXING
FIJACIÓN HORMIGÓN
BEFESTIGUNGSMITTEL
BETON

	Code				
	FIX SAFE	x 1	Ø 12 x 120	0,15	
	FSAFE 2 SB	x 2		0,32	
	FSAFE 4 SB	x 4		0,64	
	FSAFE 12 SB	x 12		1,94	
	FIX 253 SB	x 3	Ø 16 x 250	2,80	► BUT 1200
	RR FIX 4 SB	x 4	2 x Ø 6 x 60 2 x Ø 10 x 100	0,20	► RR 35 / 100 / 150 / 200
	FIX WP 244 SB	x 4	Ø 10 x 100	0,40	► WP 240
	CP 5 FIX SB	x 4	Ø 6 x 60	0,20	► CP 5040



**FIXATION
ASPHALTE**
ASPHALT FIXING
FIJACIÓN ASFALTO
BEFESTIGUNGSMITTEL
ASPHALT

	Code				
	SPIKES	x 1	Ø 12 x 300	0,25	
	SPIKE 2 SB	x 2		0,50	
	SPIKE 4 SB	x 4		1,00	
	SPIKE 253 SB	x 3	Ø 14 x 350	0,95	► BUT 1200
	SPIKE WP 244 SB	x 4	Ø 10 x 300	0,80	► WP 240
	CP5 SPIKE SB	x 4	Ø 6 x 300	0,60	► CP 5040
	RR SPIKE 4 SB	x 4	2 x Ø 6 x 60 2 x Ø 10 x 100	0,60	► RR 35 / 100 / 150 / 200

H DE LIAISON
H LINK
H DE UNIÓN
H BEFESTIGUNGSMITTEL

	Code				
	GEY 1 SB	x 1	80 x 45	0,25	
	GEY 2 SB	x 2		0,50	
	GEY 14 SB	x 14		1,00	
	SPEED H 4 SB	x 4		0,95	► EASYSPEED / FAST 60 / SAFETY
	SAFETY 25 H 4 SB	x 4	50 x 30	0,80	► SAFETY 25
	EASYFAST 4 H SB	x 4		0,60	► EASYFAST

COLLE
GLUE
PEGAMENTO
KLEBEMITTEL

	Code		
	RQ GLUE	Colle polymère 290 ml Polymer glue 290 ml Pegamento polímero 290 ml Polymerkleber 290 ml	0,50
	POD GLUE	Colle époxyuréthane bicomposant Two-component epoxy adhesive Adhesivo epoxi de dos componentes Zweikomponenten-Epoxyd-Urethan-Klebstoff	5,00
	POD GLUE 2		2,00
	PODSEAL	Scellement chimique 300 ml Chemical sealant 300 ml Sellador químico 300ml Chemische Versiegelung 300 ml	

Créa Luxe . fr

Crealuxe SARL
BP 4003584101 Orange
CEDEX
04 86 71 54 42
serviceclient@crealuxe.fr

