

## Catalogue Sign

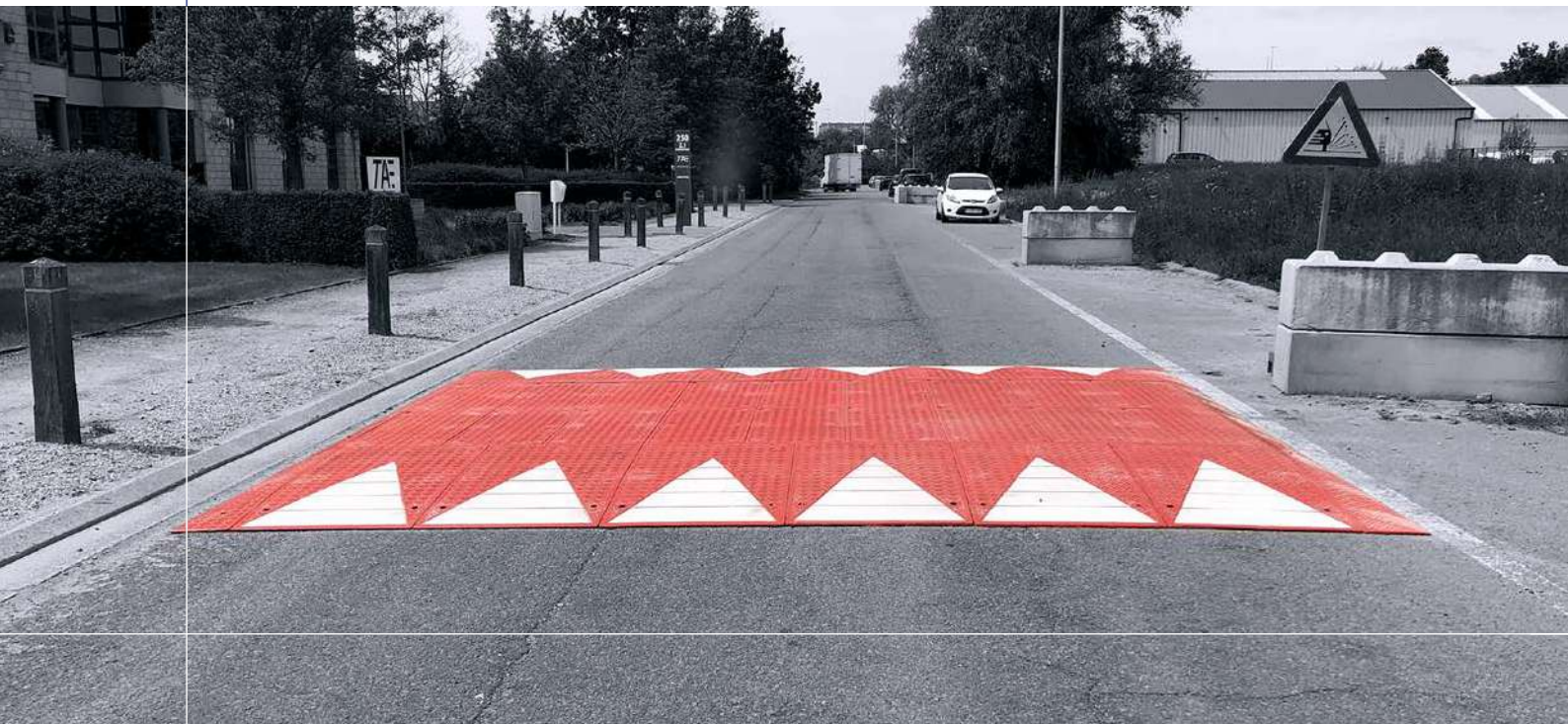





## Voirie ◦ Road equipment

## RALENTISSEURS ◦ SPEED BUMPS

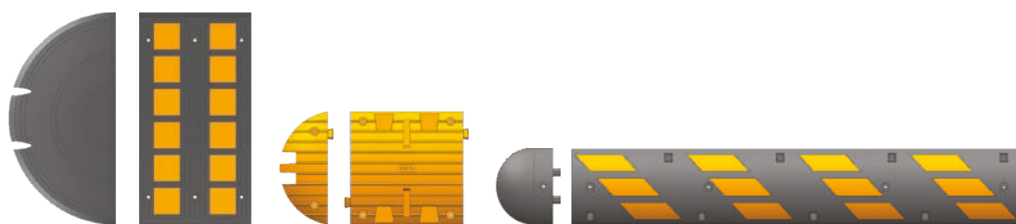

## RAMPE ◦ RAMPS

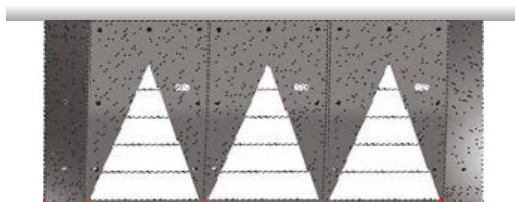
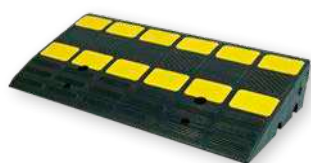

## POTEAUX À MÉMOIRE DE FORME ◦ FLEXIBLE BOLLARDS

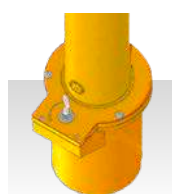

## ÉQUIPEMENTS DE PARKING ◦ PARKING EQUIPMENT

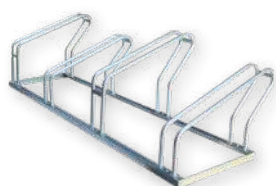

## BARRIÈRES ◦ BARRIERS







# DODANE

VOIE PUBLIQUE

## DOS D'ÂNE

SPEED TABLE ◦ LOMO DE ASNO ◦ AUFPLASTERUNG



CAOUTCHOUC VULCANISÉ  
VULCANIZED RUBBER  
CAUCHO VULCANIZADO  
VULKANISIERTEM KAUSCHUK

OPTION  
OPTIONAL  
OPCIÓN  
OPTIONAL



Code	m		Surface m <sup>2</sup> Surface Superficie Oberfläche
	L	P	
DODANE 4040	4,00	4,00	16
DODANE 4750	4,75	4,00	19
DODANE 5540	5,50	4,00	22
DODANE 6240	6,25	4,00	25
DODANE 7040	7,00	4,00	28
DODANE 7740	7,75	4,00	31
DODANE 8540	8,50	4,00	34
DODANE 9254	9,25	4,00	37

Option  
Optional ◦ Opción ◦ Optional  
LED jour / nuit  
night / day ◦ día / noche ◦ tag / nacht

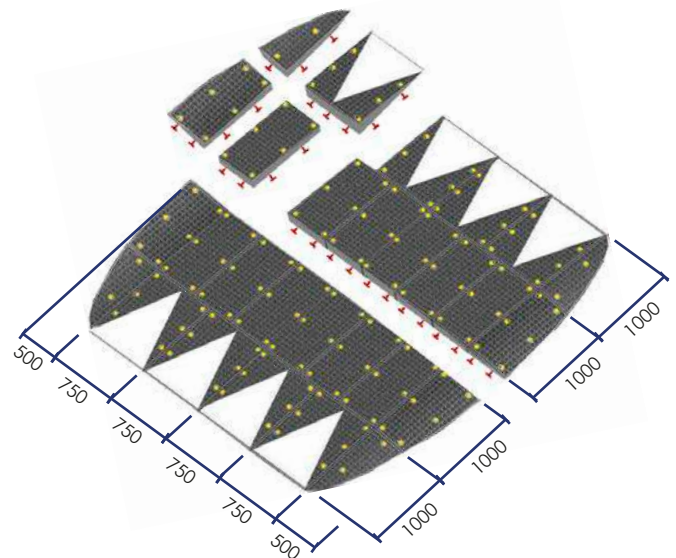
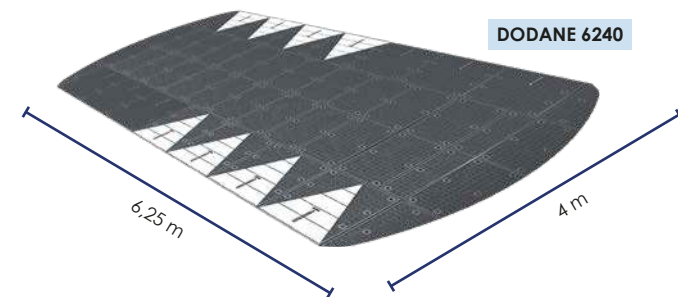
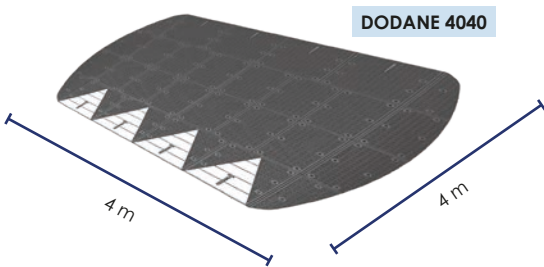
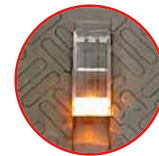

INCLUS ◦ INCLUDED ◦ INCLUIDO ◦ INKLUSIVE



OPTION ◦ OPTIONAL ◦ OPCIÓN ◦ OPTIONAL

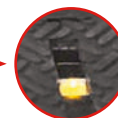





VOIE PUBLIQUE

CO - KOB

# COUSSIN BERLINOIS

SPEED CUSHION ◦ COJÍN BERLINÉS ◦ BERLINER KISSEN



CAOUTCHOUC VULCANISÉ  
VULCANIZED RUBBER  
CAUCHO VULCANIZADO  
VULKANISIERTEM KAUSCHUK

OPTION  
OPTIONAL  
OPCIÓN  
OPCIÓN



CO 3 R



CO 2 BR



CO 2 N



CO 3 NB



CO 3 BG



CO 3 BR





CO - KOB

VOIE PUBLIQUE

## COUSSIN BERLINOIS

SPEED CUSHION ◦ COJÍN BERLINÉS ◦ BERLINER KISSEN

0 65 mm



CAOUTCHOUC VULCANISÉ  
VULCANIZED RUBBER  
CAUCHO VULCANIZADO  
VULKANISIERTEM KAUTSCHUK

OPTION  
OPTIONAL  
OPCIÓN  
OPTIONAL



2 M  
2,25 M

Code			mm			kg
KOB 6 N KOB 6 R	 	6	2250 x 1800 x 65	28	14	268
CO 2 N CO 2 R CO 2 BG CO 2 BR	   	4	2000 x 1800 x 65	24	8	240

• Sur commande ◦ Under request ◦ Bajo pedido ◦ Auf Bestellung

CO 2 NB CO 2 NJ	 	4	2000 x 1800 x 65	24	8	240
--------------------	------	---	------------------	----	---	-----

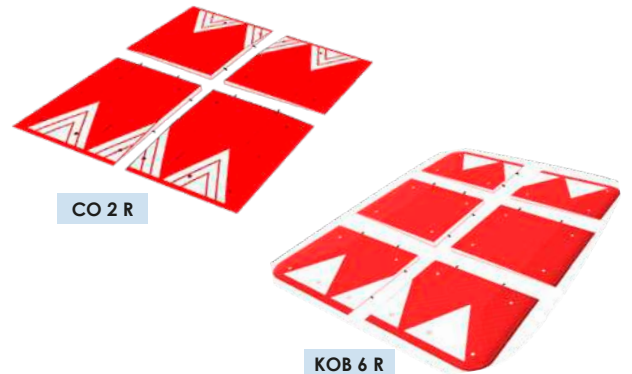

3 M

Code			mm			kg
KOB 8 N KOB 8 R	 	8	3000 x 1800 x 65	36	20	368
CO 3 N CO 3 R CO 3 BG CO 3 BR	   	6	3000 x 1800 x 65	34	14	360

• Sur commande ◦ Under request ◦ Bajo pedido ◦ Auf Bestellung

CO 3 NB CO 3 NJ	 	6	3000 x 1800 x 65	34	14	360
--------------------	------	---	------------------	----	----	-----



INCLUS ◦ INCLUDED ◦ INCLUIDO ◦ INKLUSIVE

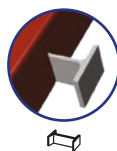

OPTION ◦ OPTIONAL ◦ OPCIÓN ◦ OPTIONAL

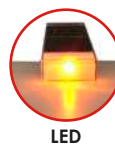

CO2 ▶ 3 x RQ GLUE  
CO3 / KOB6 ▶ 4 x RQ GLUE  
KOB8 ▶ 6 x RQ GLUE





VOIE PUBLIQUE

ZEBRA 65

**PLATEAU**

SPEED TABLE ◦ REDUCTOR DE VELOCIDAD ◦ PLATEAU-KISSEN



CAOUTCHOUC VULCANISÉ  
VULCANIZED RUBBER  
CAUCHO VULCANIZADO  
VULKANISIERTEM KAUSCHUK

OPTION  
OPTIONAL  
OPCIÓN  
OPTIONAL

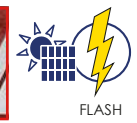

Code	
ZEBRA 65 BK	
ZEBRA 65 RO	

ZEBRA 65 BK / 5630

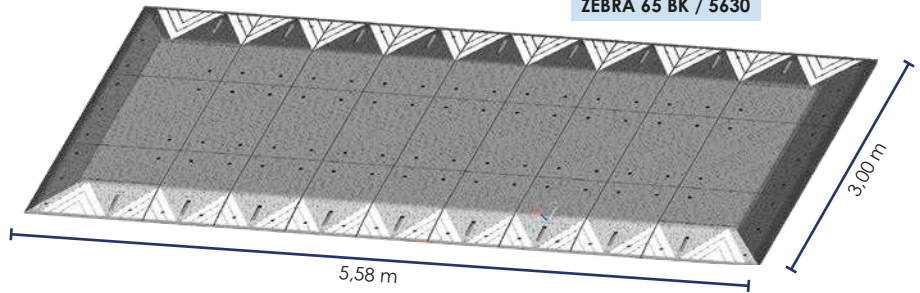

ZEBRA 65 RO / 3040

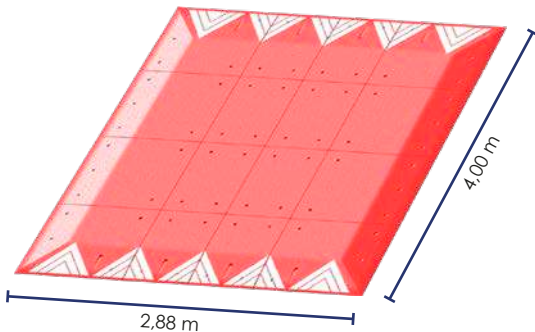

**DIMENSIONS MODULABLES**  
MODULAR DIMENSIONS  
DIMENSIONES MODULARES  
VARIABLE ABMESSUNGEN

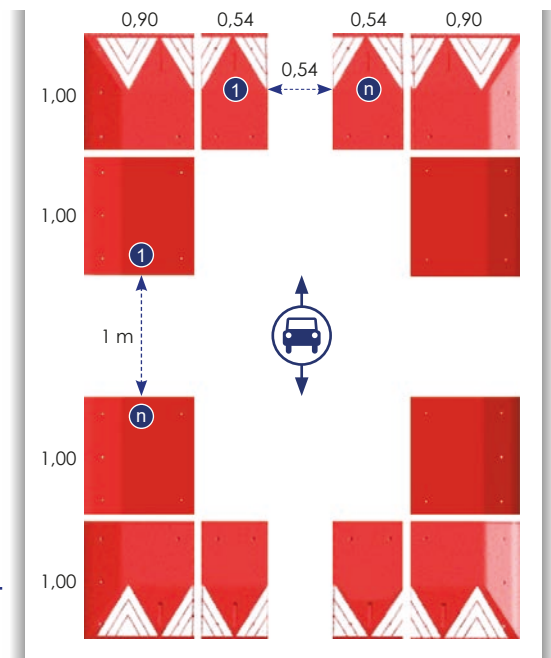

INCLUS ◦ INCLUDED ◦ INCLUIDO ◦ INKLUSIVE



OPTION ◦ OPTIONAL ◦ OPCIÓN ◦ OPTIONAL

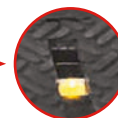





ZEBRA 100 BEL

ZEBRA 100

PLATEAU ◦ SPEED TABLE

RESALTO DE SECCIÓN TRANSVERSAL TRAPEZOIDAL ◦ PLATEAU-KISSEN

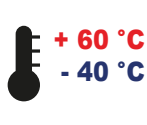

CAOUTCHOUC VULCANISÉ  
VULCANIZED RUBBER  
CAUCHO VULCANIZADO  
VULKANISIERTEM KAUSCHUK

OPTION  
OPTIONAL  
OPCIÓN  
OPTIONAL



Code	
ZEBRA 100 BK	●
ZEBRA 100 RO	●
ZEBRA 100 BKBEL	●
ZEBRA 100 ROBEL	●

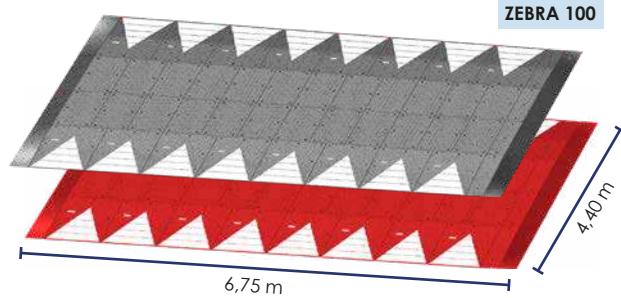

ZEBRA 100

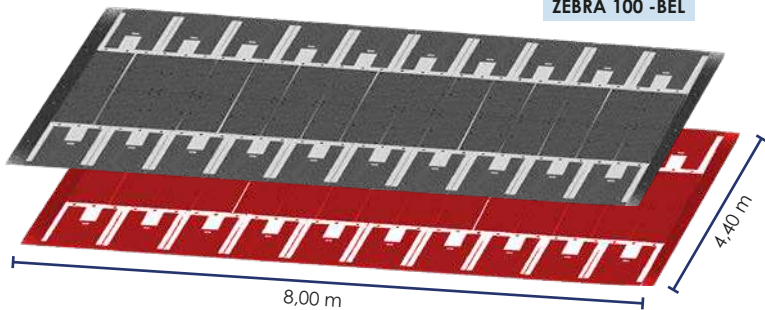
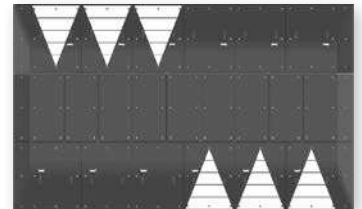

ZEBRA 100 -BEL

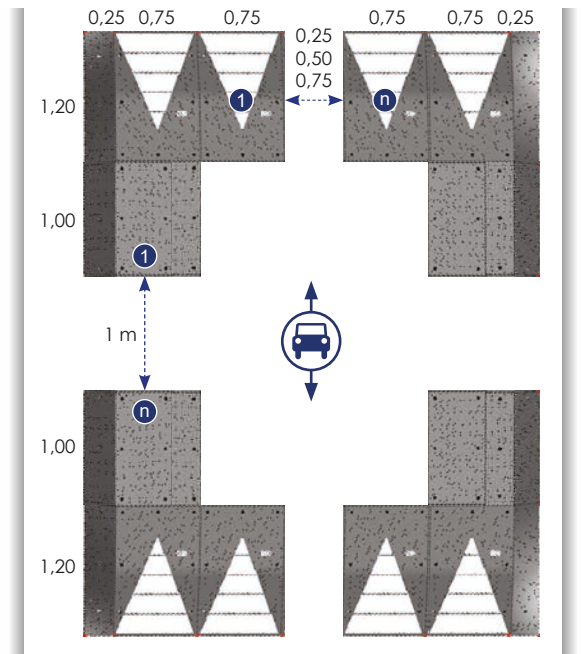

**DIMENSIONS MODULABLES**  
MODULAR DIMENSIONS  
DIMENSIONES MODULARES  
VARIABLE ABMESSUNGEN

INCLUS ◦ INCLUDED ◦ INCLUIDO ◦ INKLUSIVE



200 m



Ø 12 x 130



OPTION ◦ OPTIONAL ◦ OPCIÓN ◦ OPTIONAL

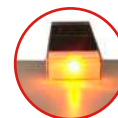

LED

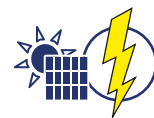
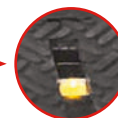

FLASH





**PASSAGE PIÉTONS**

ZEBRA CROSSING ◦ PASO PEATONAL SOBREELEVADO ◦ ZEBRA STREIFEN



CAOUTCHOUC VULCANISÉ  
VULCANIZED RUBBER  
CAUCHO VULCANIZADO  
VULKANISIERTEM KAUSCHUK

OPTION  
OPTIONAL  
OPCIÓN  
OPTIONAL

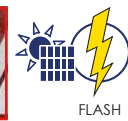

Code	
ZEBRA 100 PAPBK	
ZEBRA 100 PAPRO	
ZEBRA 100 BEMPAPBK	
ZEBRA 100 BEMPAPRO	

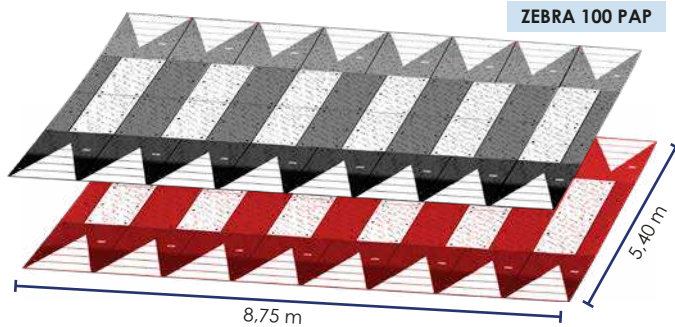

**DIMENSIONS MODULABLES**  
MODULAR DIMENSIONS  
DIMENSIONES MODULARES  
VARIABLE ABMESSUNGEN

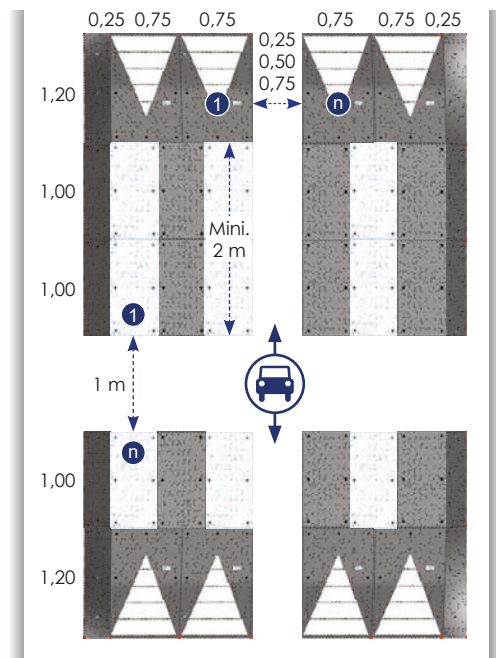
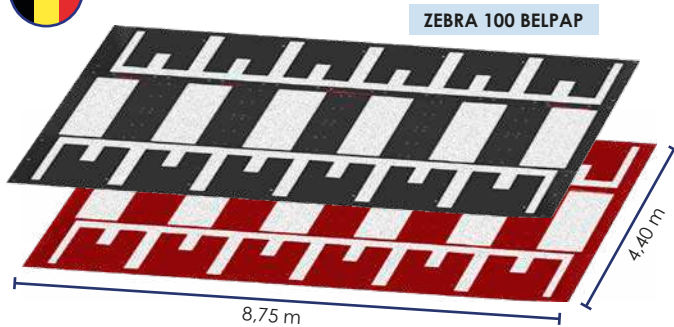

INCLUS ◦ INCLUDED ◦ INCLUIDO ◦ INKLUSIVE

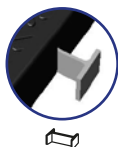

OPTION ◦ OPTIONAL ◦ OPCIÓN ◦ OPTIONAL

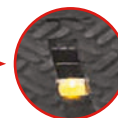





VOIE PUBLIQUE

# RALENTISSEUR

SPEED RAMP ◦ REDUCTOR DE VELOCIDAD ◦ FAHRBAHNSCHWELLEN



CAOUTCHOUC VULCANISÉ  
VULCANIZED RUBBER  
CAUCHO VULCANIZADO  
VULKANISIERTEM KAUTSCHUK

OPTION  
OPTIONAL  
OPCIÓN  
OPTIONAL



Code	Largeur de route m Road width Ancho de carretera Breite	Surface m <sup>2</sup> Surface Superficie Oberfläche	kg
ZE 300	3,00	7,20	509
ZE 325	3,25	7,80	567
ZE 350	3,50	8,40	576
ZE 375	3,75	9,00	634
ZE 400	4,00	9,60	692
ZE 425	4,25	10,20	701
ZE 450	4,50	10,80	759
ZE 475	4,75	11,40	817
ZE 500	5,00	12,00	826

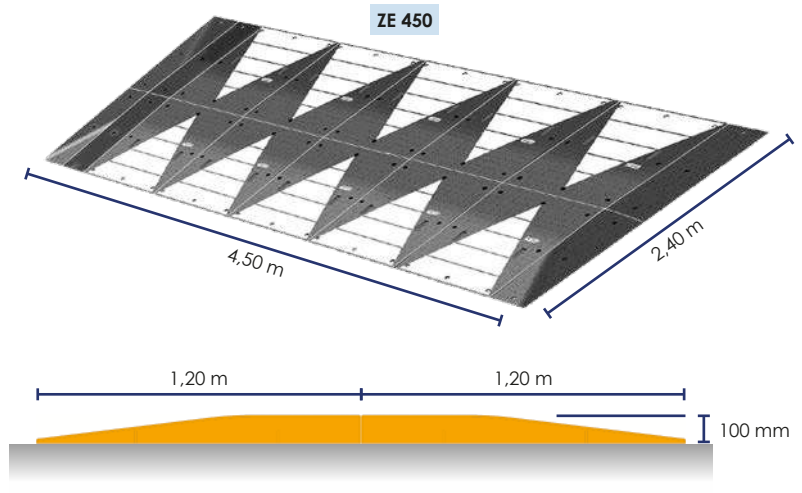

Couleur à préciser à la commande ◦ Color to be specified when ordering  
Color a confirmar al realizar el pedido ◦ Farbe bei Bestellung anzugeben



INCLUS ◦ INCLUDED ◦ INCLUIDO ◦ INKLUSIVE



200 m



Ø 12 x 130



OPTION ◦ OPTIONAL ◦ OPCIÓN ◦ OPTIONAL

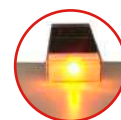

LED

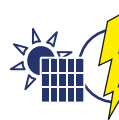
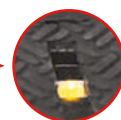

FLASH





RR

ZE

# RAMPES

RAMPS ◦ RAMPAS ◦ BORDSTEIN-RAMPEN



+ 60 °C  
- 40 °C



CAOUTCHOUC VULCANISÉ  
VULCANIZED RUBBER  
CAUCHO VULCANIZADO  
VULKANISIERTEM KAUSCHUK



## RR

Code	H	I	kg	Icon
RR 35	35	300	6,50	4
RR 100	100	300	12,00	4
RR 150	150	360	19,00	4
RR 200	200	450	32,00	4
RRD 35	35	300	2,00	2
RRD 100	100	300	4,00	2
RRD 150	150	360	8,00	2
RRD 200	200	450	17,00	2

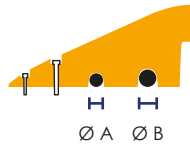

Code	Ø A	Ø B
RR / RRD 35	-	10
RR / RRD 100	25	30
RR / RRD 150	30	35
RR / RRD 200	35	40

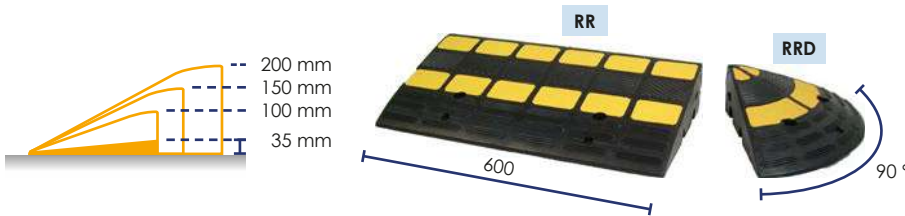
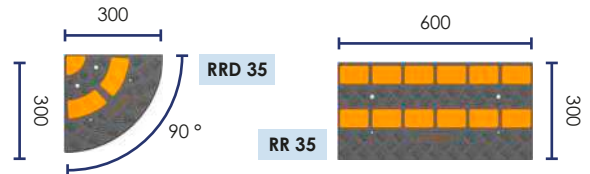

OPTION ◦ OPTIONAL ◦ OPCIÓN ◦ OPTIONAL



RR FIX 4 SB  
2 x Ø 6  
2 x Ø 10



RR SPIKE 4 SB  
2 x (Ø 6 x 300)  
2 x (Ø 10 x 300)



RQ GLUE

## ZE

Code	Icon 1	Icon 2	kg
ZE 100 RAMP	6	7	55
ZE 100 END	3	5	23
ZE 25 G	3	3	17
ZE 25 D	3	3	17

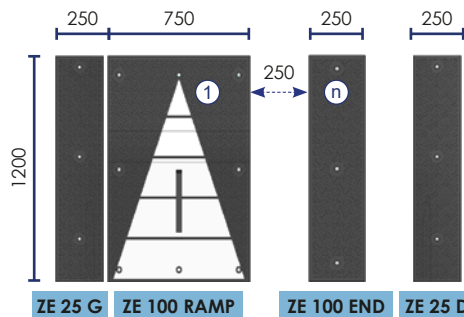

INCLUS ◦ INCLUDED ◦ INCLUIDO ◦ INKLUSIVE



FIX 1 SB  
Ø 12 x 130

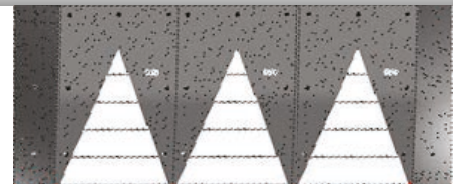

ZE 25 G ZE 100 RAMP

ZE 25 D





SEP



+ 60 °C  
- 40 °C



CAOUTCHOUC VULCANISÉ  
VULCANIZED RUBBER  
CAUCHO VULCANIZADO  
VULKANISIERTEM KAUSCHUK

0 100 mm

## ROND-POINT

ROUND ABOUT ◦ ROTONDA ◦ KREISVERKEHR

Code			
ILO 300	40	24	513

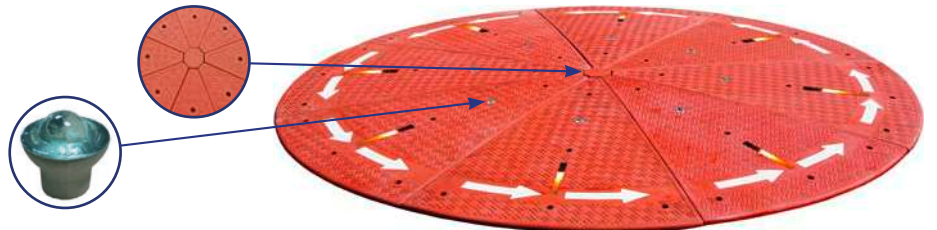

INCLUS ◦ INCLUDED ◦ INCLUIDO ◦ INKLUSIVE



EN 1463-2

OPTION ◦ OPTIONAL ◦ OPCIÓN ◦ OPTIONAL



## SÉPARATEUR DE VOIE FRANCHISSABLE

TRAFFIC DIVIDER ◦ SEPARADOR DE VÍAS ◦ TRENNBALKEN

Code			
SEP 70 NB	●	2	3,80
SEP 70 RB	●	2	3,80
SEP 120 NB	●	3	8,50
SEP 120 RB	●	3	8,50

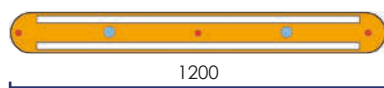
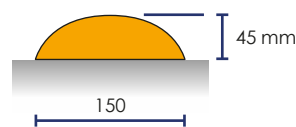
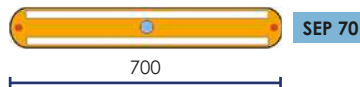

INCLUS ◦ INCLUDED  
INCLUIDO ◦ INKLUSIVE



OPTION ◦ OPTIONAL ◦ OPCIÓN ◦ OPTIONAL







ILO 4025

ILO

**PLOT RALENTISSEUR**  
**CIRCULAR SPEED BUMP**  
**REDUCTOR DE VELOCIDAD CIRCULAR**  
**RUNDE BODENSCHWELLEN**

+ 60 °C  
 - 40 °C

CAOUTCHOUC VULCANISÉ  
 VULCANIZED RUBBER  
 CAUCHO VULCANIZADO  
 VULKANISIERTEM KAUSCHUK

Code		
ILO 4025		1
ILO 4025 VE		

2,2



ILO 4025 VE



ILO 4025

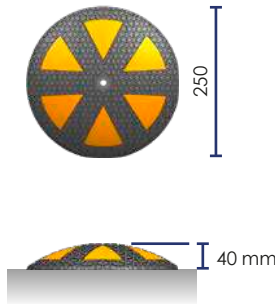

Code		
ILO 5035	x 2	8
ILO 6050	x 2	8
ILO 7040	x 2	8

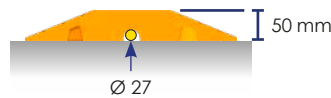

ILO 5035

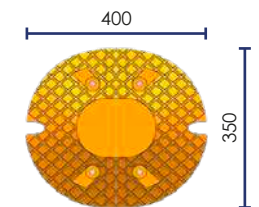
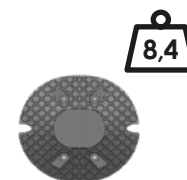

Combinaisons possibles ◦ Possible combinations  
 Combinaciones posibles ◦ Mögliche Kombinationen



ou  
 or  
 ◦  
 oder

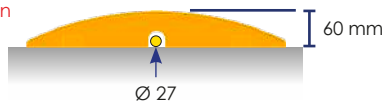

ILO 6050

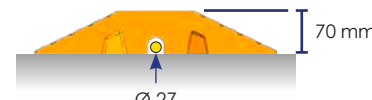
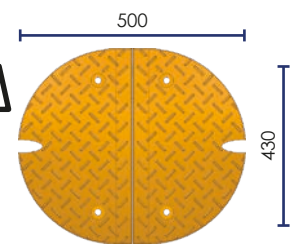
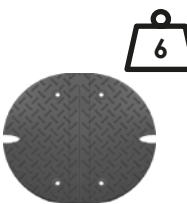

ILO 7040

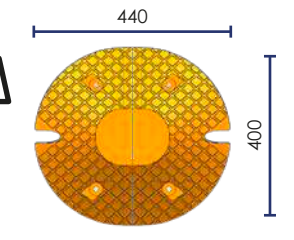
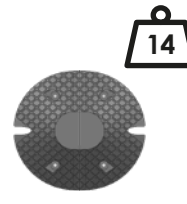

OPTION ◦ OPTIONAL  
 OPCIÓN ◦ OPTIONAL



SPIKES  
 Ø 12 x 300



FSAFE 4 SB  
 Ø 12 x 120



RQ GLUE

INCLUS ◦ INCLUDED  
 INCLUIDO ◦ INKLUSIVE



ILO 6050







TAH

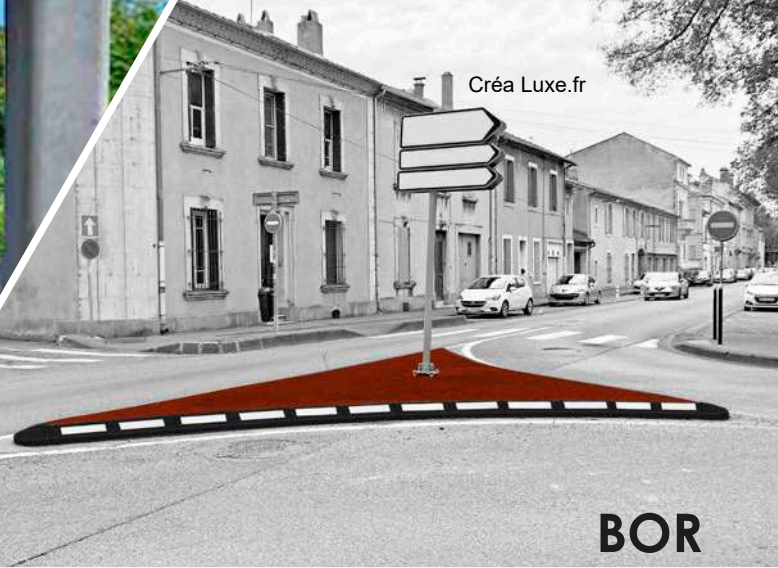

BOR

Créa Luxe.fr

**TAPIS ANTI HERBE** ◦ **GRASS PROTECTION PLATE**  
**PLACA ANTIHERBAS** ◦ **ANTI-UNKRAUT PLATTEN**



CAOUTCHOUC  
 RUBBER  
 CAUCHO  
 KAUSCHUK  
 ▶ TAH 1800

Code	Trou poteaux mm Post hole ◦ Agujero poste Pfofenloch	kg
TAH 500	80 x 80 ou ø 70 et ø 60	3,55
TAH 750	80 x 80 ou ø 70 et ø 60	7,60
TAH 1800	Ajustable 170 x 130	15,5

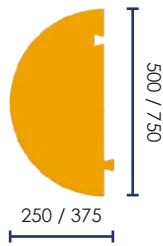

TAH 500 / 750

INCLUS ◦ INCLUDED  
 INCLUIDO ◦ INKLUSIVE

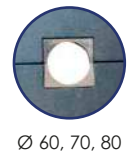

OPTION ◦ OPTIONAL  
 OPCIÓN ◦ OPTIONAL



SPIKES  
 Ø 12 x 300  
 TAH 1800

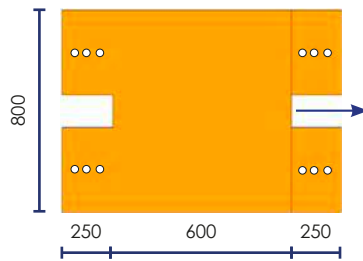

TAH 1800

**BORDURE DE DÉLIMITATION D'ÎLOT**  
**RUBBER BORDER** ◦ **BORDE DE GOMA** ◦ **BEGRENZUGSBALKEN**



Code	kg
BOR 1000 BK	6,65
BOR 250 BK	0,50

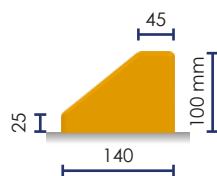

BOR 250 BK

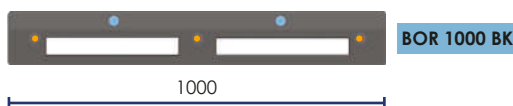

BOR 1000 BK



BOR 1000 BK

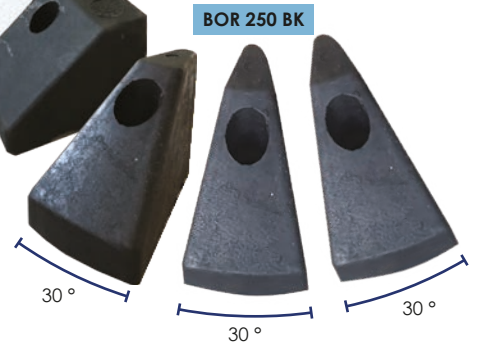

BOR 250 BK

INCLUS ◦ INCLUDED ◦ INCLUIDO ◦ INKLUSIVE



EN 1463-2 ▶ BOR1000BK

x 2

▶ BOR1000BK



SPIKES  
 Ø 12 x 300



FIXSAFE  
 Ø 12 x 120

OPTION ◦ OPTIONAL ◦ OPCIÓN ◦ OPTIONAL









SPEED

FAST 60

**RALENTISSEUR** ◦ **SPEED BUMP** ◦ **REDUCTOR DE VELOCIDAD** ◦ **FAHRBAHNSCHWELLE**



SPEED 70



SPEED 50  
FAST 60



CAOUTCHOUC  
RUBBER  
CAUCHO  
KAUTSCHUK



OIL

**SPEED**

Code	H mm		
SPEED 50	50	4	9,4
SPEND 50	50	4	4,9
SPEED 70	70	4	13,8
SPEND 70	70	4	8,0

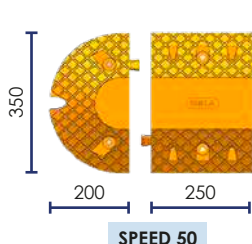

SPEED 50

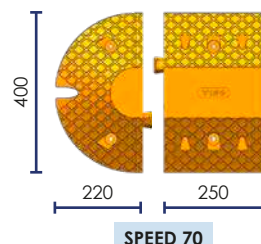

SPEED 70

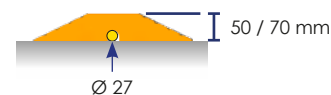

**INCLUS** ◦ **INCLUDED** ◦ **INCLUIDO** ◦ **INKLUSIVE**



x 2



Ø 27



**OPTION** ◦ **OPTIONAL** ◦ **OPCIÓN** ◦ **OPTIONAL**



SPIKES  
Ø 12 x 300



FSAFE 4 SB  
Ø 12 x 120



RQ GLUE

**FAST 60**

Code	H mm		
FAST 60 NJ	60	8	18,0
FASTEND 60	60	4	6,7

• Complet avec fixations ◦ Set with fixations  
Completo con fijaciones ◦ Komplettsset inkl. Befestigungen

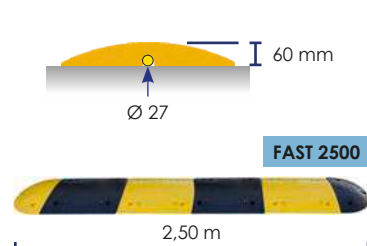
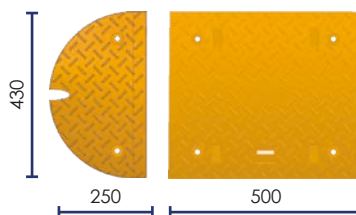

FAST 2500

Code	H mm	L	
FAST 2500	60	2,50 m	45,0
FAST 5000	60	5 m	83,0



FAST 5000



FAST 60 NJ

FAST END

**INCLUS** ◦ **INCLUDED** ◦ **INCLUIDO** ◦ **INKLUSIVE**

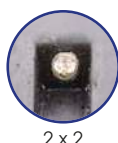

2 x 2



Ø 27



**OPTION** ◦ **OPTIONAL** ◦ **OPCIÓN** ◦ **OPTIONAL**



SPIKES  
Ø 12 x 300



FSAFE 4 SB  
Ø 12 x 120



RQ GLUE





FAST 70

FAST 50

**RALENTISSEUR** ◦ **SPEED BUMP** ◦ **REDUCTOR DE VELOCIDAD** ◦ **FAHRBAHNSCHWELLE**



FAST 70



FAST 50

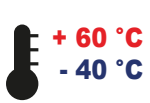

INCLUS  
INCLUDED  
INCLUIDO  
INKLUSIVE

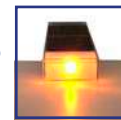

FASTLED

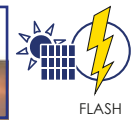

FLASH

Code	H mm		
FAST 50 NJ	50	8	14,0
FASTLED 50 NJ	50	8	14,0
FASTEND 50 NJ	50	4	6,4
FAST 70 NJ	70	8	23,0
FASTLED 70 NJ	70	8	23,0
FASTEND 70 NJ	70	4	8,0

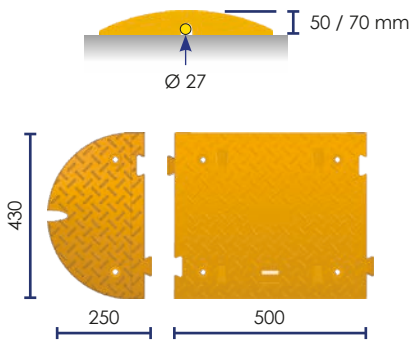

FAST 50 / 70 NJ



FASTEND 50 / 70 NJ

• Complet avec fixations ◦ Set with fixations  
Completo con fijaciones ◦ Komplettsset inkl. Befestigungen

Code	H mm	L	
FAST 5025	50	2,50 m	36
FAST 5050	50	5 m	73
FAST 7025	70	2,50 m	56
FAST 7050	70	5 m	111



FAST 5025



FAST 7050

• Complet avec LED et fixations ◦ Set LED with fixations  
Completo LED con fijaciones ◦ Komplettsset inkl. LED und Befestigungen

Code	H mm	L	
FASTLED 5025	50	2,50 m	36
FASTLED 5050	50	5 m	73
FASTLED 7025	70	2,50 m	56
FASTLED 7050	70	5 m	111



FLASH



FASTLED 5025



FASTLED 7050

INCLUS ◦ INCLUDED ◦ INCLUIDO ◦ INKLUSIVE

OPTION ◦ OPTIONAL ◦ OPCIÓN ◦ OPTIONAL



2 x 2



Ø 27



SPIKES  
Ø 12 x 300



FSAFE 4 SB  
Ø 12 x 120



RQ GLUE



FASTLED



# EASYFAST

# EASYSPEED

## RALENTISSEUR

SPEED RAMP ◦ REDUCTOR DE VELOCIDAD ◦ FAHRBAHNSCHWELLE



EASYFAST 75  
EASY SPEED 75

EASYFAST 55  
EASY SPEED 55

## EASYFAST

Code	H mm		kg
EASYFAST 55		2	6,2
EASYFAST 55 NB	55	2	6,2
ENDFAST 55		1	1,2
EASYFAST 75		2	8,5
EASYFAST 75 NB	75	2	8,5
ENDFAST 75		1	2,9

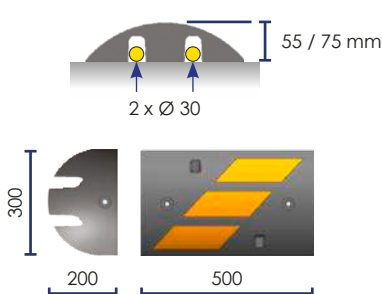

## EASYSPEED

Code	H mm		kg
EASYSPEED 55 NJ		4	28
END 55 N	55	1	3
EASYSPEED 55 CAP		6	34
EASYSPEED 75 NJ		4	45
END 75 N	75	1	5
EASYSPEED 75 CAP		6	55

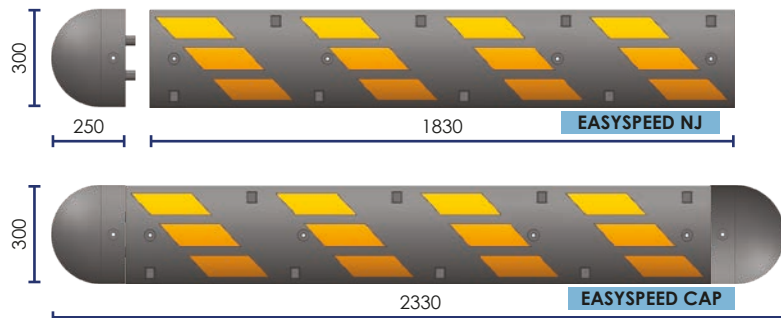

INCLUS ◦ INCLUDED ◦ INCLUIDO ◦ INKLUSIVE



SPIKE  
EASYSPEED

OPTION ◦ OPTIONAL ◦ OPCIÓN ◦ OPTIONAL



EASYFAST 4 H SB  
EASYFAST

SPEED H 4 SB  
EASYSPEED

SPIKES  
Ø 12 x 300

FSAFE 4 SB  
Ø 12 x 120

RQ GLUE





HD 700

**RALENTISSEUR POIDS LOURD** ◦ **HEAVY DUTY SPEED BUMP**  
**REDUCTOR DE VELOCIDAD PARA CAMIONES** ◦ **LKW-FAHRBAHNSCHWELLE**

Code	H mm		
HD 700 NJ	70	8	30,0
HDEND 700 NJ		4	7,5

• Eléments séparés ◦ Single element  
 Elementos separados ◦ Separate Elemente

HD 700 JA	70	4	14,8
HD 700 BK		4	14,8
HDEND 700 JA		2	3,7
HDEND 700 BK		2	3,7

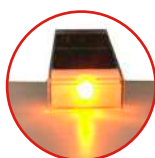
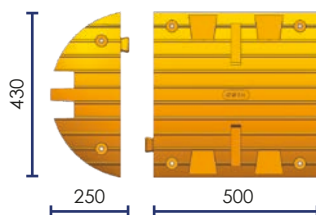
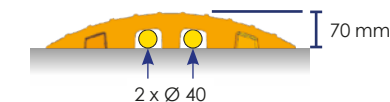

Option LED x 2



HD 700 NJ



HD END 700 NJ

• Complet avec fixations ◦ Set with fixations  
 Completo con fijaciones ◦ Komplettsset inkl. Befestigungen

Code	H mm	L	
HD 7025	70	2,50 m	70
HD 7050		5 m	144



2,50 m

HD 7025



5 m

HD 7050

INCLUS ◦ INCLUDED ◦ INCLUIDO ◦ INKLUSIVE



x 8

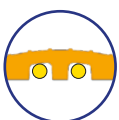

2 x Ø 40



OPTION ◦ OPTIONAL ◦ OPCIÓN ◦ OPTIONAL

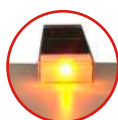

LED



SPIKE 4 SB  
 Ø 12 x 300



FSAFE 4 SB  
 Ø 12 x 120



RQ GLUE





SLOBUMP



EASYROLL

## RALENTISSEUR

SPEED RAMP ◦ REDUCTOR DE VELOCIDAD ◦ FAHRBAHNSCHWELLE

### SLOBUMP



Code		
SLOBUMP	4	29,50
SLOEND	1	2,27



INCLUS ◦ INCLUDED ◦ INCLUIDO ◦ INKLUSIVE

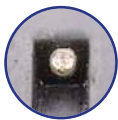

x 6



SPIKE 4 SB  
Ø 12 x 300

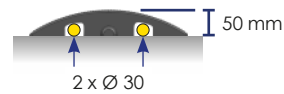

OPTIONAL  
OPCIÓN  
OPTIONAL



FSAFE 4 SB  
Ø 12 x 120

### EASYROLL - RALENTISSEUR TRANSPORTABLE

PORTABLE FOLDING SPEED BUMP ◦ REDUCTOR DE VELOCIDAD PLEGABLE  
TRANSPORTIERBARER FAHRBAHNSCHWELLE

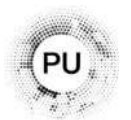

USAGE TEMPORAIRE ◦ TEMPORARY USE ◦ USO TEMPORARIO ◦ VORÜBERGEHENDE NUTZUNG

Code		
EASYROLL	360 x 250 x 355	12

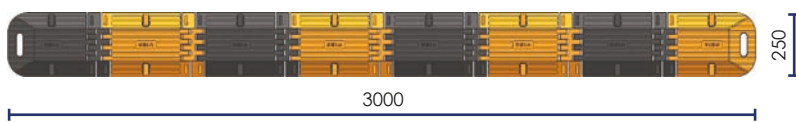

INCLUS ◦ INCLUDED ◦ INCLUIDO ◦ INKLUSIVE

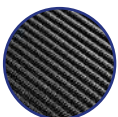

Antidérapant  
Non Skid : underneath  
Antideslizante  
Rutschfest







# COUSSIN DE RALENTISSEMENT

SPEED BUMP ◦ REDUCTOR DE VELOCIDAD ◦ FAHRBAHNSCHWELLE

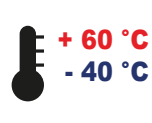

SAFETY 25

SAFETY 100

SAFETY 70

SAFETY 30  
SAFETY 50

Code	H mm			kg
SAFETY 25	20	6	-	7
SAFETY 30	30	6	2 x 15	10
SAFETY 50	50	6	2 x 25	19
SAFETY 70	70	6	2 x 35	27
SAFETY 100	100	4	2 x 50	27
SCUP 25	20	3	-	3,6
SCUP 30	30	3	2 x 15	4
SCUP 50	50	4	2 x 25	8
SCUP 70	70	4	2 x 35	18
SCUP 100	100	4	2 x 50	25

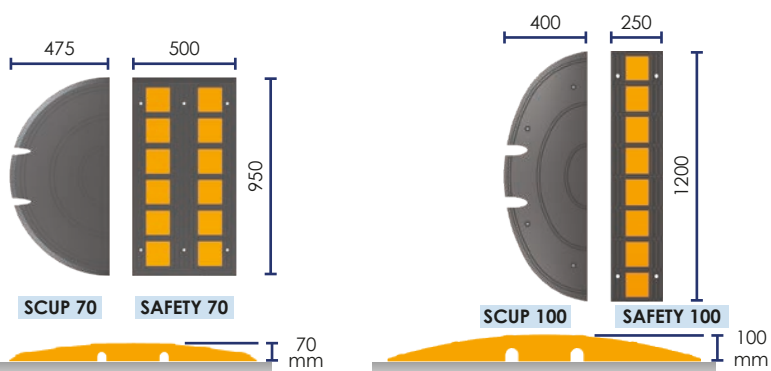
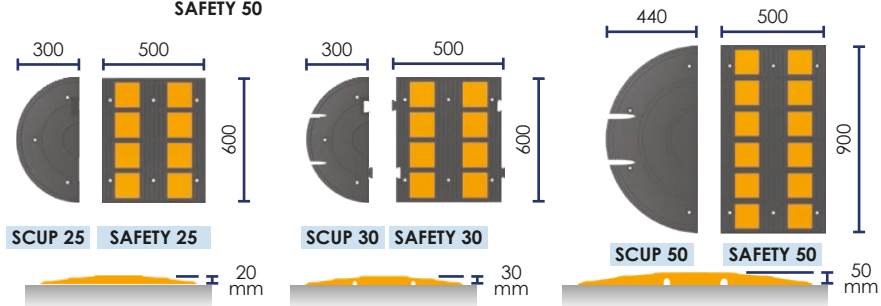

• Complet avec fixations ◦ Set with fixations  
Completo con fijaciones ◦ Kompletset inkl. Befestigungen

Code	L mm	I mm	H mm		kg
SAFETY 2525	2600	600	20	-	45
SAFETY 3025	2600	600	30	2 x 15	58
SAFETY 5025	2880	900	50	2 x 25	106
SAFETY 7025	2950	950	70	2 x 35	158
SAFETY 10025	2550	1200	100	2 x 50	715
SAFETY 2550	5100	600	20	-	82
SAFETY 3050	5100	600	30	2 x 15	118
SAFETY 5050	4880	900	50	2 x 25	192
SAFETY 7050	4950	950	70	2 x 35	177
SAFETY 10050	4800	1200	100	2 x 50	1450



SAFETY 3025



SAFETY 3050

INCLUS ◦ INCLUDED ◦ INCLUIDO ◦ INKLUSIVE

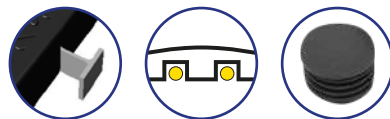

SAFETY 30 / 50 / 70 / 100

OPTION ◦ OPTIONAL ◦ OPCIÓN ◦ OPTIONAL







HERSE

EASYSTEEL

**RALENTISSEUR ACIER** ○ **STEEL SPEED BUMP**  
**REDUCTOR DE VELOCIDAD EN ACERO**  
**FAHRBAHNSCHWELLE AUS STAHL**



**EASYSTEEL**

Code		
EASYSTEEL 100 J	6	18,0
EASYSTEEL 25 J	4	5,0
EASYSTEEL END J	2 x 4	2 x 6,0

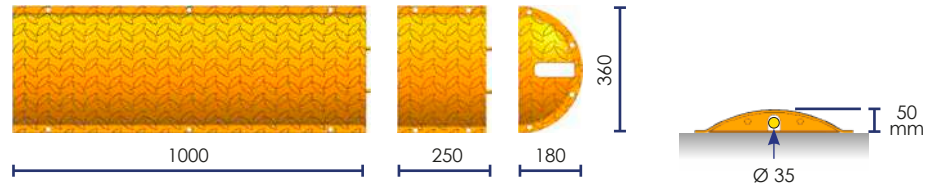

**INCLUS**  
**INCLUDED**  
**INCLUIDO**  
**INKLUSIVE**



Ø 35 mm

**OPTION**  
**OPTIONAL**  
**OPCIÓN**  
**OPTIONAL**



**FSAFE 4 SB**  
 Ø 12 x 120



EASYSTEEL 100 J



EASYSTEEL 25 J



EASYSTEEL END J

**HERSE**

Code		
HERSE 1000	6	28,5
HERSE END	2	2 x 4,0

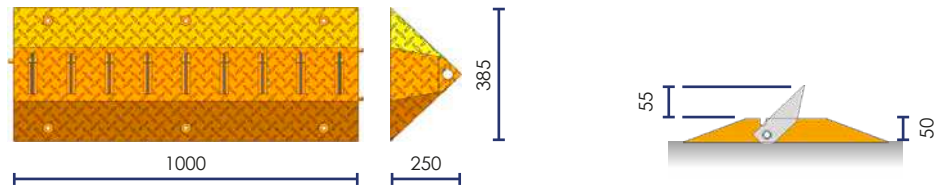

HERSE END



HERSE 1000



**INCLUS**  
**INCLUDED**  
**INCLUIDO**  
**INKLUSIVE**



**FIXSAFE**  
 Ø 12 x 120

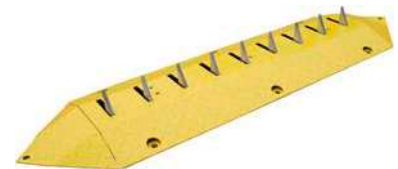





REF



POV

# RÉFLECTEUR LUMINEUX ET CLOU DE VOIRIE ◦ GLASS AND SOLAR ROAD STUD

BALIZAS REFLECTANTES / CAPTAFAROS ◦ BODENREFLEKTOREN UND MARKIERUNGSNAGEL

## REF

Code	∅ mm	kg
REF 501 SBS	50	0,20
REF 501 BASE		0,05
REF 100 SBS	100	0,56



REF 501 SBS

+



REF 501 BASE

=



REF 100 SBS

EN 1463-2



Code	mm	kg
REF 140 LED	∅ 140 x H 50	0,74



REF 140 LED

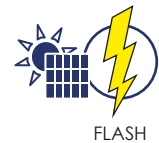

FLASH



## PSR



PSR 100 OR



PSR 100 VE

Code	Light	Color	kg
PSR 100 OR		Red	0,12
PSR 100 VE		Green	

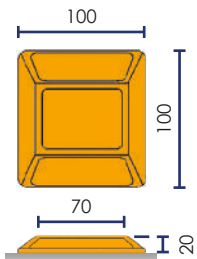

Option  
Optional  
Opción  
Optional



RQ GLUE



PSR 103 BU



PSR 103 OR



PSR 103 WH



PSR 103 VE



Code	Light	Color	kg
PSR 103 BU	3	Blue	0,30
PSR 103 BUFIX *	3	Blue	0,30
PSR 103 OR	3	Orange	0,30
PSR 103 ORFIX *	3	Orange	0,30
PSR 103 WH	3	White	0,30
PSR 103 WHFIX *	3	White	0,30
PSR 103 VE	3	Green	0,30
PSR 103 VEFIX *	3	Green	0,30



FLASH

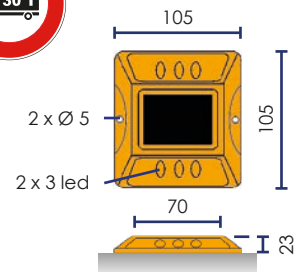

FLASH

## POV

Code	∅ mm	kg
POV 100	100	0,21
POV 150	150	0,25

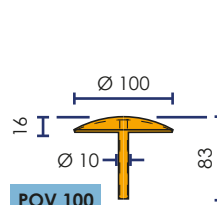

POV 100

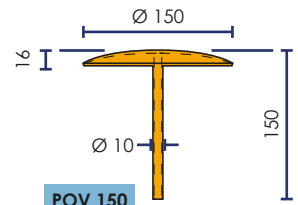

POV 150

OPTION ◦ OPTIONAL ◦ OPCIÓN ◦ OPZIONALE



PODSEAL

► p. 281









**TPA 660 / 810**

**BALISE FLEXIBLE** ◦ **FLEXIBLE BOLLARD**  
**BALIZA FLEXIBLE** ◦ **FLEXIBLE PFOSTEN**



Autres couleurs : mini 300  
 Otros colors : mini 300  
 Andere Farben : Mini 300

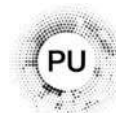

+ 50 °C  
 - 20 °C

Code	
TPA 660 BK	
TPA 810 BK	
TPA 660 OR	RAL 2017
TPA 810 OR	RAL 2017
TPA 660 VE	RAL 6024
TPA 810 VE	RAL 6024



Ø 80 mm

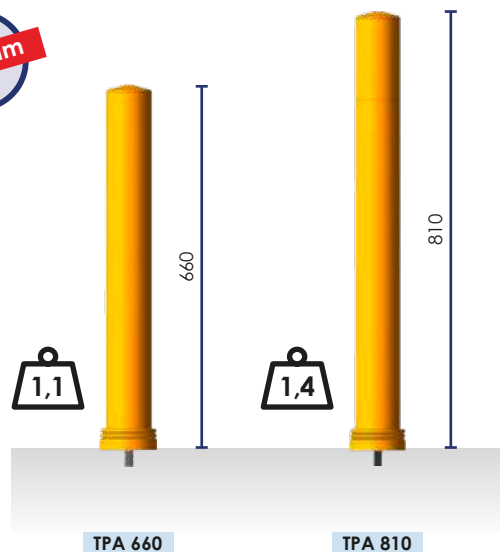

**INCLUS**  
 INCLUDED ◦ INCLUIDO ◦ INKLUSIVE



Ø 10

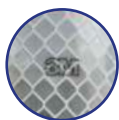





## POTELET FLEXIBLE À MÉMOIRE DE FORME

FLEXIBLE BOLLARD WITH SHAPE MEMORY

BOLARDO FLEXIBLE CON MEMORIA DE FORMA ◦ FLEXIBER PFOSTEN MIT FORMGEDÄCHTNIS



OPTION ◦ OPTIONAL ◦ OPCIÓN ◦ OPTIONAL

TP BOX 80 ▶ Ø 80  
TP BOX 100 ▶ Ø 100

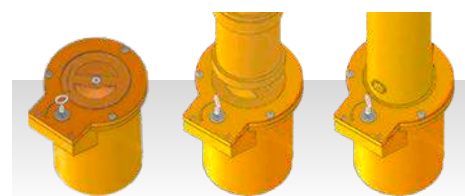
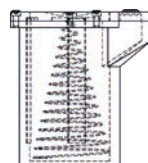
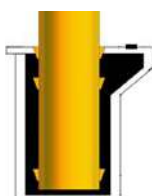

Caractéristiques techniques	Technical specifications	Características técnicas	Technische Daten	Résultat Result Resultado Ergebnis
Traitement anti UV	Anti UV treatment	Tratamiento anti UV	Anti-UV Behandlung	-
Dureté (Shore D)	Hardness (Shore D)	Dureza (Shore D)	Härte (Shore D)	46
Contrainte d'étirement constante à 100% (Mpa)	Tensile Stress at 100% Strain (MPa)	Limite elástico al 100% (MPa)	Beanspruchung bei konstanter Dehnung bis 100% (Mpa)	11.6
Résistance à la traction (MPa)	Tensile strength (Mpa)	Resistencia a la tracción (MPa)	Zugfestigkeit (Mpa)	33.9
Allongement à la rupture (%)	Elongation at break (%)	Elongación en la ruptura (%)	Bruchdehnung (%)	327
Résistance à la déchirure (KN/m)	Tear strength (KN/m)	Fuerza de desgarró (KN/m)	Reißfestigkeit (KN/m)	203



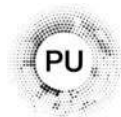

\* < -20 °C - Nous consulter  
Ask us ◦ Consultarnos  
Uns konsultieren

- RAL 9005
- RAL 6005
- RAL 7016
- RAL 8017

Autres couleurs : mini 5  
Others colors mini 5  
Otros colores : mini 5  
Andere Farben

1310 (A) (B) (C) (D) (E) (F) (G) (H) (I) (J) (K) (L) (M) (N) (O)

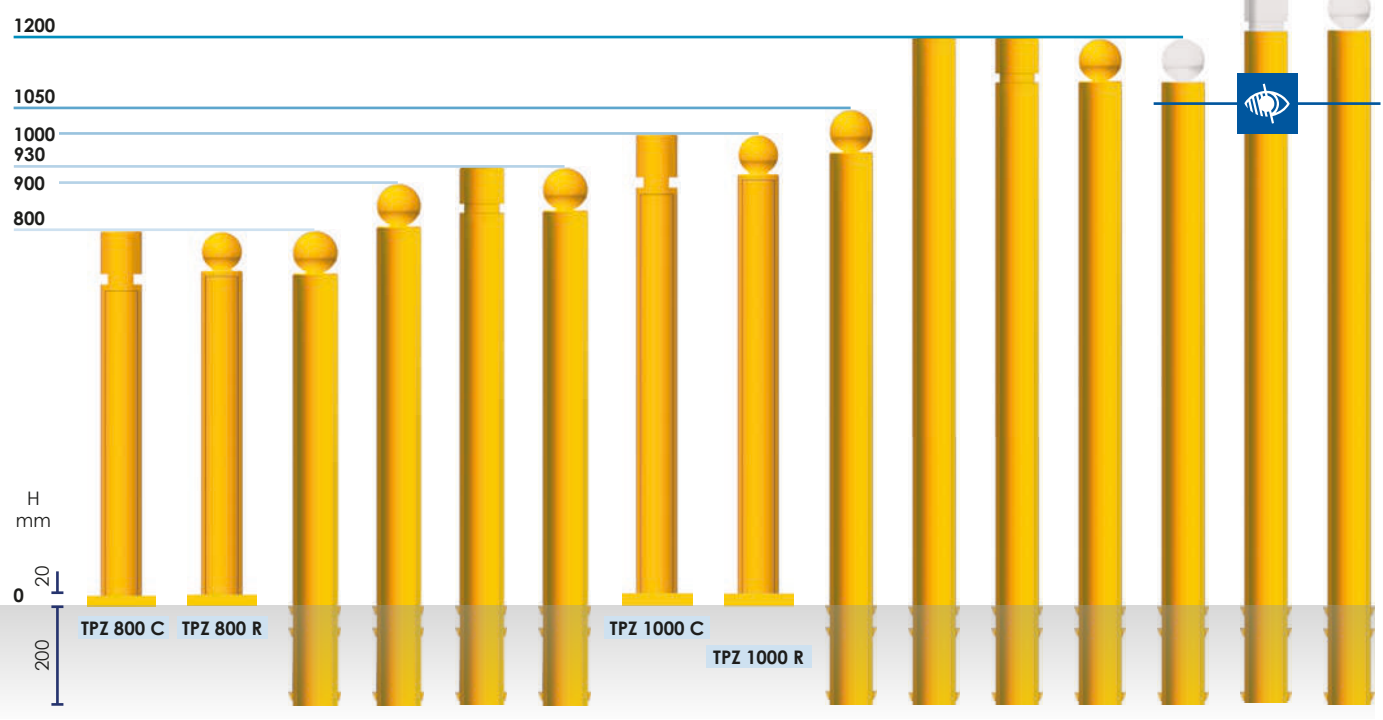

TPZ 800 C TPZ 800 R TPZ 880 R TPZ 980 R TPZ 1100 C TPZ 1100 R TPZ 1000 C TPZ 1000 R TPZ 1080 R TPZ 1280 P TPZ 1280 C TPZ 1280 R TPZ 1280 RB TPZ 1500 C TPZ 1500 R

<p><b>A</b> H 800 mm</p> <ul style="list-style-type: none"> <li>TPZ 800 CN</li> <li>TPZ 800 CV</li> </ul>	<p><b>E</b> H 930 mm</p> <ul style="list-style-type: none"> <li>TPZ 1100 CN</li> <li>TPZ 1100 CV</li> <li>TPZ 1100 CG</li> <li>TPZ 1100 CM</li> </ul>	<p><b>G</b> H 1000 mm</p> <ul style="list-style-type: none"> <li>TPZ 1000 CN</li> <li>TPZ 1000 CV</li> <li>TPZ 1000 C7044</li> </ul>	<p><b>K</b> H 1200 mm</p> <ul style="list-style-type: none"> <li>TPZ 1280 C7024</li> <li>TPZ 1280 C8011</li> </ul>	<p><b>N</b> H 1310 mm</p> <ul style="list-style-type: none"> <li>TPZ 1500 CNB ●</li> <li>TPZ 1500 CGB ●</li> <li>TPZ 1500 CMB ●</li> </ul>
---	---	--	--	--

<p><b>B</b> <b>C</b> H 800 mm</p> <ul style="list-style-type: none"> <li>TPZ 800 RN</li> <li>TPZ 800 RV</li> <li>TPZ 880 R6007</li> </ul>	<p><b>D</b> H 900 mm</p> <ul style="list-style-type: none"> <li>TPZ 980 RN</li> <li>TPZ 980 RG</li> </ul>	<p><b>F</b> H 930 mm</p> <ul style="list-style-type: none"> <li>TPZ 1100 RN</li> <li>TPZ 1100 RV</li> <li>TPZ 1100 RG</li> <li>TPZ 1100 RM</li> </ul>	<p><b>H</b> H 1000 mm</p> <ul style="list-style-type: none"> <li>TPZ 1000 RN</li> <li>TPZ 1000 RV</li> </ul>	<p><b>I</b> H 1050 mm</p> <ul style="list-style-type: none"> <li>TPZ 1080 RN</li> <li>TPZ 1080 RG</li> </ul>	<p><b>L</b> <b>M</b> H 1200 mm</p> <ul style="list-style-type: none"> <li>TPZ 1280 R7024</li> <li>TPZ 1280 R8011</li> <li>TPZ 1280 RB8011 ●</li> </ul>	<p><b>O</b> H 1310 mm</p> <ul style="list-style-type: none"> <li>TPZ 1500 RNB ●</li> <li>TPZ 1500 RGB ●</li> <li>TPZ 1500 RMB ●</li> <li>TPZ 1500 RB7024 ●</li> <li>TPZ 1500 RB8011 ●</li> </ul>
---	---	---	--	--	--	--



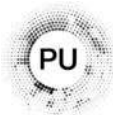

\* <math>-20\text{ }^\circ\text{C}</math> - Nous consulter  
 Ask us o Consultarnos  
 Uns konsultieren

RAL 9005 Autres couleurs : mini 5  
 RAL 6005 Others colors : mini 5  
 RAL 7016 Otros colores : mini 5  
 RAL 8017 Andere Farben



Option	Model	Height (mm)
Spherical top	TPU 40 CN	H 400 mm
	TPU 60 CN	H 400 mm
	TPU 800 CN	H 800 mm
	TPU 800 CV	H 800 mm
	TPU 1080 CN	H 800 mm
	TPU 1080 CV	H 800 mm
	TPU 1080 C3004	H 800 mm
	TPU 1080 CM	H 800 mm
	TPU 1000 CN	H 930 mm
	TPU 1000 CV	H 930 mm
Cylindrical top	TPU 1000 CA	H 930 mm
	TPU 1000 CM	H 930 mm
	TPU 1280 CB6009	H 1200 mm
	TPU 1300 CNB	H 1310 mm
	TPU 1300 CAB	H 1310 mm
	TPU 1300 CMB	H 1310 mm
	TPU 1300 RNB	H 1310 mm
	TPU 1300 RAB	H 1310 mm
	TPU 1300 RMB	H 1310 mm
	TPU 1300 RMA	H 1310 mm

Option	Model	Height (mm)
Spherical top	TPU 800 RN	H 800 mm
	TPU 800 RV	H 800 mm
Cylindrical top	TPU 1000 RN	H 930 mm
	TPU 1000 RV	H 930 mm
	TPU 1000 RA	H 930 mm
	TPU 1000 RM	H 930 mm



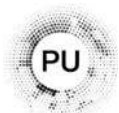

+ 50 °C  
- 20 °C\*

\* < -20 °C - Nous consulter  
Ask us o Consultarnos  
Uns konsultieren



RAL 9005

RAL 7016 \*

RAL 8017

Autres couleurs : mini 5  
Others colors mini 5  
Otros colores : mini 5  
Andere Farben

Code	Ø mm
(B) TPU 40 CN	100
(A) TPU 60 CN	100
(D) TPU 100 BK	80 / 60
(D) TPU 100 GR	80 / 60
(D) TPU 100 MA	80 / 60
(G) TPU 130 BKB	60 / 40
(G) TPU 130 GRB	60 / 40
(G) TPU 130 MAB	60 / 40
(F) TPU 114 PA *	114
(E) TP ANTIQUE *	80
(C) TP 167 N	167 / 110
(H) TPZ 1280 P	80

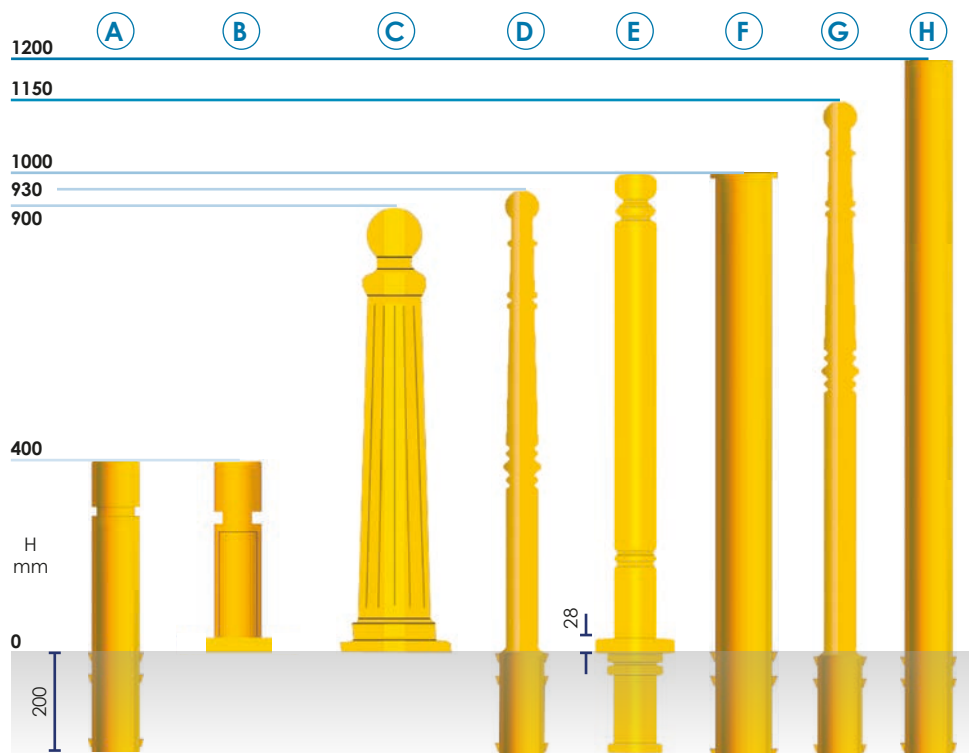

TPU 60 CN TPU 40 CN TP 167 N TPU 100 TPU 114 PA \* TP ANTIQUE \* TPZ 1280 P

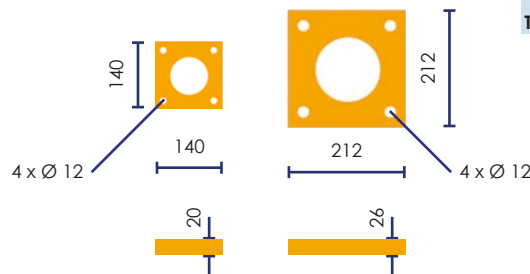

OPTION ○ OPTIONAL ○ OPCIÓN ○ OPTIONAL



TPU FIX 1 SB  
Ø 12 x 80



TPU RING  
TPZ RING



TPU TAPE  
TPU / TPZ / TPY  
TP ANTIQUE / TP 167



TP BOX 80  
TPZ / TPY  
TP ANTIQUE

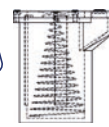

TP BOX 100  
TPU

\* Sauf Belgique ○ Except in Belgium ○ Salvo en Bélgica ○ Außer in Belgien

\* Sauf ○ Except ○ Salvo ○ Außer TPU 114 PA : RAL 7043





**PANNEAU SOLAIRE A LED** ◦ SOLAR LED TRAFFIC SIGN  
 PANEL DE TRAFICO CON LED ◦ VERKEHRSSCHILDER (SOLAR & LED)



▲ Autres dimensions : nous consulter. ◦ Other dimensions : ask us. ◦ Otras dimensiones : consultarnos. ◦ Andere Abmessungen: Kontaktieren Sie uns.

**À PERSONNALISER** ◦ TO CUSTOMIZE ◦ PERSONALIZAR ◦ ZU PERSONALISIEREN



Code	↗ mm
PNX-T50-XX	500
PNX-T70-XX	700
PNX-T100-XX	1000

Code	∅ mm
PNX-R 45 - XXX	450
PNX-R 65 - XXX	650
PNX-R 85 - XXX	850
PNX-R 105 - XXX	1050

Code	↗ mm
PNX-C50-XX	500 x 500
PNX-C70-XX	700 x 700

Code	∅ mm
PNX-H40-XX	400
PNX-H60-XX	600
PNX-H80-XX	800
PNX-H100-XX	1000

Code	↗ mm
PR-5070-XX	550 x 700

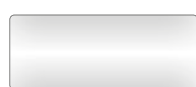

Code	↗ mm
PNX-M3-XX	300 x 150
PNX-M5-XX	500 x 200



Code	↗ mm
PNX-KC-XX	800 x 600



Code	∅ mm
PSTAT *	300

\* Panneau lumineux électrique à usage grand public / fixations par vis ◦ Electric light panel for por private use  
 Panel luminoso eléctrico para uso privado ◦ Elektrisches Lichtpaneel für den allgemeinen öffentlichen / Befestigung durch Schrauben





## PANNEAU SOLAIRE A LED

### SOLAR LED TRAFFIC SIGN ◦ PANEL DE TRAFICO CON LED ◦ VERKEHRSSCHILDER (SOLAR & LED)

- Panneau 3 en 1 : LED, panneau solaire et batterie
  - Panneau solaire : 0,3 W / durée de vie 10 000 heures
  - Batterie : # 18650 / 4400 mAh / 10 à 12 heures de fonctionnement sur batterie entièrement chargée
  - LED : couleur (ø 5 mm / 0,04 w) blanc (ø 5 mm / 0,06 w)
  - Nombre de LED en fonction de la taille / Clignotants 42/min
  - Intensité lumineuse du début : 6000mcd
  - Visibilité : 500M
  - Niveau de protection : IP65
  - Décoration : revêtement réfléchissant vinyle, Classe 2, revêtement EGP 3 M
  - Cadre Inox / aluminium
  - 2 rails à l'arrière pour la fixation
  - Température de fonctionnement : - 10 / +45°C
  - **Poteaux non inclus à la gamme**
- 3 in 1 panel: LED, solar panel and battery
  - Solar panel: 0.3 W / lifetime 10,000 hours
  - Battery: # 18650/4400 mAh / 10 to 12 hours of operation on fully charged battery
  - LED: color (ø 5 mm / 0.04 w) white (ø 5 mm / 0.06 w)
  - Number of LEDs according to the size / flashing 42/min
  - Light intensity from the beginning: 6000mcd
  - Visibility: 500M
  - Protection level: IP65
  - Decoration: vinyl reflective coating, Class 2, EGP coating 3 M
  - Stainless steel / aluminum frame
  - 2 rails at the back for fixing
  - Operating Temperature : - 10 / +45°C
  - **Posts are not included in our range**
- Panel 3 en 1: LED, panel solar y batería
  - Panel solar: 0,3 W / vida útil 10.000 horas
  - Batería: # 18650/4400 mAh / 10 a 12 horas de funcionamiento con una batería completamente cargada
  - LED : color (ø 5 mm / 0,04 w) blanco (ø 5 mm / 0,06 w)
  - Cantidad de LEDs según el tamaño / parpadeo 42/min
  - Intensidad de la luz desde el principio: 6000mcd
  - Visibilidad: 500M
  - Nivel de protección: IP65
  - Decoración: revestimiento reflectante de vinilo, Clase 2, revestimiento EGP 3 M
  - Marco de acero inoxidable / aluminio
  - 2 rieles en la parte trasera para la fijación
  - Temperatura de funcionamiento : - 10 / +45°C
  - **Postes no incluidos a la gama**
- 3-in-1-Panel: LED, Solarpaneel und Batterie
  - Solarpaneel: 0.3 W / Lebensdauer 10.000 Stunden
  - Akku: # 18650/4400 mAh / 10 bis 12 Stunden voll aufgeladener Akku
  - LED: Farbe (ø 5 mm / 0.04 w); weiß (ø 5 mm / 0.06 w)
  - Anzahl LEDs je nach Größe / Blinker 42/Min
  - Anfangslichtintensität: 6000mcd
  - Sichtbarkeit : 500M
  - Schutzniveau : IP65
  - Dekoration: reflektierende Vinyl-Beschichtung, Class 2, EGP 3 M Beschichtung
  - Rahmen Inox / Aluminium
  - 2 Schienen hinten zur Befestigung
  - Betriebstemperatur: - 10 / +45°C
  - **Posten nicht im Sortiment enthalten**



PNX R



PNX T



PNX C



PNX H \*



**INCLUS**  
INCLUDED ◦ INCLUIDO ◦ INKLUSIVE

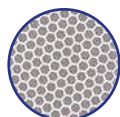
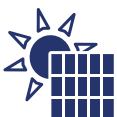
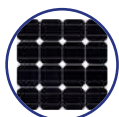

classe 2

**OPTION**  
OPTIONAL ◦ OPCIÓN ◦ OPTIONAL



**FIXATIONS NON INCLUSES** ◦ **FIXINGS NOT INCLUDED**  
FIJACIONES NO INCLUIDAS ◦ NICHT INKL. BEFESTIGUNGEN

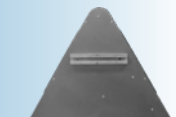

\* Panneau solaire déporté selon dimensions panneau ◦ Remote solar panel according to traffic sign dimensions  
Panel solar remoto según dimensiones de la señal ◦ Fernsolarpanel nach Panelabmessungen





Créa Luxe.fr

POD

**BANDE DE GUIDAGE** ◦ **TACTILE GUIDE STRIPS**  
**BANDA DE SEÑALIZACIÓN**  
**BODENLEITSTREIFEN**



Code	kg	Surface m² Surface Superficie Oberfläche
POD 104 BA	1,6	
POD 104 NR	1,6	0,2
POD 104 JA	1,6	



OPTION OPTIONAL ◦ OPCIÓN ◦ OPTIONAL

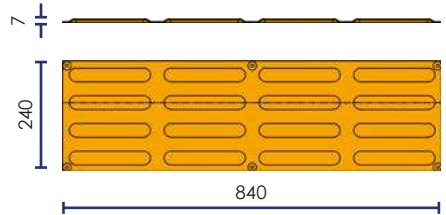

Code	kg	Surface m² Surface Superficie Oberfläche
POD 104 ALU	1,2	0,2



6 x Ø 6 mm, non fourni ◦ not supplied ◦ no incluido ◦ nicht enthalten

Code	kg
POD 29 LIS	0,30
POD 29 RE	0,30



POD 29 LIS



POD 29 RE

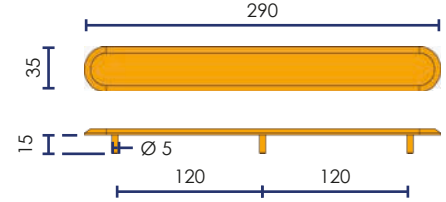

OPTION OPTIONAL ◦ OPCIÓN ◦ OPTIONAL

Gabarit de pose ◦ Laying template  
 Planfilla de instalación ◦ Verlegeschablone

POD 29 TOOL x 12

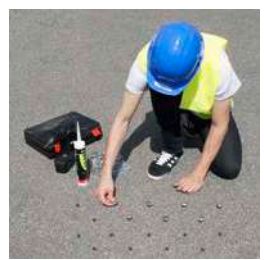
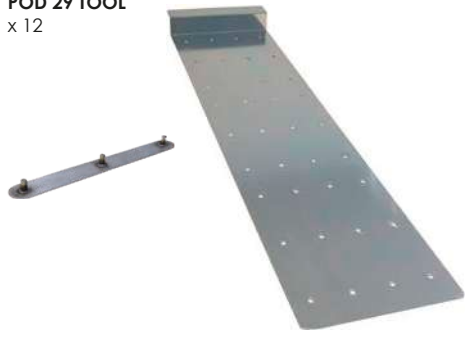





# POD

## CLOU PODOTACTILE ◦ TACTILE STUDS CLAVOS PODOTÁCTILES TAKTILE BODENLEITLINIEN UND NOPPEN



Code		
POD 25 STR	100	0,02
POD 25 LIN	100	0,02
POD 25 LINNR	100	0,02
POD 25 GOSTR	100	0,02



POD 25 STR



POD 25 LIN



POD 25 LINNR



POD 25 GOSTR

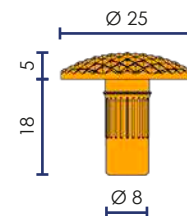

### OPTION OPTIONAL ◦ OPCIÓN ◦ OPTIONAL

Gabarit de pose ◦ Laying template  
Plantilla de instalación  
Verlegeschablone

► **POD 25**  
**POD TOOL 4060**  
x 99 588 x 400

Pour une longueur de 1 ml :  
Largeur 420 mm = 149 clous  
Largeur 620 mm = 216 clous



**PODSEAL**  
► p. 281

Code		
POD 35 LIS	100	0,03
POD 35 RE	100	0,03
POD 35 STR	100	0,03

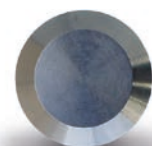

POD 35 LIS

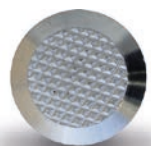

POD 35 RE



POD 35 STR

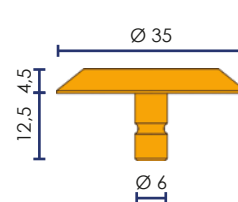

### OPTION OPTIONAL ◦ OPCIÓN ◦ OPTIONAL

Gabarit de pose ◦ Laying template  
Plantilla de instalación  
Verlegeschablone

► **POD 35**  
**POD 35 TOOL**  
x 120 1085 x 500



**PODSEAL**  
► p. 281

Code			Surface m <sup>2</sup> Surface Superficie Oberfläche
POD 42 CL		2	0,32
POD 81 CL		3,4	
POD 81 JA		3,4	0,50
POD 81 NR		3,4	

### CAOUTCHOUC RUBBER CAUCHO KAUTSCHUK

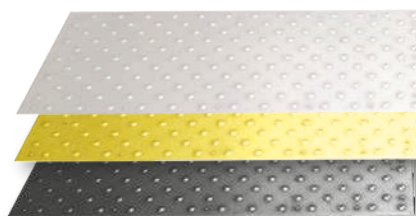

### OPTION ◦ OPTIONAL ► POD 42 OPCIÓN ◦ OPTIONAL



**PODGLUE 2**  
5 kg (± 1 kg/m<sup>2</sup>)  
2 kg (± 1 kg/m<sup>2</sup>)

► **POD 81 / POD 304 / POD 316** : 810 x 620  
**POD 42** : 770 x 420

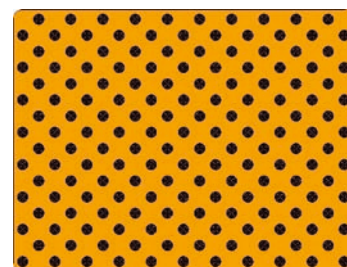

Code		Surface m <sup>2</sup> Surface Superficie Oberfläche
POD 81 ALU	2,2	0,50



Code		Surface m <sup>2</sup> Surface Superficie Oberfläche
POD 304 INOX *	7,5	
POD 316 INOX *	7,5	0,50



\* Sur commande ◦ Under request ◦ bajo pedido ◦ Auf Bestellung

POD 81 ALU / POD 304 / POD 316 : non fourni ◦ not supplied ◦ no incluido ◦ nicht enthalten



METROPOLITAIN

14







PDM

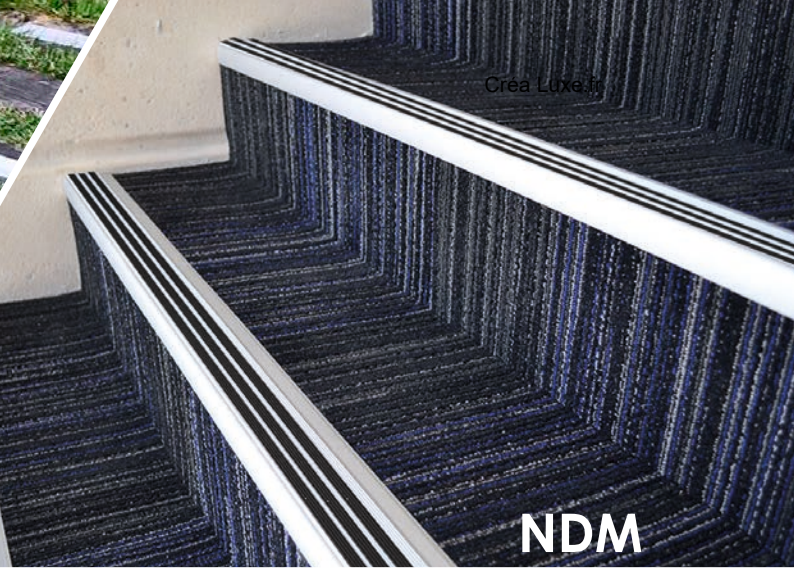

NDM

**NEZ DE MARCHE ANTIDÉRAPANT** ○ NON-SLIP STAIR NOSING  
**PERFIL ANTIDESLIZANTE PARA PELDAÑOS** ○ RUSTCHFEST TREPPENKANTENPROFIL



Code			
NDM 900 PVC	●	3 x 5 mm	0,80
NDM 900 BK	●		0,80
NDM 900 FLUO	●		0,80
NDM 1300 PVC	●	4 x 5 mm	1,20
NDM 1300 BK	●		1,20
NDM 1300 FLUO	●		1,20

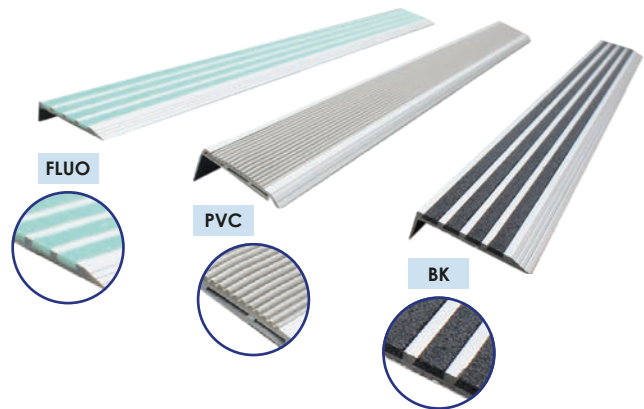

non fourni ○ not supplied ○ no incluido ○ nicht enthalten

NDM 900

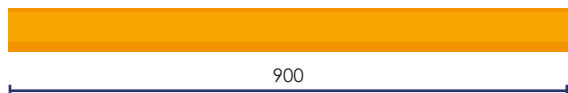

NDM 1300

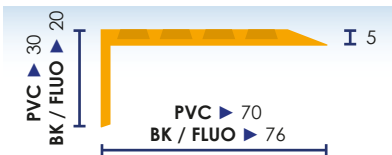
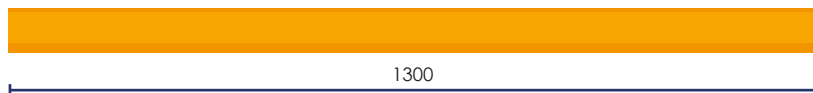

**PLAT DE MARCHE** ○ STAIRS PAD  
**PERFIL ANTIDESLIZANTE PARA PELDAÑOS** ○ TREPPENKANTEN



Code			
PDM 900 PVC	●	3 x 5 mm	0,80
PDM 900 BK	●		0,80
PDM 1300 PVC	●	4 x 5 mm	1,10
PDM 1300 BK	●		1,10

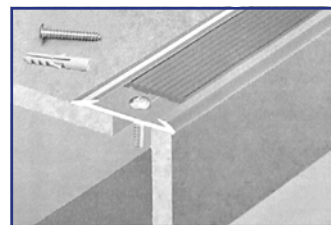

non fourni ○ not supplied ○ no incluido ○ nicht enthalten

PDM 900

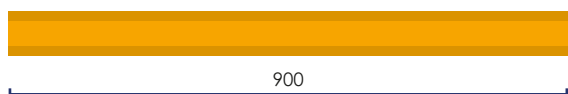

PDM 1300

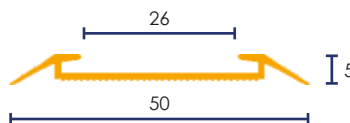
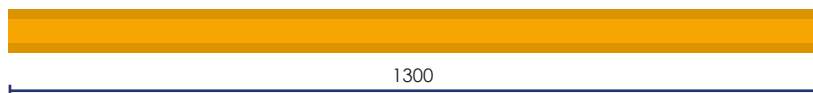

OPTION  
 OPCION  
 OPTIÖN



RQ GLUE









# PARKSTOP

## BUTÉE DE PARKING

RUBBER PARKING STOP ◦ TOPE DE RUEDAS EN CAUCHO ◦ PARKPLATZBEGRENZUNG



Code			
PARKSTOP 50	4	2	6,50
PARKSTOP 90	4	2	8,00
PARKSTOP 130	4	4	12,50
PARKSTOP 180	4	4	16,00



LED

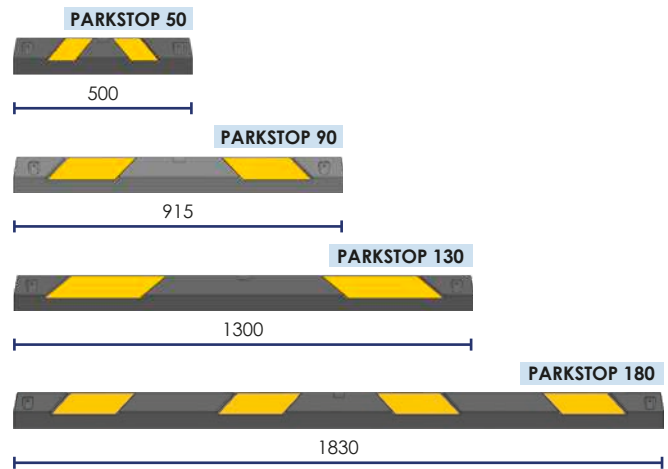

OPTION ◦ OPTIONAL ◦ OPCIÓN ◦ OPTIONAL



LED  
x 1



FSAFE 4 SB  
Ø 12 x 120



RQ GLUE

INCLUS ◦ INCLUDED ◦ INCLUIDO ◦ INKLUSIVE



SPIKES  
Ø 12 x 300



2 x 2



2 x Ø 20







PARKPLACE

TPX

## BUTÉE DE PARKING HAUTE VISIBILITÉ

HIGH VISIBILITY PROTECTION GUARD

TOPE DE RUEDAS ALTA VISIBILIDAD ○ PARKPLATZBEGRENZUNG



Code		
PARKPLACE 18 BU		14,40
PARKPLACE 18 JA		14,40
PARKPLACE 18 WH		14,40
PARKPLACE 18 BK		14,40

\* Peinture ○ Painting ○ Pintura ○ Farbe

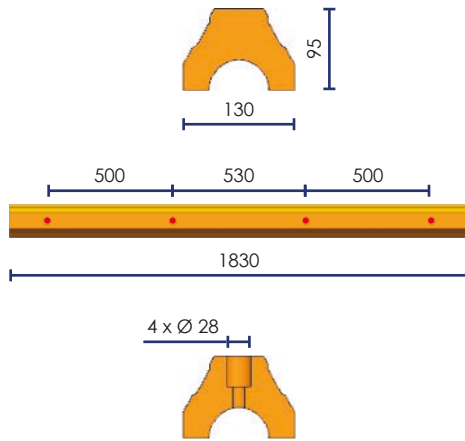

### OPTION OPTIONAL ○ OPCIÓN



## BUTÉE FLEXIBLE À MÉMOIRE DE FORME

FLEXIBLE PROTECTION BARS

TOPES DE PROTECCIÓN FLEXIBLES

FLEXIBEL RAMMSCHUTZBALKEN MIT FORMGEDÄCHTNIS

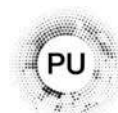

Code		
TPX 800 NJ	798 x 150 x 120	2,4
TPX 1200 NJ	1180 x 150 x 120	4,3
TPX 2000 NJ	1998 x 150 x 120	7,2

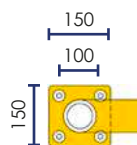
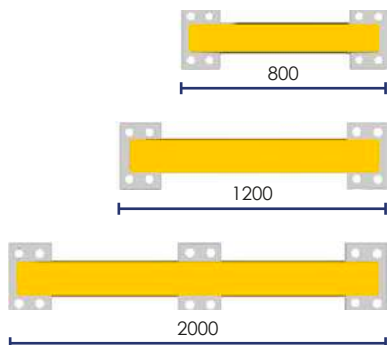

Capuchons ○ Caps  
Tapas ○ Kappen

OPTION  
OPCIÓN  
OPTIONAL



TPU FIX 1 SB  
Ø 12 x 80

\* < 20 °C - Nous consulter ○ Ask us ○ Consultarnos ○ Uns konsultieren





PARKLANE

**BORDURES DE BALISAGE**  
**WARNING BORDER**  
**TOPE DE SEÑALIZACIÓN** ◦ **TRENNBALKEN**



Code		
PARKLANE 1200	4	12,0
PARKLANE 1 MA	-	0,9
PARKLANE 1 FE	-	1,2

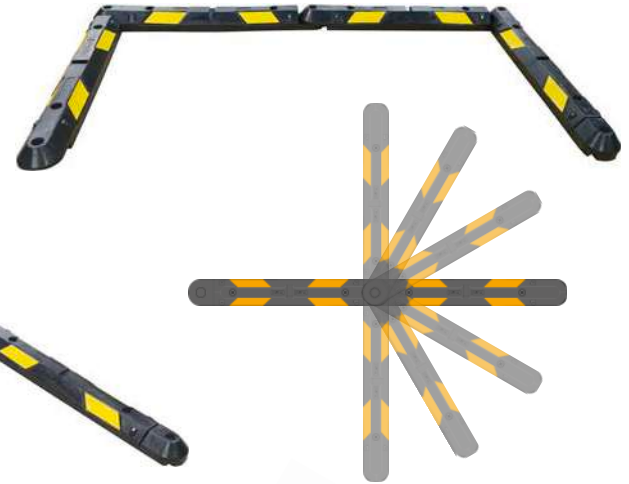
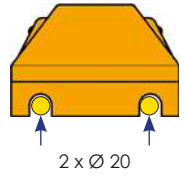

**INCLUS** ◦ **INCLUDED** ◦ **INCLUIDO** ◦ **INKLUSIVE**

2 x Ø 20

**OPTION** ◦ **OPTIONAL** ◦ **OPCIÓN** ◦ **OPTIONAL**

**LED**

**FSAFE 4 SB**  
Ø 12 x 120

**SPIKES**  
Ø 12 x 300





GALVANISATION SUR COMMANDE  
GALVANISATION : TO ORDER  
GALVANIZADO : BAJO PEDIDO  
VERZINKT: AUF ANFRAGE





## PARKSTEEL



## PARK

### BUTÉE DE PROTECTION ACIER ○ STEEL PROTECTION BAR TOPE DE PROTECCIÓN DE ACERO PARKPLATZBEGRENZUG AUS STAHL



PEINTURE ÉPOXY  
POWDER PAINTING  
PINTURA EPOXICA  
EPOXY FARBE

## PARK

Code	L		
PARK 6565 NJ	650 x 650	6	8,00
PARK 400 NJ	400	4	3,50
PARK 800 NJ	800	4	4,50
PARK 1200 NJ	1200	4	6,80

Ø 76 mm



OPTION ○ OPTIONAL ○ OPCIÓN ○ OPTIONAL

BAR FIX 1 SB (x 1)

BAR FIX 304 SB (x 4)

## PARKSTEEL

Code	L		
PARKSTEEL 80	830	4	6,70
PARKSTEEL 120	1230	4	8,40
PARKSTEEL 200	2030	6	14,00
PARKKORNER	185 x 185	4	5,00

Ø 75 mm

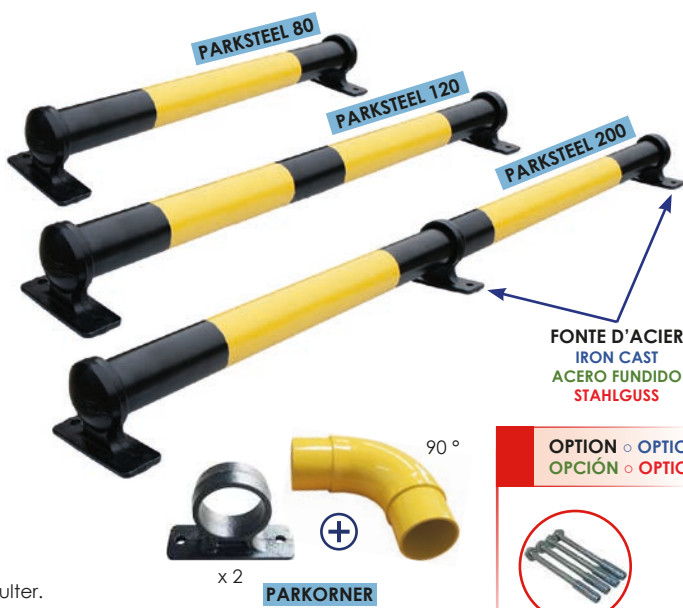
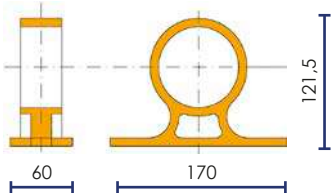

FONTE D'ACIER  
IRON CAST  
ACERO FUNDIDO  
STAHLGUSS

OPTION ○ OPTIONAL ○ OPCIÓN ○ OPTIONAL

FSAFE 4 SB  
Ø 12 x 120

Ne pas installer en milieu salin ou Hydrocarbure. Nous consulter.  
Do not install in saline or Oil environment. Contact us.  
No lo instale en un ambiente salino o hidrocarburo. Consúltenos.  
Soll nicht in Salz oder Kohlenstoff Umgebung installiert werden, /uns Konsultieren.





**BUT 1200**

**BUT 800**

**BUTÉE POIDS LOURD & CHARIOT ÉLEVATEUR**  
**TRUCK AND FORKLIFT BUMPER**  
**TOPE PARA CAMIONES Y CARRETTILLAS**  
**LKW-PARKPLATZBEGRENZUNG**



**BUT 800**



Code		
BUT 800	6 *	25,50
BUT 800 FIX	6 **	27,80

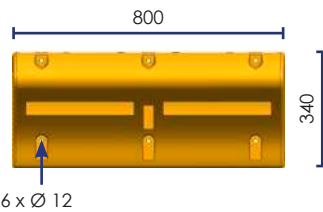
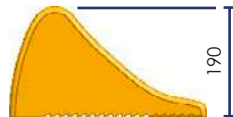

**INCLUS** ◦ INCLUDED  
**INCLUIDO** ◦ INKLUSIVE

**BUT 800 FIX**

\*\* FIXSAFE  
 Ø 12 x 120



**OPTION** ◦ OPTIONAL ◦ OPCIÓN ◦ OPTIONAL

\* FSFAE 2 SB  
 Ø 12 x 120

\* SPIKES  
 Ø 12 x 300

**LED**

**FLASH**

**BUT 1200**



Code		
BUT 1200	3 *	20,00
BUT 1200 FIX	3 **	22,30

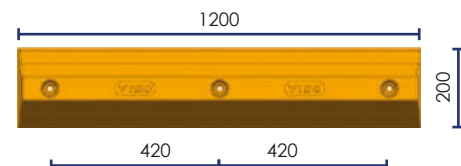
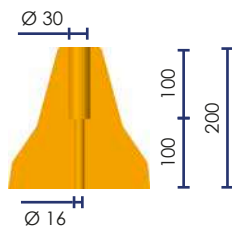

**INCLUS** ◦ INCLUDED  
**INCLUIDO** ◦ INKLUSIVE

**BUT 1200 FIX**

\*\* FIX 253 SB  
 Ø 16 x 250

**OPTION** ◦ OPTIONAL  
**OPCIÓN** ◦ OPTIONAL

\* FIX 253 SB  
 Ø 16 x 250

\* SPIKES 253 SB  
 Ø 14 x 350





**BUT 800 GAL**



**BAR CAM 3**

**BUTÉE ET GUIDE ROUE POIDS LOURD**

**TRUCK BUMPER** ◦ **TOPE PARA CAMIONES**  
**LKW-PARKPLATZBEGRENZUNG**



**BUT 800 GAL**



Code		
BUT 800 GAL	12 *	24,00
BUT 800 GALFIX	12 **	27,40

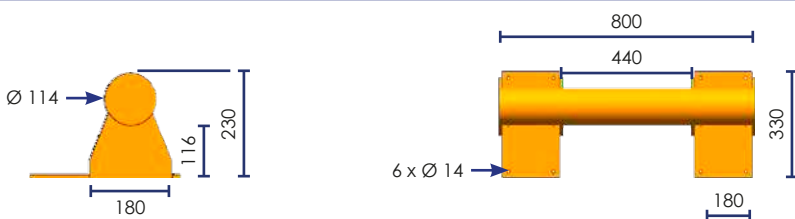

**INCLUS**  
**INCLUDED** ◦ **INCLUIDO** ◦ **INKLUSIVE**

**BUT 800 GALFIX**

**\*\* FSAFE 4 SB**  
Ø 12 x 120

**OPTION**  
**OPTIONAL** ◦ **OPCIÓN** ◦ **OPTIONAL**

**\* FSAFE 4 SB**  
Ø 12 x 120

**\* SPIKES**  
Ø 12 x 300

**BAR CAM 3**



Code		
BAR CAM 3	2 x 18 = 36 *	2 x 22,0 = 44
BAR CAM 3FIX	2 x 18 = 36 **	2 x 27,5 = 55

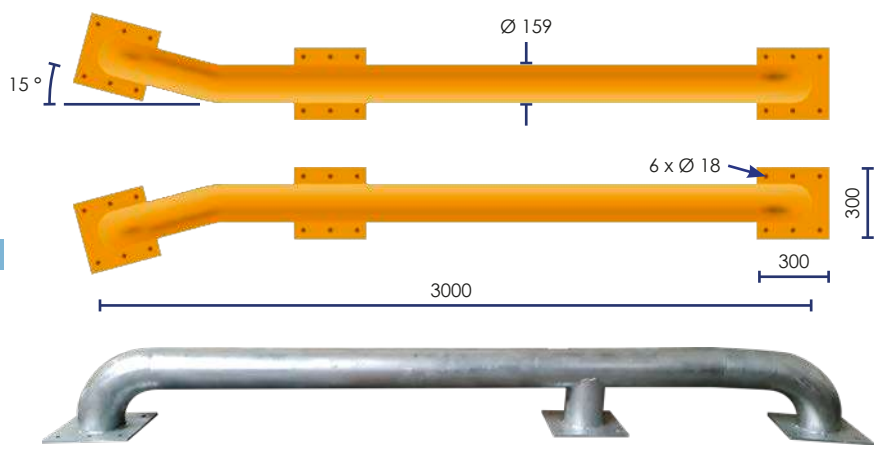

**INCLUS**  
**INCLUDED** ◦ **INCLUIDO** ◦ **INKLUSIVE**

**BAR CAM 3FIX**

**\*\* BAR CAM FIX 6 SB**  
Ø 16 x 200

**OPTION**  
**OPTIONAL** ◦ **OPCIÓN** ◦ **OPTIONAL**

**\* BAR CAM FIX 6 SB**  
Ø 16 x 200



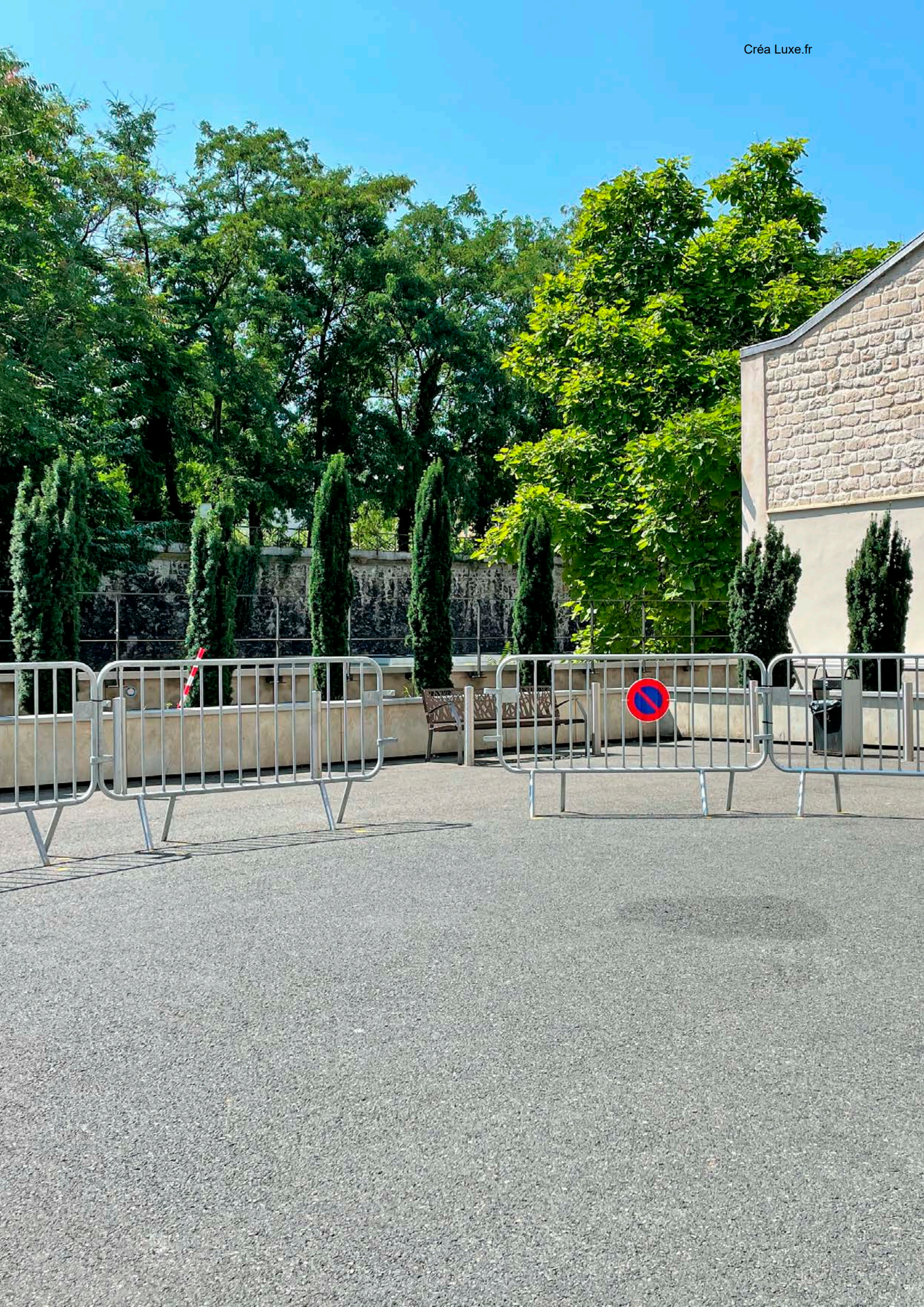





**BARPOL**



**BARPLA**

**BARRIÈRE DE POLICE ACIER GALVANISÉ À CHAUD**

**CROWD CONTROL BARRIER**

**VALLA DE SEGURIDAD DE ACERO** o **ABSPERRUNG AUS VERZINKTEM STAHL**



**BAR 14 PLA**

**BAR 18 PLA**

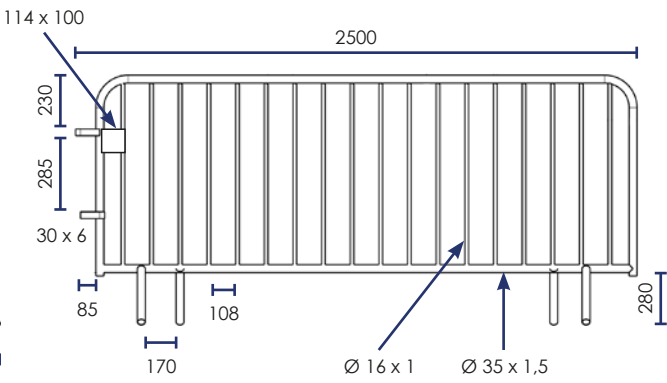
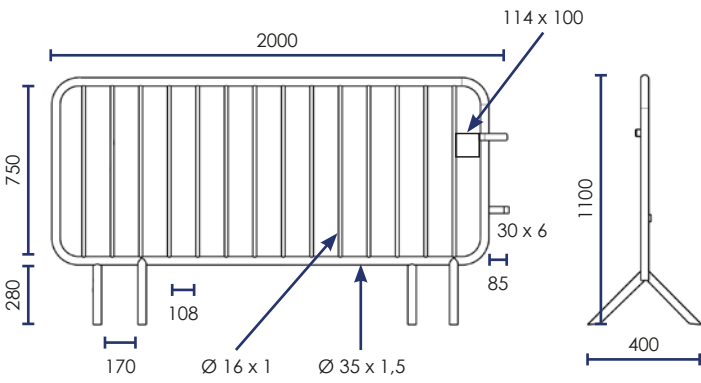

Code	L		kg
<b>BAR 14 PLA</b>	2000	14	14,00
<b>BAR 18 PLA</b>	2500	18	17,00

• Autre design sur commande o customized barrier under request  
 Personalización bajo pedido o Maßgeschneiderte Barrieren

• Sans plaque : sur commande, nous consulter.  
 Without plate, ask us.  
 Sin placa, consultarnos.  
 Plattenlos: auf Bestellung, uns konsultieren.

Code	L		kg
<b>BAR 14 POL</b>	2000	14	14,00
<b>BAR 18 POL</b>	2500	18	17,00







# BAR 1020 / 2020

## BARRIÈRES POLYPROPYLENE POLYPROPYLENE BARRIERS BARRERAS DE POLIPROPILENO ◦ SPERRGITTER

  
Classe 1 ◦ Class 1  
Clase 1 ◦ Klasse 1

 Autres couleurs : mini 50  
Others colors : mini 50  
Otros colores : mini 50  
Andere Farben : Mini 50



Code	
<b>BAR 2020 GR</b>	RAL 7035
<b>BAR 2020 OR</b>	RAL 2004



Pieds intégrés  
With heavy feet  
Pies integrados  
Integrierte Füße

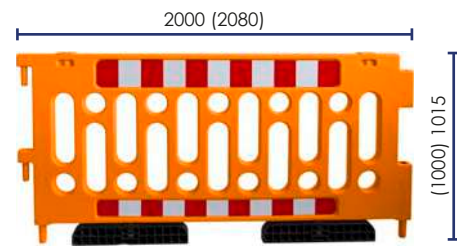
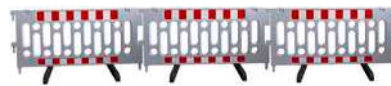

BAR 2020 OR

Code	
<b>BAR 2020 GR SP</b>	RAL 7035
<b>BAR 2020 OR SP</b>	RAL 2004



Pour base  
For base  
Para base  
Für sockel

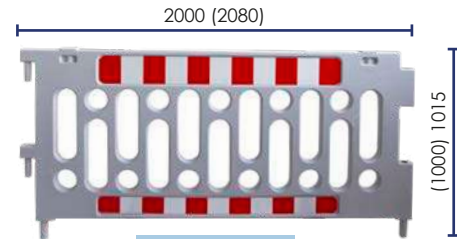

BAR 2020 GR SP

Code	
<b>BAR 1020 GR</b>	RAL 7035
<b>BAR 1020 OR</b>	RAL 2004



Pour base  
For base  
Para base  
Für sockel

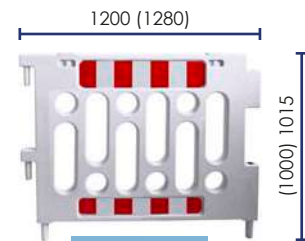

BAR 1020 GR

### OPTION ◦ OPTIONAL ◦ OPCIÓN ◦ OPTIONAL

BASE 2500

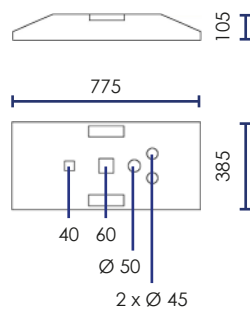

BASE 310

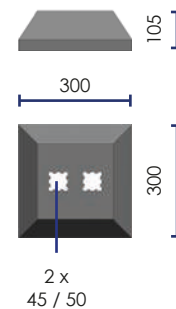

Poignée intégrée  
Built in handle  
Mango incorporado  
Handgriff



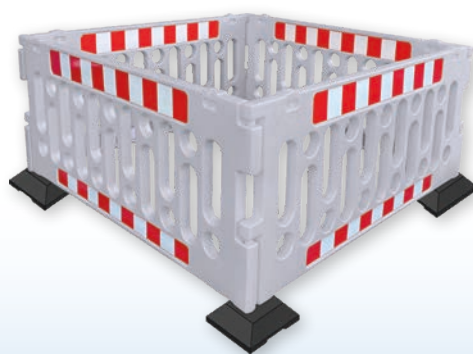

## 1200 X 1200

BAR 104 OR



BAR 134 OR



BAR 104 GR

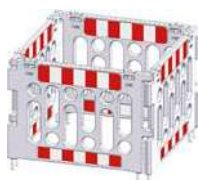

BAR 134 GR



## 2000 X 2000

BAR 204 OR



BAR 234 OR



BAR 244 OR



BAR 204 GR



BAR 234 GR



BAR 244 GR



OPTION ◦ OPTIONAL ◦ OPCIÓN ◦ OPTIONAL

Ø 180



LAMP SOL



360°



3 modes d'éclairage  
3 light modes  
3 modos de iluminación  
3 Positionen

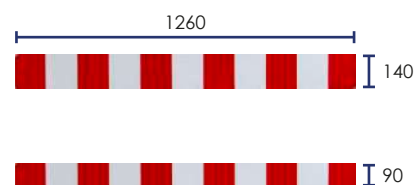

x 2  
BARTAPE 2  
Classe 2





## POTEAU INOX

STAINLESS STEEL POSTS ◦ POSTES DE ACERO INOXIDABLE ◦ EDELSTAHLPOSTEN

Code	Ø mm			kg
POT 89 316				3,90
POTS 89 316	89	Ø 170		5,00
POT BOX 89			135 x 135 H 300	4,50
POT 159 316				11,50
POTS 159 316	159	Ø 240		12,20
POT BOX 159			175 x 145 H 300	11,00

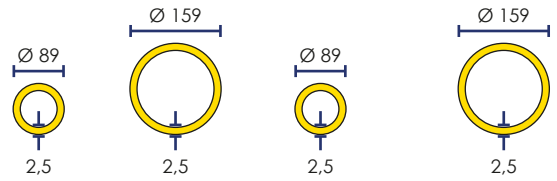

Fourni  
Supplied  
Includido  
Inklusive



POT BOX 89 / 159



800



POTS 89 316 POTS 159 316



POT 89 316



POT 159 316

## POTEAU ACIER

STEEL POSTS ◦ POSTES DE ACERO ◦ STAHLPOSTEN

Code		kg
POT 800 NJ ▲	●	7,3
POT 800 RB ▲	●	
POT 800 GAL	●	
POTS 800 NJ ▲	●	5,3
POTS 800 RB ▲	●	
POTS 800 GAL	●	



GALVA

GALVA

800

800



Ne pas installer en milieu salin ou Hydrocarbure. Nous consulter.  
Do not install in saline or Oil environment. Contact us.  
No lo instale en un ambiente salino o hidrocarburo. Consúltanos.  
Soll nicht in Salz oder Kohlenstoff Umgebung installiert werden,  
/uns Konsultieren.

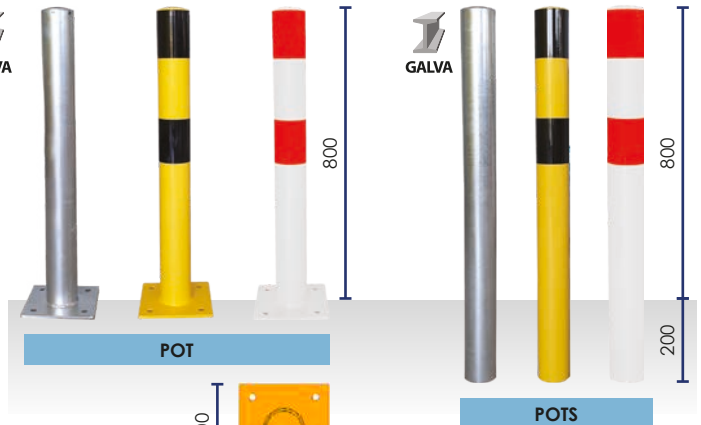

POT

POTS

OPTION ◦ OPTIONAL ◦ OPCIÓN ◦ OPTIONAL



BAR FIX 1 SB



BAR FIX 304 SB



- ▶ POT 2 RESB
- ▶ POT 2 ORSB
- ▶ POT 2 WHSB
- ▶ POT 2 BUSB
- ▶ POT 2 VERSB

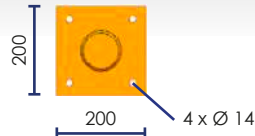









POT 757 GAL

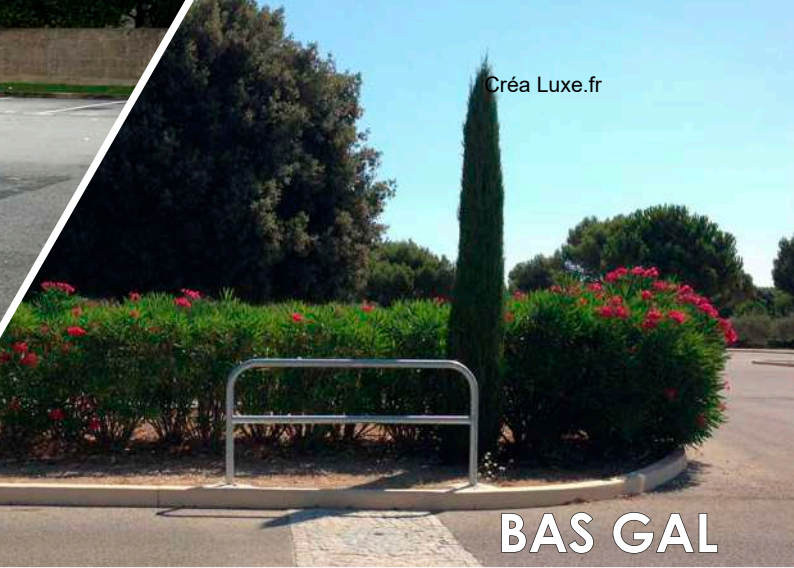

BAS GAL





**BARRIÈRE À SCELLER** ◦ **BARRIERS TO EMBED**  
**BARRERAS PARA EMPOTRAR** ◦ **RAMMSCHUTZBÜGEL ZU VERSIEGELN**



**GALVA** | **PEINTURE ÉPOXY**  
**POWDER PAINTING**  
**PINTURA EPOXICA**  
**EPOXY FARBE**

**Ø 40 mm**



Code		 kg
BAS 400 GAL		5,1
BAS 405 GAL		4,0

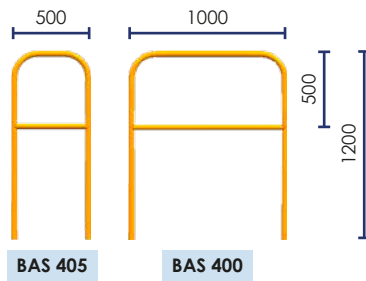

**Ø 60 mm**



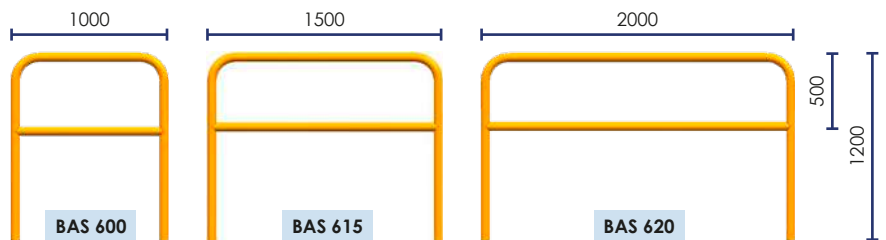

Code		 kg
BAS 600 V 		8,5
BAS 600 GAL		8,5
BAS 615 GAL		11,8
BAS 620 GAL		12,7



**Ø 40 mm**





**BAS 2000 V**  3,50



**Ø 40 mm**





**POT 76 R**  4,00



**Ø 40 mm**



**POT 162 V**  3,50



**Ø 60 mm**



**GALVA**

**POT 757 GAL**  8,00

**POTS 600 GAL**  9,50



 Ne pas installer en milieu salin ou Hydrocarbure. Nous consulter. ◦ Do not install in saline or Oil environment. Contact us.  
 No lo instale en un ambiente salino o hidrocarburo. Consúltenos.  
 Soll nicht in Salz oder Kohlenstoff Umgebung installiert werden. /uns Konsultieren.

\* Autres couleurs sur commande ◦ Other colors to order ◦ Otros colores bajo pedido ◦ Andere farben auf anfrage





**BAS**

**BASOL**

**BBASE**

 <b>BAS SIM GAL</b>	<b>BAS 40 SIM GAL</b> <span style="border: 1px solid red; border-radius: 50%; padding: 2px;">Ø 40 mm</span> 	<b>BAS 60 SIM GAL</b> <span style="border: 1px solid red; border-radius: 50%; padding: 2px;">Ø 60 mm</span> 
	<b>BAS 40 DOU GAL</b> 	<b>BAS 60 DOU GAL</b> 
 <b>BASOL GAL</b>	<b>BASOL 40 GAL</b> 	<b>BASOL 60 GAL</b> 
	<b>BASOL 40 DO GAL</b> 	<b>BASOL 60 DO GAL</b> 
 <b>BBASE</b>	<b>BBASE 40</b> 	<b>BBASE 60</b> 
	<b>BBASE 40 DOU</b> 	<b>BBASE 60 DOU</b> 





BAR GAL

BAR INOX

## BARRIÈRE À FIXER

BARRIERS TO FIX ◦ BARRERA CON BASE ◦ RAMMSCHUTZBÜGEL MIT PLATTE

Code		
BAR 500 GAL	500 x 250	4,00

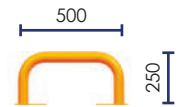
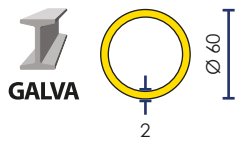

Code		
BAR 400 INOX	1000 x 1000	6,80
BAR 415 INOX	1500 x 1000	8,50
BAR 420 INOX	2000 x 1000	9,60

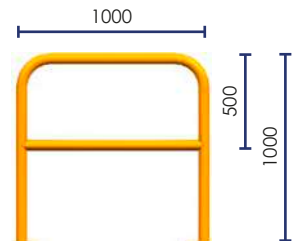

Code		
BAR 400 GAL	1000 x 1000	6,80
BAR 415 GAL	1500 x 1000	8,50
BAR 420 GAL	2000 x 1000	9,60

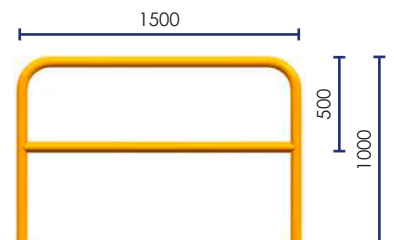
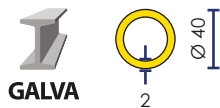

Code		
BAR 600 GAL	1000 x 1000	9,70
BAR 615 GAL	1500 x 1000	12
BAR 620 GAL	2000 x 1000	13,8

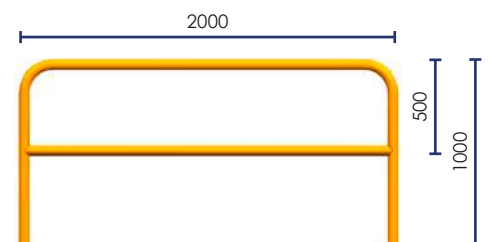
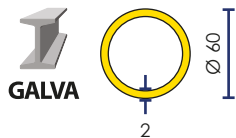

Bords arrondis  
Rounded edges  
Bordes redondeadas  
Abgerundete Ecken



Espace limité entre 2  
Limited space between 2  
Espacio limitado entre 2  
Begrenzter Raum zwischen 2

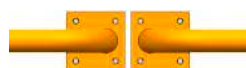

Autres couleurs ► p. 134 ◦ Other colors ► p. 134  
Otros colores ► p. 134 ◦ Andere farben ► p. 134

### OPTION ◦ OPTIONAL ◦ OPCIÓN ◦ OPTIONAL



BAR FIX 1 SB



BAR FIX 8 SB



BAR FIX 304 SB

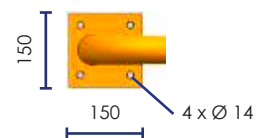





**STOPOST**

**STOPCAR**

**POTEAU DE PARKING RABATTABLE**

**FOLDING PARKING POST** ◦ **POSTE DE APARCAMIENTO ABATIBLE** ◦ **KIPP-PFOSTEN**



**PEINTURE ÉPOXY**  
POWDER PAINTING  
PINTURA EPOXICA  
EPOXY FARBE

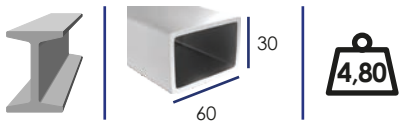

Code	
STOPOST	11



BASE FONTE  
200 x 60 x H 80  
CAST IRON BASE  
HIERRO FUNDIDO  
GUSSEISEN BASIS

**INCLUS** ◦ **INCLUDED** ◦ **INCLUIDO** ◦ **INKLUSIVE**

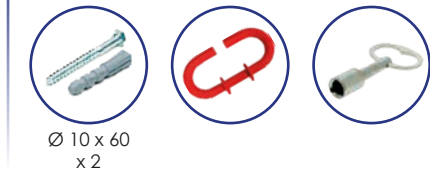

**ARCEAU DE PARKING AVEC CADENAS** ◦ **PARKING HOOP WITH PADLOCK**

**BARRERA DE APARCAMIENTO CON CANDADO** ◦ **PARKBÜGEL MIT SCHLOSS**

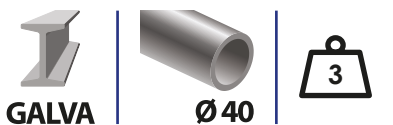

Code	
STOPCAR	
STOPCAR 50	

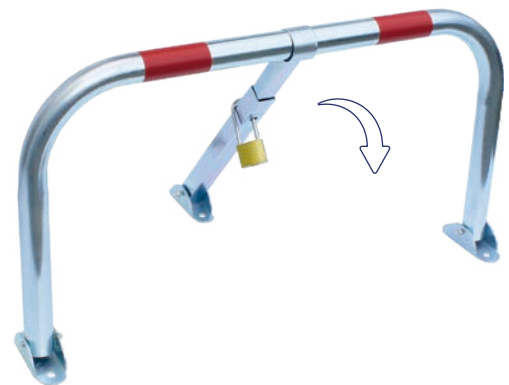

**INCLUS**  
**INCLUDED** ◦ **INCLUIDO** ◦ **INKLUSIVE**

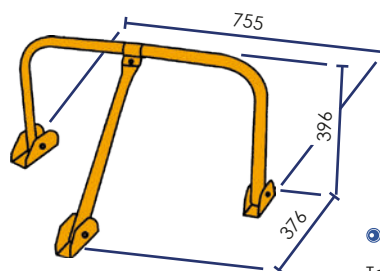

Tous les arceaux d'une commande ont le même cadenas  
All the parking hoop of an order have the same padlock  
Todas las barreras de un pedido tienen el mismo candado  
Alle Parkbügel einer Bestellung haben das gleiche Vorhängeschloss





# STOPWHEEL



# STOPRO

Créa Luxe.fr

## STOPWHEEL



ZINGUÉ  
ZINC  
CINCADO  
VERZINKTEM

Code	Key icon
STOPWHEEL	
STOPWHEELPASS *	
STOPWHEEL 50	
STOPWHEEL 100	
STOPWHEEL 114	

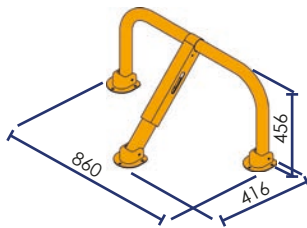
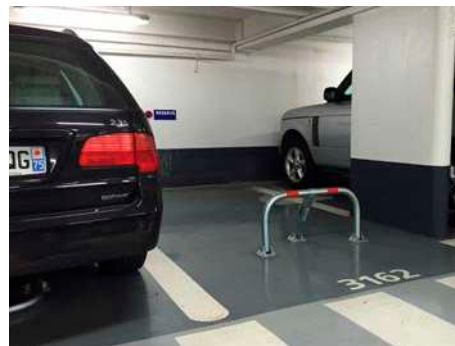

## STOPRO



Code	Key icon
STOPROJA	
STOPROJAPASS *	
STOPRO 50JA	
STOPRO 100JA	
STOPRO 114JA	

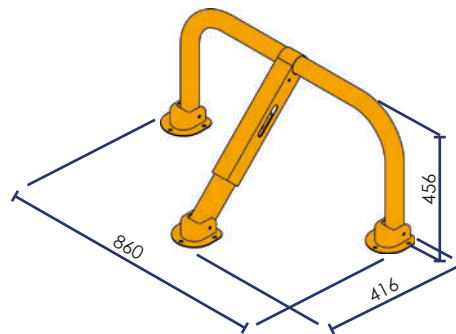

Tous les arceaux d'une commande ont la même serrure  
All the parking hoop of an order have same lock  
Todas las barreras de un pedido tienen la misma cerradura  
Alle Parkbügel einer Bestellung haben das gleiche Schloss

**INCLUS**  
INCLUDED ◦ INCLUIDO ◦ INKLUSIVE



Ø 10 x 80  
x 9

STOPRO - STOPWHEEL



**OPTION** ◦ OPTIONAL  
OPCIÓN ◦ OPTIONAL



TPU FIX 1 SB  
Ø 12 x 80

\* **MASTERKEY**

Pour ouvrir avec clé passe partout :  
minimum de commande : 5.  
To open with a master key : MOQ = 5 pcs.  
Para abrir con llave maestra :  
pedido mínimo : 5.  
Zum Öffnen mit einem Hauptschlüssel:  
Mindestbestellmenge : 5.











# STOPFRAME / STOPBLOCK



# STOPBLOCK

**STOPBLOCK** GALVA      Fonte d'acier galvanisé à chaud / Hot-dip galvanized cast iron / Hierro fundido galvanizado / Feuerverzinkter Stahlguss

Code	
STOPBLOCK	
STOPBLOCKPASS *	 
STOPBLOCK 50	
STOPBLOCK 100	 11
STOPBLOCK 114	 14

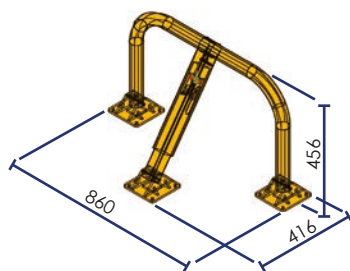

 Tous les arceaux d'une commande ont la même serrure  
All the parking hoop of an order have same lock  
Todas las barreras de un pedido tienen la misma cerradura  
Alle Parkbügel einer Bestellung haben das gleiche Schloss

**INCLUS** / INCLUDED / INCLUIDO / INKLUSIVE

Ø 10 x 80 x 12

ou / or / oder

**OPTION** / OPTIONAL / OPCIÓN / OPTIONAL





TPU FIX 1 SB  
Ø 12 x 80

 **MASTERKEY**  
Pour ouvrir avec clé passe partout : minimum de commande : 5.  
To open with a master key : MOQ = 5 pcs.  
Para abrir con llave maestra : pedido mínimo : 5.  
Zum Öffnen mit einem Hauptschlüssel : Mindestbestellmenge: 5.

**STOPFRAME**  **CAOUTCHOUC VULCANISÉ** / VULCANIZED RUBBER / CAUCHO VULCANIZADO / VULKANISIERTEM KAUTSCHUK

**STRUCTURE AUTOPORTANTE** ▶ STOPBLOCK  
PARKING HOOP FRAME  
BASE EMPOTRABLE  
SELBSTUNTERSTÜTZENDE STRUKTUR

Code	 
STOPFRAME	1200 x 900 x H 85

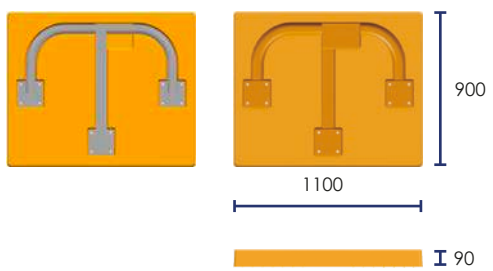

**INCLUS** / INCLUDED / INCLUIDO / INKLUSIVE



12 écrous + boulons pour fixation STOPBLOCK  
12 bolts and nuts for STOPBLOCK fixation  
12 tuercas + tornillos para fijación STOPBLOCK  
12 Muttern + Schrauben zur STOPBLOCK-Befestigung







# STOPCRASH

# STOPUSH

## STOPCRASH



Fonte d'acier galvanisé à chaud  
Hot-dip galvanized cast iron  
Hierro fundido galvanizado  
Feuerverzinkter Stahlguss

**HAUTE RÉSIDENCE À RESSORTS** ◦ HEAVY DUTY WITH SPRINGS  
ALTA RESISTENCIA CON RESORTES ◦ HOHER WIDERSTAND DURCH FEDER

Code	Key
STOPCRASH	
STOPCRASHPASS *	
STOPCRASH 50	
STOPCRASH 100	11
STOPCRASH 114	14

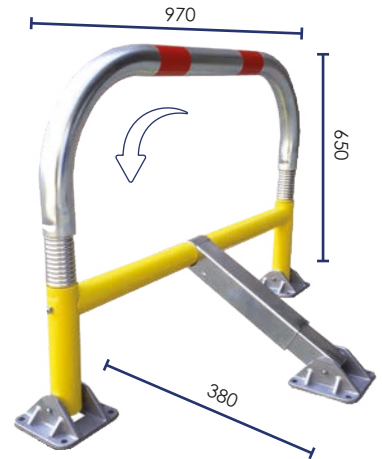

## STOPUSH

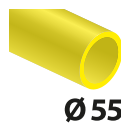
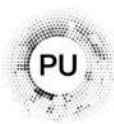

Fonte d'acier galvanisé à chaud  
Hot-dip galvanized cast iron  
Hierro fundido galvanizado  
Feuerverzinkter Stahlguss

**MÉMOIRE DE FORME** ◦ FLEXIBLE PARKING HOOP  
BARRERA FLEXIBLE ◦ FORMGEDÄCHTNIS

Code	Key
STOPUSH	
STOPUSHPASS *	
STOPUSH 50	
STOPUSH 100	11
STOPUSH 114	14

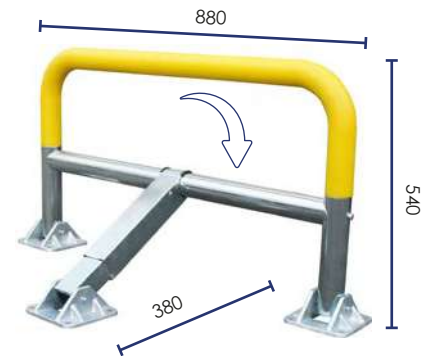

► STOPCRASH / STOPUSH

**INCLUS**  
INCLUDED ◦ INCLUIDO ◦ INKLUSIVE

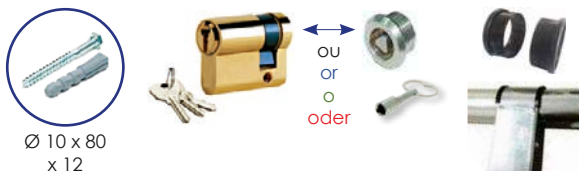

Ø 10 x 80  
x 12

Tous les arceaux d'une commande ont la même serrure  
All the parking hoop of an order have same lock  
Todas las barreras de un pedido tienen la misma cerradura  
Alle Parkbügel einer Bestellung haben das gleiche Schloss

► STOPCRASH / STOPUSH

**OPTION** ◦ OPTIONAL  
OPCIÓN ◦ OPTIONAL



TPU FIX 1 SB  
Ø 12 x 80

\* **MASTERKEY**  
Pour ouvrir avec clé passe partout :  
minimum de commande : 5.  
To open with a master key : MOQ = 5 pcs.  
Para abrir con llave maestra :  
pedido mínimo : 5.  
Zum Öffnen mit einem Hauptschlüssel:  
Mindestbestellmenge: 5.





LOCAR / LOCAM



STOPSOL

## STOPSOL



ZINGUÉ  
ZINC  
ZINCADO  
VERZINKTEM

+ 40 °C  
- 5 °C

### ARCEAU DE PARKING AUTOMATIQUE ◦ SOLAR PARKING HOOP ARCO PARA PARKING ABATIBLE AUTOMÁTICO ◦ SOLAR PARKBÜGEL

Code		
STOPSOL	2	600 X 400



Ø 8 x 70  
x 3



Ø 38

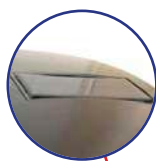

- Batterie lithium : IP 94 V0 - 6 V / 12 AH. Dimensions : 150 x 93 x 50, temps de chargement 2 h.
- Vitesse ouverture / fermeture : 5 s / 6 s.
- Utilisation sans soleil : environ 2 mois pour une utilisation 4 fois par jour.
- Télécommande : détectée dans un rayon de 15 m. Les télécommandes d'un STOPSOL n'ouvrent pas les autres.
- Important : Une sirène s'active en cas de choc sur l'arceau.
- Possibilité de commander une télécommande supplémentaire (réf. : STOPSOLTEL).

- Battery : IP 94 V0 - 6 V / 12 AH. Size : 150 x 93 x 50, charging time : 2 hours.
- Opening / closing speed : 5 s / 6 s.
- Use without sun : about 2 months using it 4 times a day.
- Remote detected at around 15 m. Remote can open only the assigned STOPSOL.
- Important : a siren is activated in case of shock with the barrier.
- Additional remote control available (ref : STOPSOLTEL).

- Bateria : IP 94 V0 - 6 V / 12 AH. Dimensiones : 150 x 93 x 50, tiempo de carga 2 h.
- Velocidad : apertura / cierre: 5 s / 6 s.
- Uso sin sol : unos 2 meses con un uso de 4 veces al día.
- Control remoto : Detectado en un área de 15 m. Los mandos a distancia de un STOPSOL no abren los demás.
- Importante: se activa una sirena en caso de impacto en el arco.
- Mando a distancia adicional disponible (ref: STOPSOLTEL).

- AKKU : SPF 94 V0 - 6 V / 12 AH. Abmessungen : 150 x 93 x 50, ladezeit 2 h.
- Geschwindigkeit öffnen / schließen : 5 s / 6 s.
- Verwendung ohne Sonne : Ca. 2 Monate für eine Anwendung 4-mal täglich.
- Fernbedienung : in einem umkreis von 15 m erkennen. Die fernbedienungen eines STOPSOL öffnen die anderen nicht.
- Wichtig : alarm wird beim aufprall auf den bügel aktiviert.
- Möglichkeit, eine zusätzliche Fernbedienung zu bestellen (Ref.: STOPSOLTEL).

## SABOT ANTI-VOL

### WHEEL BLOCKING SYSTEM ◦ CEPO ANTIRROBO ◦ RADKRALLE



Code			
LOCAR	≤ 11,5"	800 x 300 x 240	8
LOCAM	12 ≤ ≤ 20"	900 x 390 x 280	10







**WHEELTRUCK**

**WHEELSTOP**

**CALE ROUE POUR VOITURE ET POIDS LOURDS** ◦ **CAR AND TRUCK WHEEL CHOCK**  
**CALZO PARA RUEDA DE COCHE Y CAMION** ◦ **RADSTOPP FÜR PKW UND LKW**

Code				
CARSTOP	X		195 x 100 x 150	2,10
WHEELSTOP		X	340 x 200 x 190	8
WHEELTRUCK		X	387 x 168 x 177	1,35
WHEELPARK	X	X	500 x 150 x 100	6,50

**CARSTOP**

**CAOUTCHOUC VULCANISÉ**  
**VULCANIZED RUBBER**  
**CAUCHO VULCANIZADO**  
**VULKANISIERTEM KAUSCHUK**



**WHEELPARK**

**CAOUTCHOUC VULCANISÉ**  
**VULCANIZED RUBBER**  
**CAUCHO VULCANIZADO**  
**VULKANISIERTEM KAUSCHUK**



**WHEELTRUCK**

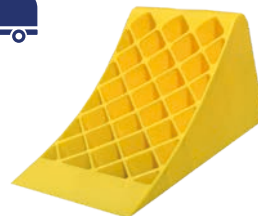

**WHEELSTOP**

**CAOUTCHOUC VULCANISÉ**  
**VULCANIZED RUBBER**  
**CAUCHO VULCANIZADO**  
**VULKANISIERTEM KAUSCHUK**



NORME  
 ECE R27

**TRIANG**

**TRIANGLE DE SIGNALISATION** ◦ **WARNING TRIANGLE**  
**TRIÁNGULO DE SEÑALIZACIÓN** ◦ **WARNDREIECK**

Code		
TRIANG	440 x 380 x 440 (440 x 140 x 30)	0,62







**RAMPE DE PORTAIL ◦ GATE RAMP**  
**RAMPA DE ENTRADA ◦ EINFahrtschwelle vor einem Tor**

CAOUTCHOUC  
 RUBBER  
 CAUCHO  
 KAUSCHUK

Code	
WARN 1200	5

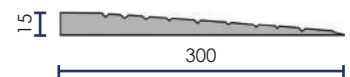
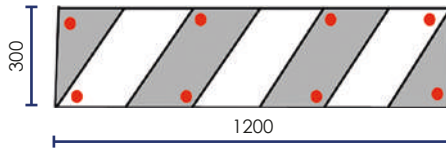

OPTION ◦ OPTIONAL  
 OPCIÓN ◦ OPTIONAL



FIXSAFE  
x 8



RQ GLUE

**SIGNALISATION DE VIRAGE / PARKING**  
**PARKING RAMP SIGN ◦ SEÑAL PARA APARCAMIENTO ◦ SIGNALISIERUNG**

CAOUTCHOUC  
 RUBBER  
 CAUCHO  
 KAUSCHUK

Code	
WALL 1200	4,60



x 15  
 Réflecteurs  
 Eye cuts  
 Reflectores  
 Reflektoren

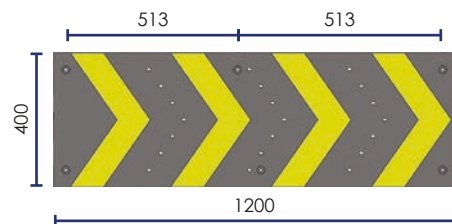

INCLUS ◦ INCLUDED  
 INCLUIDO ◦ INKLUSIVE



x 6

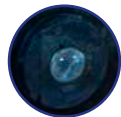

x 15



**ADHÉSIF / MARQUAGE AU SOL EXTÉRIEUR**  
**FLOOR STICKERS ◦ STICKERS PARA SUELO ◦ BODENSTICKER**

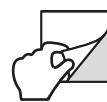

SOLEX 560 HAND  
60 x 50



SOLEX 500 OBLI  
Ø 50



SOLEX 500 PIET  
Ø 50



x 10 (5 + 5)

SOLEX 280 PAS  
28 x 10



x 2  
 SOLEX 845 PERS  
80 x 45



SOLEX 500 SENS  
Ø 50



SOLEX 500 STAT  
Ø 50



x 5

SOLEX 305 FLEC  
30 x 5



x 3  
 SOLEX 100 ZEBRA  
100 x 25





MR / MD



MH

**MIROIR D'AGGLOMÉRATION** ◦ **AGGLOMERATION MIRROR**  
**ESPEJO DE AGLOMERACIÓN** ◦ **VERKEHRSSPIEGEL**



**MH**

France : conforme à l'arrêté du 21/09/1981 relatif à la signalisation routière

Code	m		kg
MH 69	10		4,6
MH 129	15	130°	7,0
MH 99	12		6,5

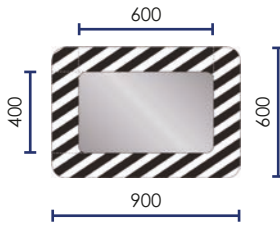

MH 69

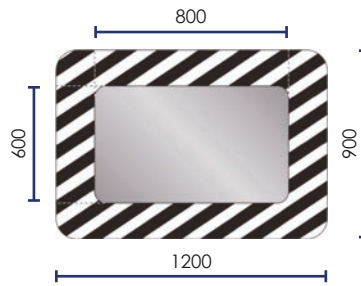

MH 129

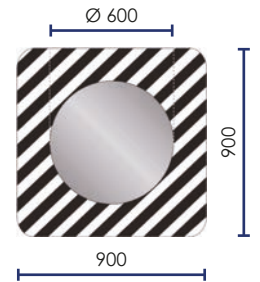

MH 99

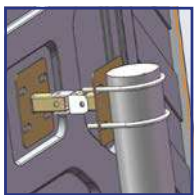

Avec fixation Ø 60 mm  
 With fixation  
 Con fijaciones  
 Mit Befestigung

**MR / MD**

Code	m		kg
MD 45 RB	7		2,3
MD 60 RB	12		2,6
MD 80 RB	20	130°	4,5
MR 3054 RB	10		2,5
MR 5684 RB	20		6,2



Réfléchissant  
 Reflective  
 Reflectivo  
 Reflektierend  
**CLASSE 2**



MR 3054 RB



MR 5684 RB

Avec fixation Ø 60 mm selon modèle (A / B)  
 With fixation depending on model (A / B)  
 Con fijaciones según referencia (A / B)  
 Mit Befestigung nach Modell (A / B)

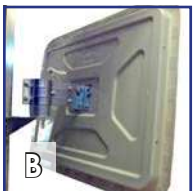
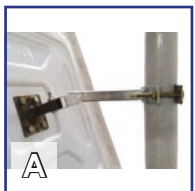

MD 45 RB



MD 60 RB



MD 80 RB





MIROIR

M 450 / 600 / 800

## MIROIR DE SÉCURITÉ

MIRRORS ○ ESPEJO ○ SICHERHEITSSPIEGEL

Code		
	m	130°
<b>MIROIR</b>	5	130°



Tige flexible 30 cm  
Flexible stem  
Varilla flexible  
Flexibler Stab

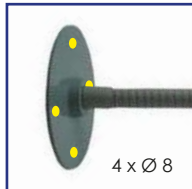

MIROIR



Code		
	m	130°
<b>M 450</b>	10	
<b>M 600</b>	15	130°
<b>M 800</b>	25	



Avec fixation Ø 60 mm selon modèle (A / B)  
With fixation depending on model (A / B)  
Con fijaciones según referencia (A / B)  
Mit Befestigung nach Modell (A / B)

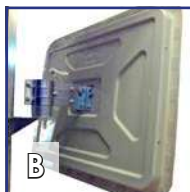
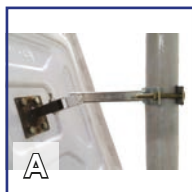

Code		
	m	130°
<b>M 4161</b>	10	
<b>M 5177</b>	20	130°



M 5177

Avec fixation Ø 60 mm selon modèle (A / B)  
With fixation depending on model (A / B)  
Con fijaciones según referencia (A / B)  
Mit Befestigung nach Modell (A / B)

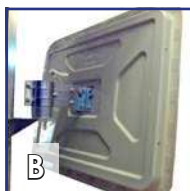
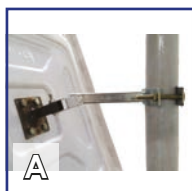





VELORACK



VELO 1

## RACK À VÉLO

BICYCLE RACK ◦ APARCA BICICLETA ◦ FAHRRADSTÄNDER

### VELO 1

Sol / mur  
Wall / floor  
Piso / Pared  
Boden / Wand



Extensible  
Expandable  
Extensible  
Ausziehbar



ZINGUÉ  
ZINC  
CINCADO  
VERZINKTEM

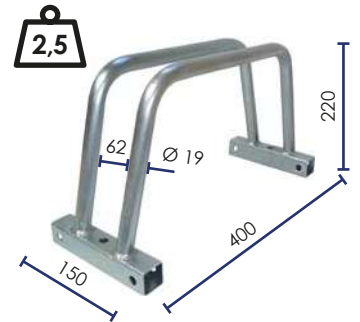

INCLUS ◦ INCLUDED ◦ INCLUIDO ◦ INKLUSIVE



### VELORACK

OPTION  
OPTIONAL  
OPCIÓN  
OPTIONAL



FSAFE 2 SB  
Ø 12 x 120

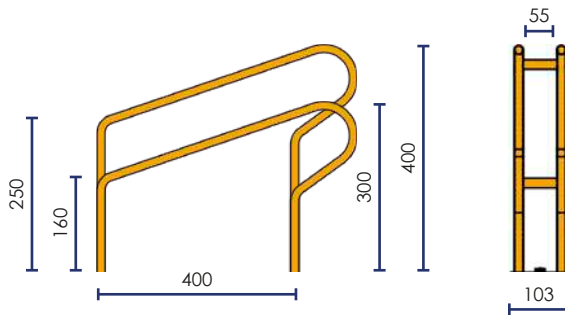

GALVA

VELORACK P

0,9

1,1

VELORACK G

### VELOSTORE

Code	
VELOSTORE	3

6



RAI 7037

PEINTURE ÉPOXY  
POWDER PAINTING  
PINTURA EPOXICA  
EPOXY FARBE

INCLUS  
INCLUDED ◦ INCLUIDO ◦ INKLUSIVE

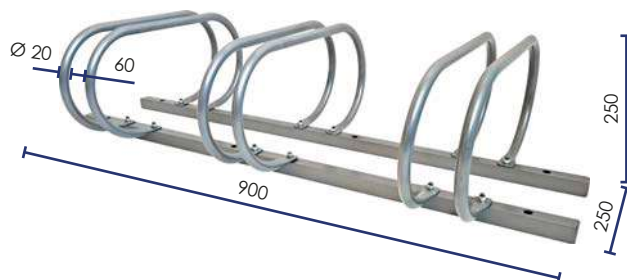





**VELOSTAND**

**VELO 5**

**RACK À VÉLO** ◦ **BICYCLE RACK** ◦ **APARCA BICICLETA** ◦ **FAHRRADSTÄNDER**

**VELO 755 GAL**

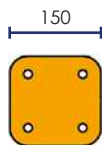
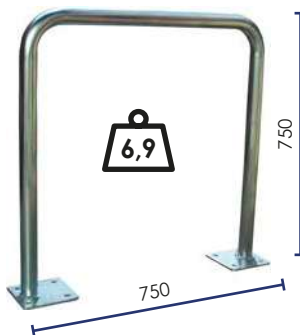
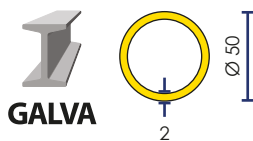

**POT 162 V \***

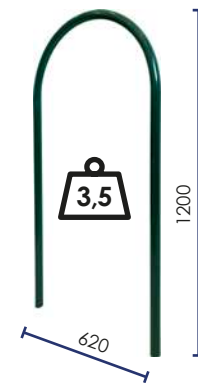
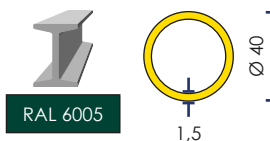

**VELO 5**



**INCLUS**  
INCLUDED ◦ INCLUIDO ◦ INKLUSIVE

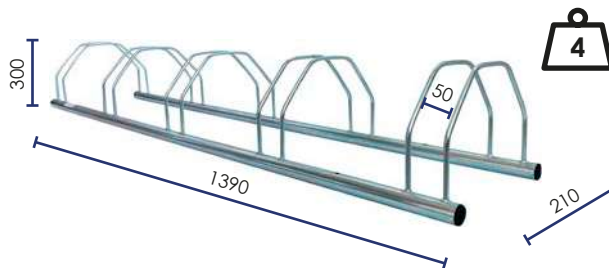
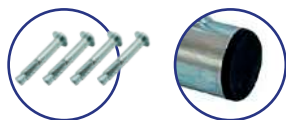

**VELOSTAND**

10 ≤  ≤ 14

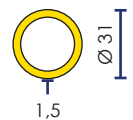
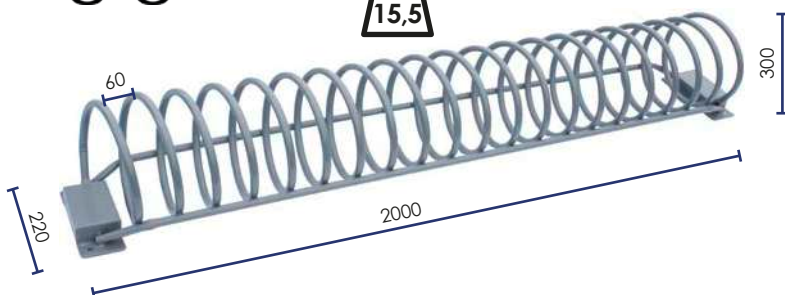

**OPTION**  
OPTIONAL  
OPCIÓN  
OPTIONAL



**FSAFE 4 SB**  
Ø 12 x 120



Ne pas installer en milieu salin ou Hydrocarbure. Nous consulter.  
Do not install in saline or Oil environment. Contact us.  
No lo instale en un ambiente salino o hidrocarburo. Consúltanos.  
Soll nicht in Salz oder Kohlenstoff Umgebung installiert werden, /uns Konsultieren.

Sauf ◦ Except ◦ Salvo ◦ Nur







VELORING



**RACK À TROTINETTE** ◦ **SCOOTER RACK**  
**APARCA PATINETES** ◦ **PARKSTÄNDER FÜR SCOOTER**



RAL 9005



PEINTURE ÉPOXY  
 POWDER PAINTING  
 PINTURA EPOXICA  
 EPOXY FARBE

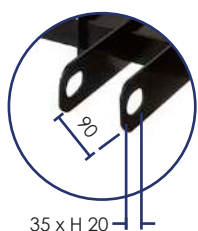
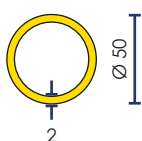

Bords arrondis  
 Rounded edges  
 Bordos redondeados  
 Abgerundete Ecken

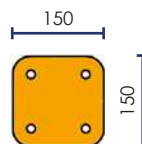
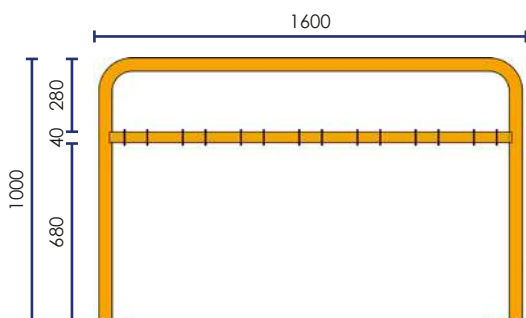

OPTION  
 OPTIONAL  
 OPCIÓN  
 OPTIONAL



BARFIX 8 SB  
 Ø 12 x 120

**ÉPINGLE À VÉLO** ◦ **U-SHAPED BIKE RACK**  
**HORQUILLA APARCA BICICLETA** ◦ **FAHRRADSTÄNDER**



RAL 9005



PEINTURE ÉPOXY  
 POWDER PAINTING  
 PINTURA EPOXICA  
 EPOXY FARBE

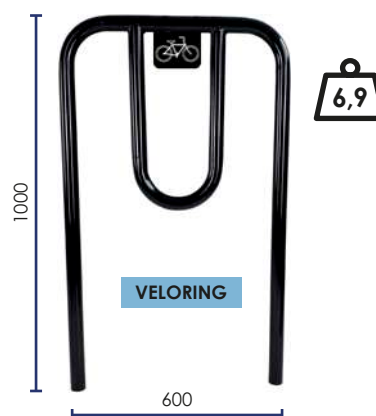
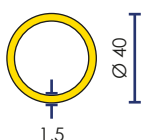

OPTION  
 OPTIONAL ◦ OPCIÓN ◦ OPTIONAL



BAS SOL



BBASE



Ne pas installer en milieu salin ou Hydrocarbure. Nous consulter.  
 Do not install in saline or Oil environment. Contact us.  
 No lo instale en un ambiente salino o hidrocarburo. Consúltanos.  
 Soll nicht in Salz oder Kohlenstoff Umgebung installiert werden, /uns Konsultieren.

Sauf ◦ Except ◦ Salvo ◦ Nur



GALVA



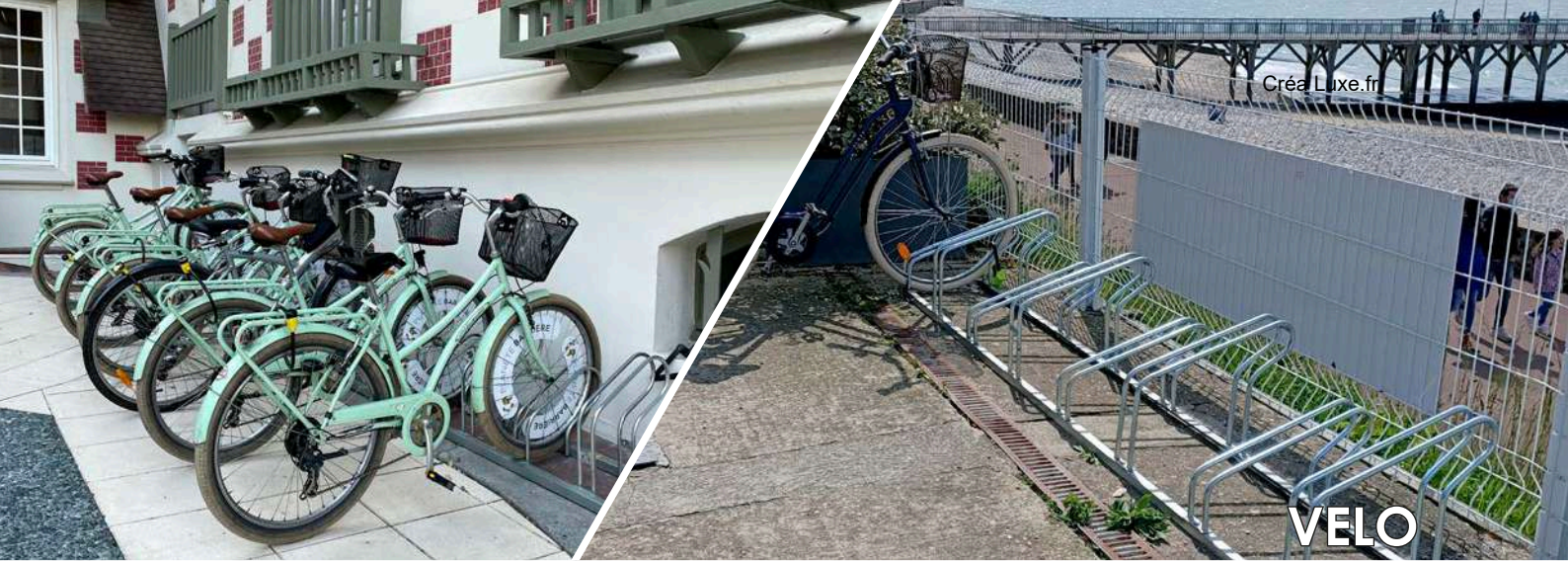

**VELO**

**RACK À VÉLO** ○ BICYCLE RACK  
**PARKING BICICLETA** ○ FAHRRADSTÄNDER



**FSAFE 4 SB**  
 Ø 12 x 120

- VELO 42 / 52 peuvent recevoir des vélos des 2 côtés.
- Fixations non incluses (4 x Ø 12 mm).

- VELO 42 / 52 can receive bicycles on both sides.
- Fixations are not included (4 x Ø 12 mm).

- VELO 42 / 52 pueden sostener bicicletas en ambos lados.
- Fijaciones no incluidas (4 x Ø 12 mm).

- VELO 42 / 52 kann von beiden Seiten Fahrräder aufnehmen.
- Ohne Bindungen (4 x Ø 12 mm).

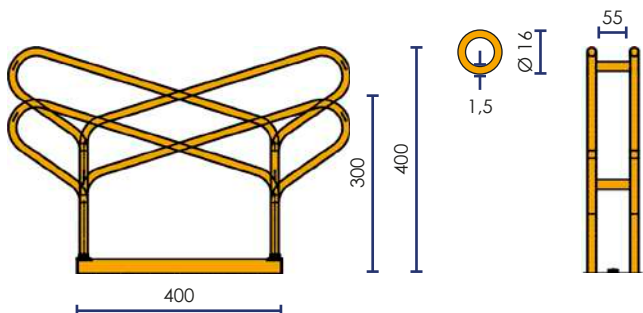
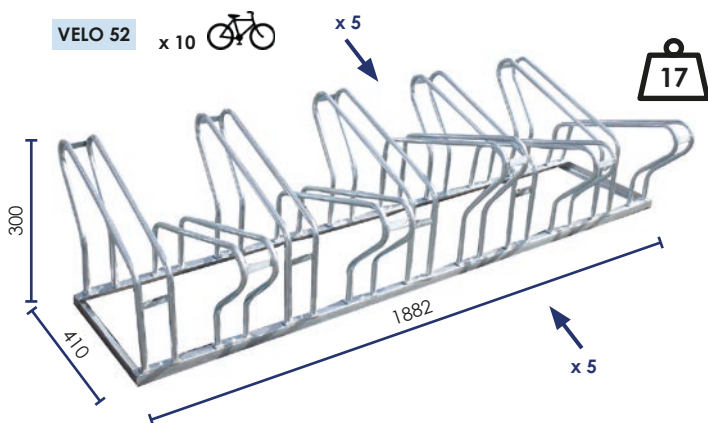
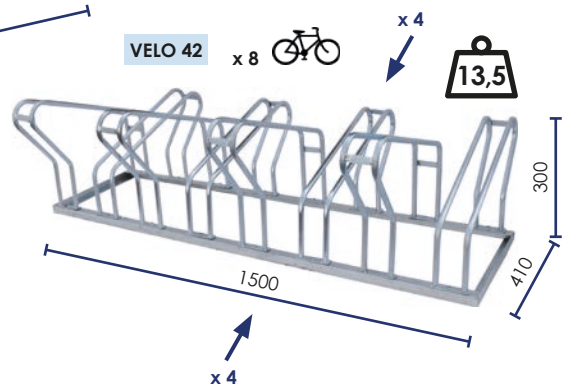
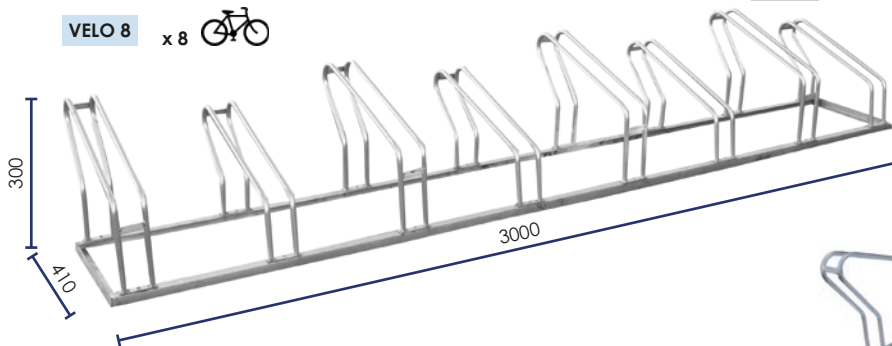
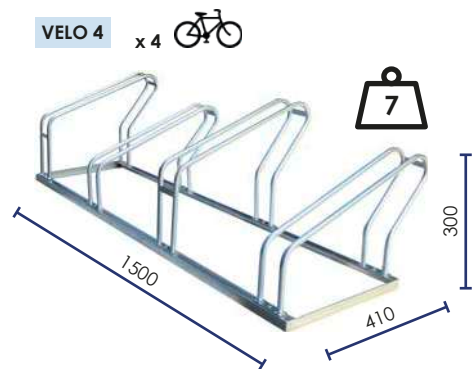
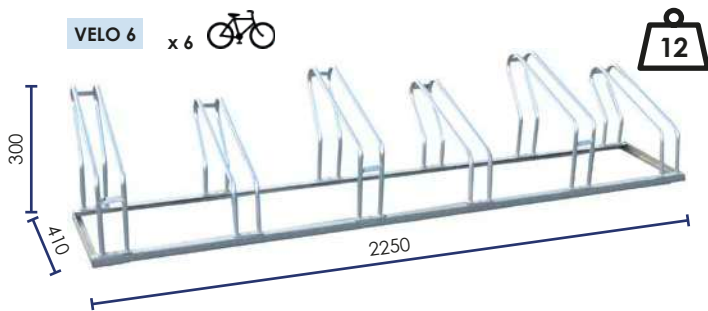





A series of horizontal blue lines for writing notes, starting from the top line below the pencil icon and extending to the bottom of the page.





## Chantier ◦ Construction





SERVIER

35

35

LVS VISO



## PROTÈGE CÂBLES ◦ CABLE COVERS

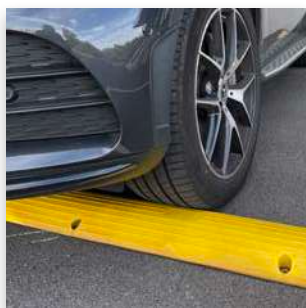
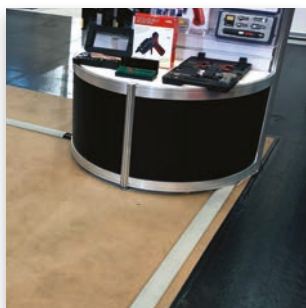

## CÔNES ◦ CONES

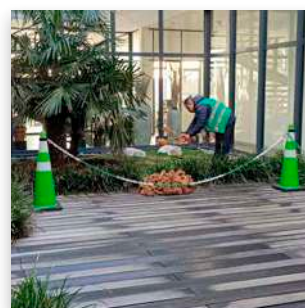

## RAMPE ◦ RAMPS

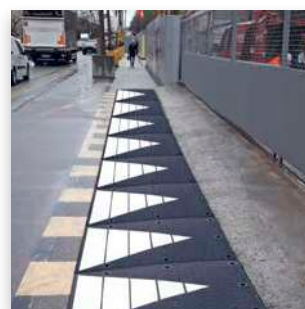

## BALISAGE ◦ SAFETY MARKING

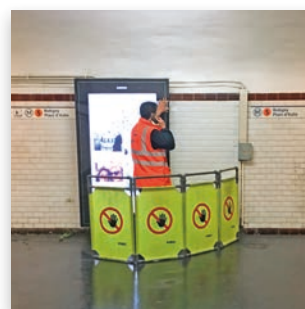





## PASSE-CÂBLES ◦ CABLES COVERS ◦ PROTECTOR DE CABLES ◦ KABELBRÜCKEN

CPB 702

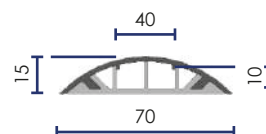
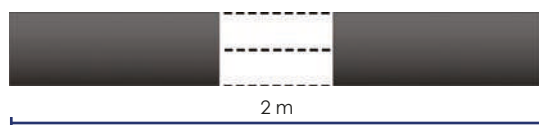

CPB 653

▶ 3 M

CPB 1023

CPB 655

▶ 5 M

CPB 1025

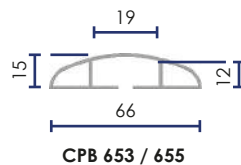

CPB 653 / 655

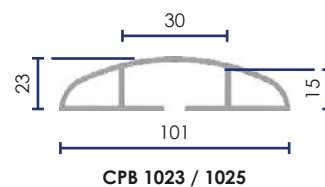

CPB 1023 / 1025

CP 5040

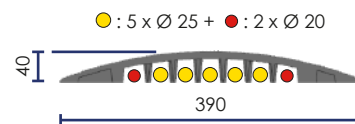
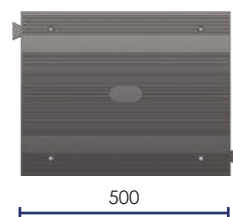

CP 202 / 402

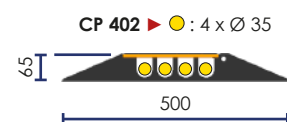
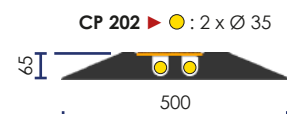

CP 1081

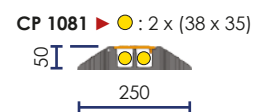
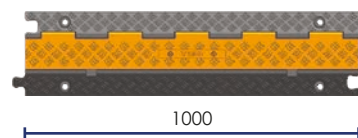

CP 1002 / 1031 / 1071

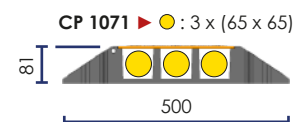
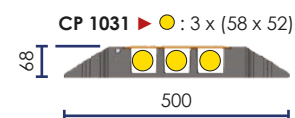
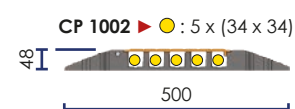
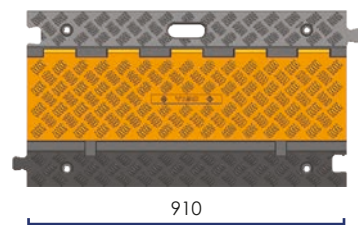

CPK 800 / 1100

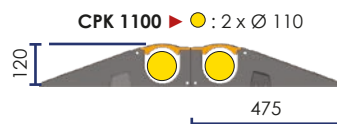
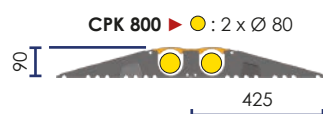





## PASSE-CÂBLES ◦ CABLES COVERS ◦ PROTECTOR DE CABLES ◦ KABELBRÜCKEN

CP 500 / 800 / 1200



CP 500 ▶ ● : 2 x Ø 50

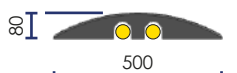

CP 800 ▶ ● : 2 x Ø 80

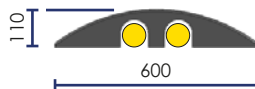

CP 1200 ▶ ● : 1 x Ø 120

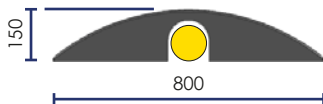

CPO 600 / 850 / 1000



CPO 600 ▶ ● : 2 x (75 x 80)

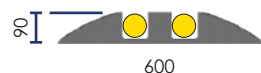

CPO 850 ▶ ● : 2 x (95 x 90)

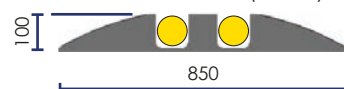

CPO 1000 ▶ ● : 2 x (135 x 120)

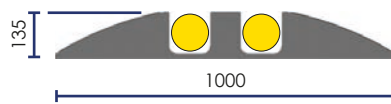

WP 100 ▶ 10 M

WP 170 ▶ 4 M



WP 100 ▶ ● : 1 x Ø 20

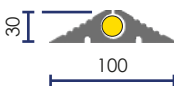

WP 170 ▶ ● : 1 x Ø 40

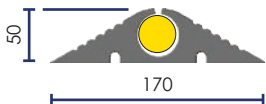

WP 240

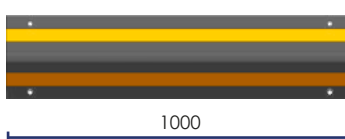

● : 1 x Ø 60

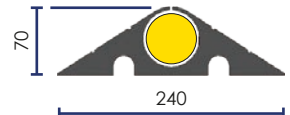

CP 450

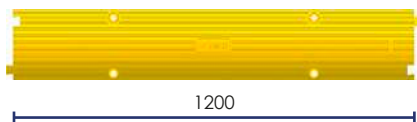

● : 1 x Ø 45 + ● : 2 x Ø 20

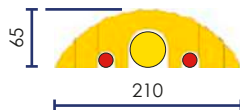

SAFETY 100



● : 2 x Ø 50

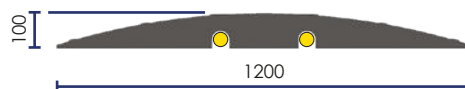

ZEBRA 65 / 100

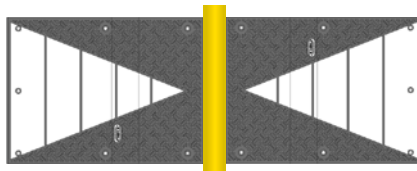

ZEBRA 65



ZEBRA 100







CPB

**PASSE CÂBLE DE BUREAU** ◦ FLOOR CABLE COVER  
**PROTECTOR DE CABLES** ◦ FUSSBODEN KABELBRÜCKE ◦ BODEN KABELBRÜCKE



**SOUPLE** ◦ FLEXIBLE ◦ FLEXIBLE ◦ WEICH

Code	↔	kg
CPB 653	3 m	1,40
CPB 655	5 m	2,20
CPB 1023	3 m	3,00
CPB 1025	5 m	4,90

- CPB 653 / 655 ▶ 19 x 12
- CPB 1023 / 1025 ▶ 30 x 15



- En rouleau
- Chargement par le dessous
- Découpe facile au cutter
- Livré avec adhésif double face

- In roll
- Bottom loading
- Easy to cut with a cutter
- Supplied with double-sided tape

- En rollo
- Cargando desde abajo
- Fácil de cortar con un cúter
- Se suministra con adhesivo de doble cara

- In Rollen
- Ladung vom Unten
- Einfaches Schneiden mit dem Cutter
- Geliefert mit doppelseitigem Klebstoff

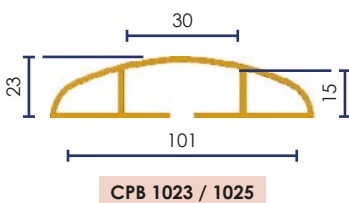
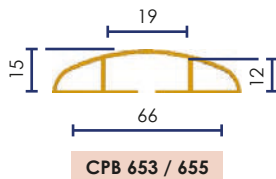

**INCLUS**  
**INCLUDED**  
**INCLUIDO**  
**INKLUSIVE**



**RIGIDE** ◦ RIGID ◦ RÍGIDO ◦ STARR

Code	↔	kg
CPB 702	2 m	1,00
CPB 70 T		0,05
CPB 70 L		0,05

- ▶ 2 x (17 x 10)

CPB 702



- Découpe possible à la longueur souhaitée
- Avec adhésif double face

- Can be cut to the desired length
- Supplied with double-sided tape

- Puede ser cortado a la longitud deseada
- Se suministra con adhesivo de doble cara

CPB 70 T



- Kann auf die Gewünschte Länge geschnitten werden
- Geliefert mit doppelseitigem Klebstoff

CPB 70 L



**INCLUS**  
**INCLUDED**  
**INCLUIDO**  
**INKLUSIVE**

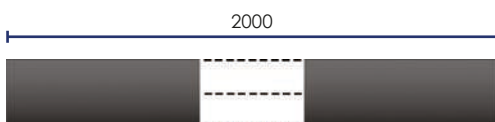
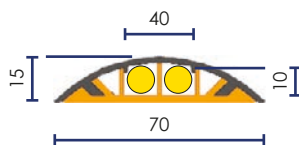
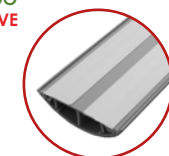





CP 5040

**PASSE CÂBLE PIÉTON** ○ **PEDESTRIAN CABLE COVER**

**PROTECTOR DE CABLES PEATONES** ○ **KABELBRÜCKE FÜR FUSSGÄNGERVERKEHR**

2 x Ø 20 + 5 x Ø 25

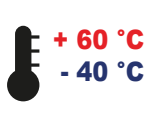

**INSTALLATION TEMPORAIRE** ○ **TEMPORARY USE** ○ **USO TEMPORARIO** ○ **VORÜBERGEHENDE NUTZUNG**

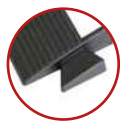
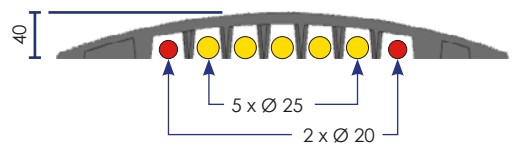
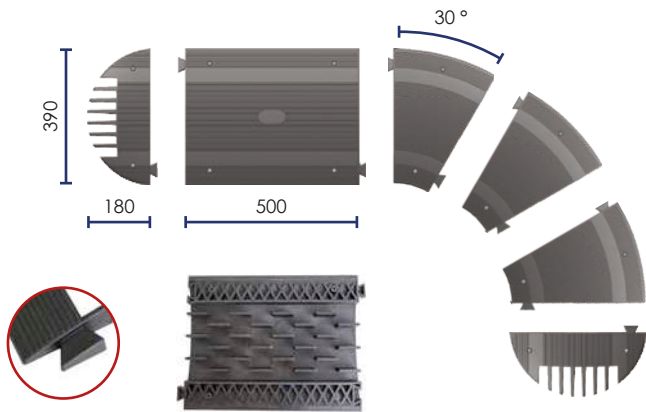

CP 5040



CPR 5040



CPE 5040



- Utilisation lors d'évènements en intérieur ou en extérieur dans les zones piétonnes (expositions, foires, etc.)
- Equipé d'emplacements pour mettre 2 bandes réfléchissantes classe 1 pour plus de sécurité
- To use at events both indoor and outdoor in pedestrian areas (exhibitions, fairs etc.)
- Equipped with space to put 2 class 1 reflective strips for more safety
- Para su uso en eventos tanto en el interior como en el exterior en zonas peatonales (exposiciones, ferias, etc.)
- Equipado con ranuras para poner 2 tiras reflectantes de clase 1 para mayor seguridad
- Einsatz bei Events im Innen- und Außenbereich in Fußgängerzonen (Ausstellungen, Messen, usw.)
- Ausgestattet mit Platzierung für 2 Reflektoren Streifen Klasse 1 für mehr Sicherheit

**INCLUS**  
INCLUDED ○ INCLUIDO ○ INKLUSIVE



A collar ○ To stick  
A pegar ○ Zu kleben

**OPTION**  
OPTIONAL ○ OPCIÓN ○ OPTIONAL



CP 5 FIX SB  
Ø 8 x 60





CP 5 SPIKE SB  
Ø 6 x 300





CP 202 / 402

**PASSE CÂBLE MODULAIRE** ◦ **MODULAR CABLE PROTECTOR**  
**PROTECTOR DE CABLES MODULAR** ◦ **KABELBRÜCKE MODULAR**

-  CP 202 ▶ 2 x Ø 35
-  CP 402 ▶ 4 x Ø 35









CAOUTCHOU  
RUBBER  
CAUCHO  
KAUTSCHUK





Couvercle  
Lid  
Tapa  
Deckel



OIL

**INSTALLATION TEMPORAIRE** ◦ **TEMPORARY USE** ◦ **USO TEMPORARIO** ◦ **VORÜBERGEHENDE NUTZUNG**

Code		
CP 202	4	9,0
CPR 202	3	9,5
CPE 202	2	4,0
CP 402	4	8,0
CPR 402	3	8,0
CPE 402	2	3,0

CP 202

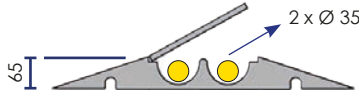

65

2 x Ø 35

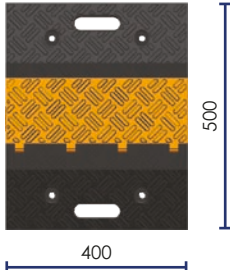

400

500



CP 202



CPE 202



CPR 202



30°



CP 402

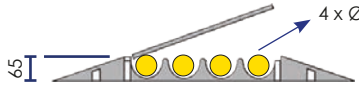

65

4 x Ø 35

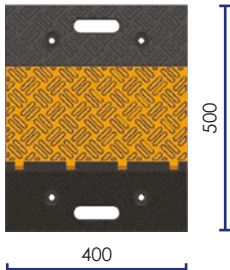

400

500



CP 402



CPE 402



CPR 402



30°



**OPTION** ◦ **OPTIONAL** ◦ **OPCIÓN** ◦ **OPTIONAL**

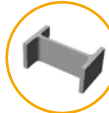

H de liaison pour connecter les éléments entre eux  
 H links for connecting the elements together  
 H de unión para conectar los elementos  
 H Verbindung zum Verbinden von Bauteilen



SPIKES  
Ø 12 x 300



FIX 4 SB  
Ø 12 x 130



RQ GLUE





Créa Luxe.fr

CPK 800 / 1100

# PASSE CÂBLE TRANSPORTABLE PLIANT

FOLDABLE CABLE PROTECTOR

PROTECTOR DE CABLES PLEGABLE ◦ KABELBRÜCKE TRAGBAR/FALTBAR

● CPK 800 ▶ 2 x Ø 80

● CPK 1100 ▶ 2 x Ø 110



CAOUTCHOUC VULCANISÉ  
VULCANIZED RUBBER  
CAUCHO VULCANIZADO  
VULKANISIERTEM KAUSCHUK



Couvercle  
Lid  
Tapa  
Deckel



INSTALLATION TEMPORAIRE ◦ TEMPORARY USE ◦ USO TEMPORARIO ◦ VORÜBERGEHENDE NUTZUNG

Code			
CPK 800	300 x 190 x 425	850 x 300 x 90	18,40
CPK 1100	300 x 240 x 475	950 x 300 x 120	25,00

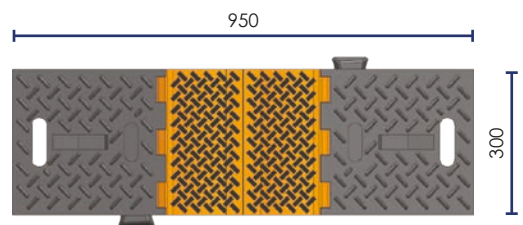
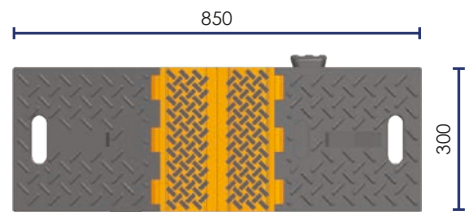
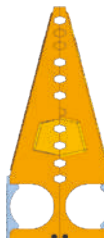
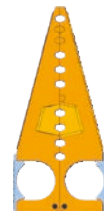
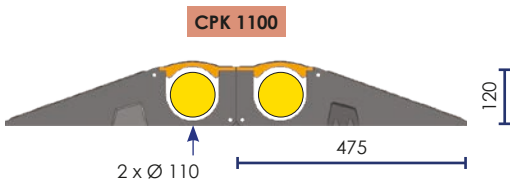
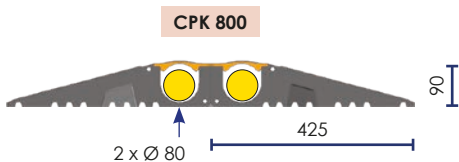

OPTION  
OPTIONAL ◦ OPCIÓN ◦ OPTIONAL

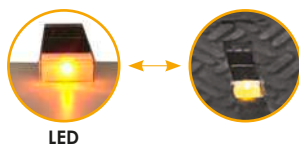





# CP 1000 SÉRIE

## PASSE CÂBLE ◦ CABLE BRIDGE ◦ PROTECTOR DE CABLES ◦ KABELBRÜCKE



CAOUTCHOUC  
RUBBER  
CAUCHO  
KAUSCHUK



Couvercle  
Lid  
Tapa  
Deckel



INSTALLATION TEMPORAIRE  
TEMPORARY USE  
USO TEMPORARIO  
VORÜBERGEHENDE NUTZUNG

### CP 1081

2 x (38 x 35)

Code	kg
CP 1081	9,0
CPR 1081	2,0
CPE 1081	1,0
CPS 1081	2,7

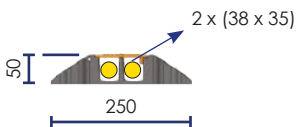
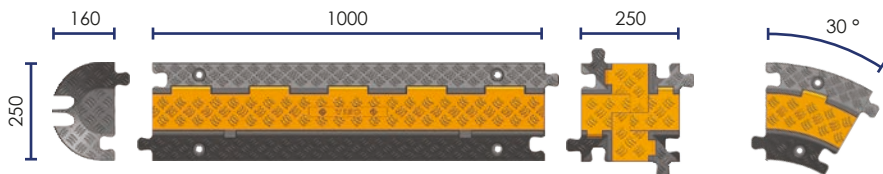

### CP 1002

5 x (34 x 34)

Code	kg
CP 1002	17,2
CPR 1002	5,0
CPE 1002	3,0
CPS 1002	10

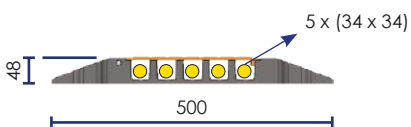
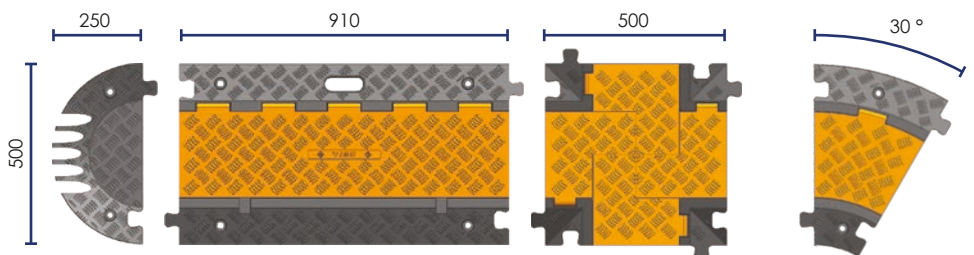

Poignée  
Handle  
Asa  
Handgriff

Trous de fixation  
Fixation holes  
Agujeros de fijación  
Befestigungslöcher

Assemblage  
Assembling  
Montaje  
Montage

Fermeture capot  
Lid closing  
Cierre tapa  
Deckel Verschlussung

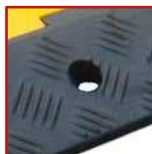

- ▶ CP 1002
- ▶ CP 1031
- ▶ CP 1071

### OPTION ◦ OPTIONAL ◦ OPCIÓN ◦ OPTIONAL



SPIKE 4 SB  
Ø 12 x 300



FIX 1 SB  
Ø 12 x 130



RQ GLUE





CP 1000 SÉRIE

PASSE CÂBLE ◦ CABLE BRIDGE ◦ PROTECTOR DE CABLES ◦ KABELBRÜCKE



CAOUTCHOUC  
RUBBER  
CAUCHO  
KAUSCHUK



Couvercle  
Lid  
Tapa  
Deckel



INSTALLATION TEMPORAIRE  
TEMPORARY USE  
USO TEMPORARIO  
VORÜBERGEHENDE NUTZUNG

CP 1031 3 x (58 x 52)

Code	kg
CP 1031	16,8
CPR 1031	4,6
CPE 1031	3,5
CPS 1031	13,0

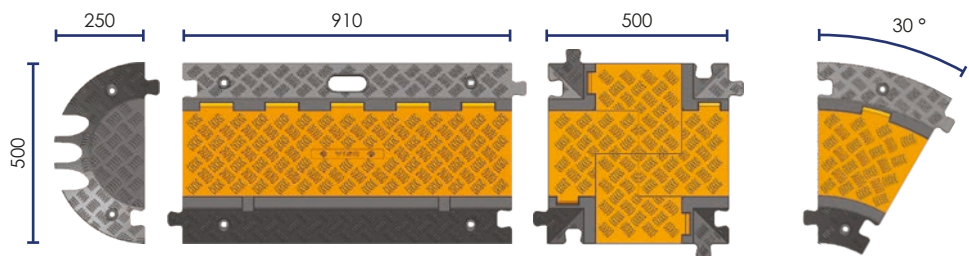
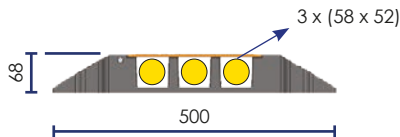

CP 1071 3 x (65 x 65)

Code	kg
CP 1071	23,0
CPR 1071	6,8
CPE 1071	4,5
CPS 1071	12,0

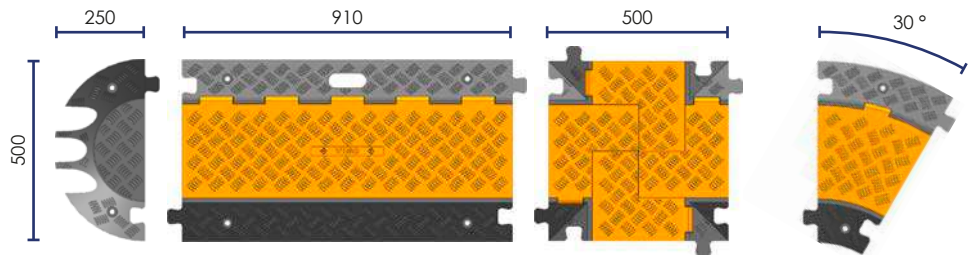
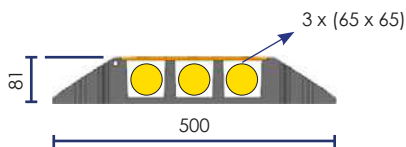

OPTION ◦ OPTIONAL ◦ OPCIÓN ◦ OPTIONAL

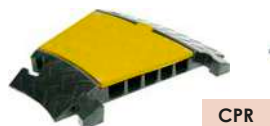





CPO

# PASSE CÂBLE ET TUYAUX POIDS LOURD

HOSE AND CABLE BRIDGE

PROTECTOR DE CABLE Y MANGUERA

KABELBRÜCKE UND SCHLÄUCHE FÜR LKW

- CPO 600 ▶ 2 x (75 x 80)
- CPO 850 ▶ 2 x (95 x 90)
- CPO 1000 ▶ 2 x (135 x 120)

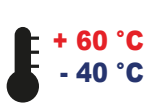

CAOUTCHOUC VULCANISÉ  
VULCANIZED RUBBER  
CAUCHO VULCANIZADO  
VULKANISIERTEM KAUSCHUK

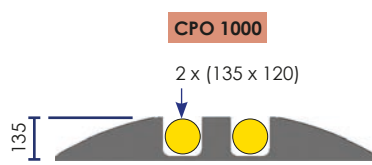
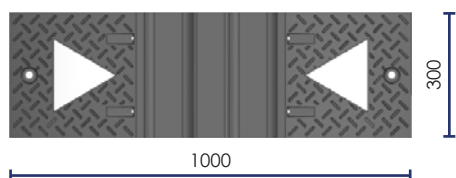
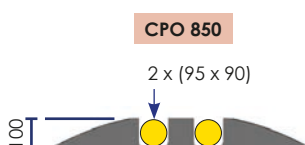
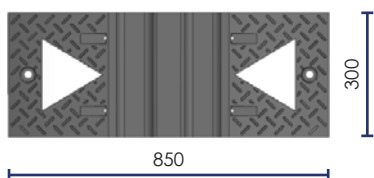
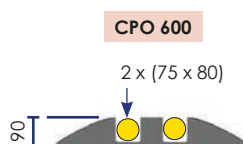
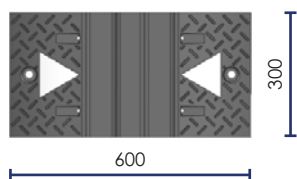

INCLUS ◦ INCLUDED ◦ INCLUIDO ◦ INKLUSIVE



x 4

OPTION ◦ OPTIONAL ◦ OPCIÓN ◦ OPTIONAL



GEY 1 SB

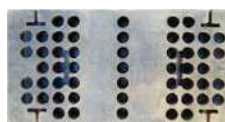

SPIKES  
Ø 12 x 300



FIX 1 SB  
Ø 12 x 130



RQ GLUE





CP

# PASSE CÂBLE ET TUYAUX POIDS LOURD

HOSE AND CABLE BRIDGE

PROTECTOR DE CABLE Y MANGUERA

LKW KABELBRÜCKE FÜR KABEL UND SCHLÄUCHE

- CP 500 ▶ 2 x Ø 50
- CP 800 ▶ 2 x Ø 80
- CP 1200 ▶ 1 x Ø 120



CAOUTCHOUC VULCANISÉ  
VULCANIZED RUBBER  
CAUCHO VULCANIZADO  
VULKANISIERTEM KAUSCHUK

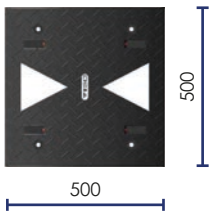

CP 500

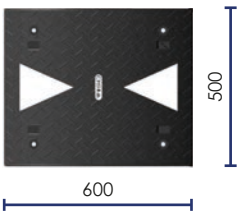
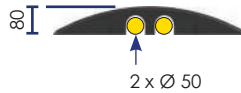

CP 800

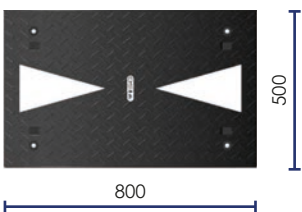
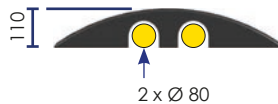

CP 1200

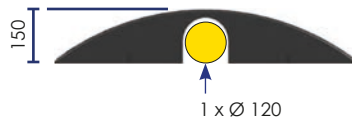

INCLUS ◦ INCLUDED ◦ INCLUIDO ◦ INKLUSIVE



x 4

OPTION ◦ OPTIONAL ◦ OPCIÓN ◦ OPTIONAL



GEY 1 SB

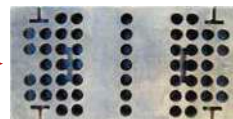

SPIKE 4 SB  
Ø 12 x 300



FIX 4 SB  
Ø 12 x 130



RQ GLUE





WP 100 / 170

WP 240

**PASSE CÂBLE CHANTIER** ◦ **WORKSITE CABLE PROTECTOR**  
**PROTECTOR DE CABLES PARA OBRAS** ◦ **KABELBRÜCKE FÜR BAUSTELLE**

-  WP 100 ▶ 1 x Ø 20
-  WP 170 ▶ 1 x Ø 40
-  WP 240 ▶ 1 x Ø 60



**+ 60 °C**  
**- 40 °C**

**CAOUTCHOUC VULCANISÉ**  
**VULCANIZED RUBBER**  
**CAUCHO VULCANIZADO**  
**VULKANISIERTEM KAUSCHUK**



**INSTALLATION TEMPORAIRE** ◦ **TEMPORARY USE** ◦ **USO TEMPORARIO** ◦ **VORÜBERGEHENDE NUTZUNG**

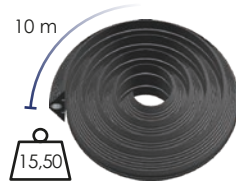

WP 100

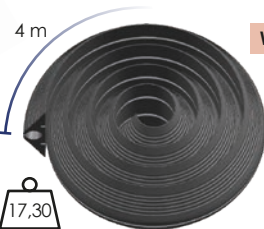
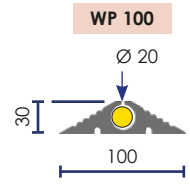

WP 170

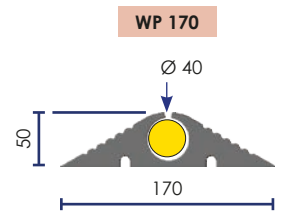

WP 240

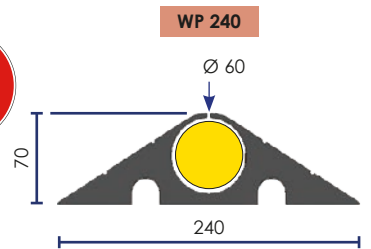

WPR 240

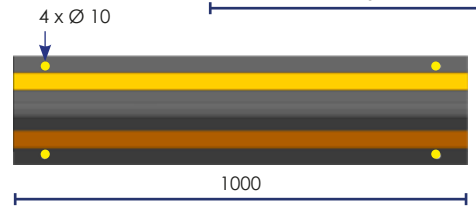

**INCLUS** ◦ **INCLUDED** ◦ **INCLUIDO** ◦ **INKLUSIVE**

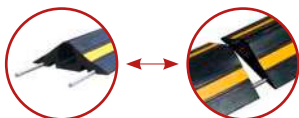

2 liaisons ◦ 2 links  
 2 Elementos de unión  
 2 Verbindungen  
**WP 240**



Trous de fixation ◦ Fixation holes  
 Agujeros de fijación  
 Befestigungslöcher  
**WP 240**

**OPTION** ◦ **OPTIONAL** ◦ **OPCIÓN** ◦ **OPTIONAL**



**SPIKE WP 244 SB**  
**WP 240**



**FIX WP 244 SB**  
**WP 240**



**RQ GLUE**





SAFETY 100

CP 450

**PASSE CÂBLE GRANDE LONGUEUR** ◦ **EXTRA LONG CABLE BRIDGE**  
**PROTECTOR DE CABLE EXTRA LARGO** ◦ **KABELBRÜCKE MIT GROSSER LÄNGER**

1 x Ø 45 + 2 x Ø 20

CAOUTCHOUC VULCANISÉ  
 VULCANIZED RUBBER  
 CAUCHO VULCANIZADO  
 VULKANISIERTEM KAUSCHUK



CP 450 JA



x 4 trous de fixation  
 Fixation holes  
 Agujeros de fijación  
 Befestigungslöcher

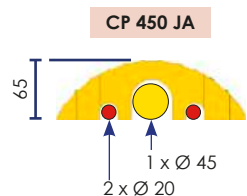

CP 450 JA

OPTION ◦ OPTIONAL ◦ OPCIÓN ◦ OPTIONAL



SPIKE 4 SB  
 Ø 12 x 300



FIX 4 SB  
 Ø 12 x 130



RQ GLUE

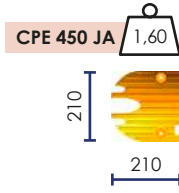

CPE 450 JA

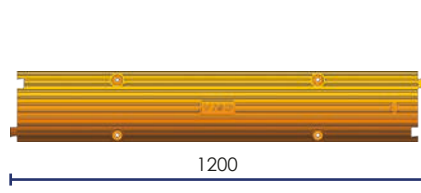

CPR 450 JA

**PASSE CÂBLE TRAVERSÉE DE ROUTE** ◦ **ROAD CROSSING CABLE BRIDGE**  
**PROTECTOR DE CABLES PARA CARRETERA** ◦ **KABELBRÜCKE FÜR STRASSE ÜBERQUERUNG**

2 x Ø 50

CAOUTCHOUC VULCANISÉ  
 VULCANIZED RUBBER  
 CAUCHO VULCANIZADO  
 VULKANISIERTEM KAUSCHUK



SCUP 100 N

SAFETY 100 NJ

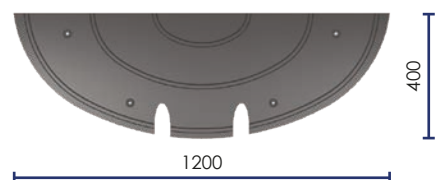
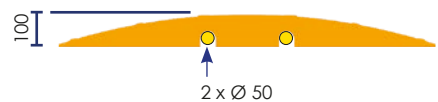

INCLUS ◦ INCLUDED  
 INCLUIDO ◦ INKLUSIVE



x 2



x 4 trous de fixation  
 Fixation holes  
 Agujeros de fijación  
 Befestigungslöcher

OPTION ◦ OPTIONAL ◦ OPCIÓN ◦ OPTIONAL



SPIKE 4 SB  
 Ø 12 x 300



FSAFE 4 SB  
 Ø 12 x 120



RQ GLUE





ZEBRA 65



ZEBRA 100

**PASSE CÂBLE TRAVERSÉE DE ROUTE** ◦ **ROAD CROSSING CABLE PROTECTOR**  
**PROTECTOR DE CABLES PARA CARRETERA** ◦ **KABELBRÜCKE FÜR STRASSE ÜBERQUERUNG**

**ZEBRA 65**

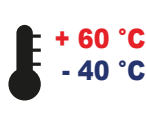

Code	Ø Câble	Largeur route ◦ Road width Ancho de carretera ◦ Breite	kg
<b>H 65 mm - Rouge ◦ Red ◦ Rojo ◦ Rot</b>			
CP 2265	65	2,16	264
CP 2765		2,70	330
CP 3265		3,24	396
CP 3865		3,78	462
CP 4365		4,32	528
CP 4865		4,86	594
CP 5465		5,40	660
CP 5965		5,94	726

Ø 65 – 80

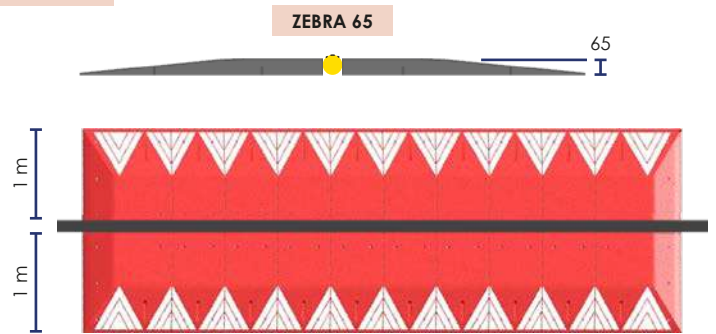

Noir : nous consulter. ◦ Black : ask us. ◦ Negro : consultarnos. ◦ Schwarz : Kontaktieren Sie uns.

**ZEBRA 100**

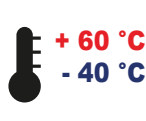

Code	Ø Câble	Largeur route ◦ Road width Ancho de carretera ◦ Breite	kg
<b>H 100 mm - Noir ◦ Black ◦ Negro ◦ Schwarz</b>			
CP 22100	100	2,25	375
CP 30100		3,00	500
CP 38100		3,75	625
CP 45100		4,50	750
CP 53100		5,25	875
CP 60100		6,00	1000

Ø 100 – 120

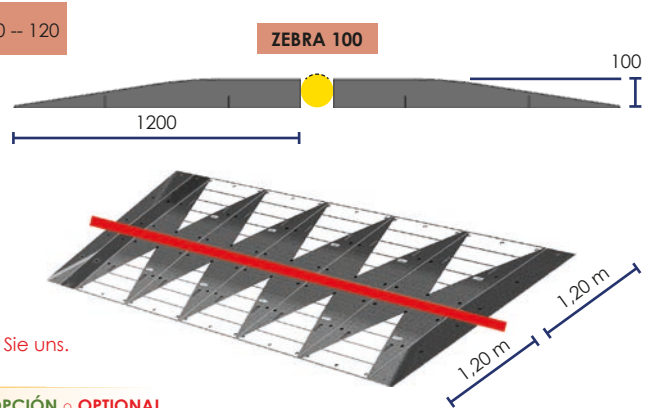

Rouge : nous consulter. ◦ Red : ask us. ◦ Rojo : consultarnos. ◦ Rot : Kontaktieren Sie uns.

**INCLUS ◦ INCLUDED ◦ INCLUIDO ◦ INKLUSIVE**



**OPTION ◦ OPTIONAL ◦ OPCIÓN ◦ OPTIONAL**

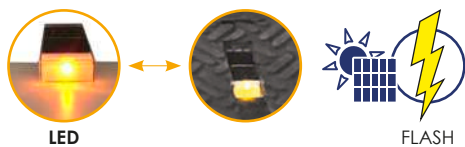









SSC 310 / 370



CSL 700

## CÔNE DE SIGNALISATION PLIANT

FOLDABLE REFLECTIVE CONE ◦ CONO PLEGABLE CON LUZ ◦ FALTLITKEGEL



2 x LR03\*



1 x CR2032\*



Classe 2

\* Piles non fournies ◦ Batteries not supplied  
Baterías no incluidas ◦ Batterien nicht enthalten

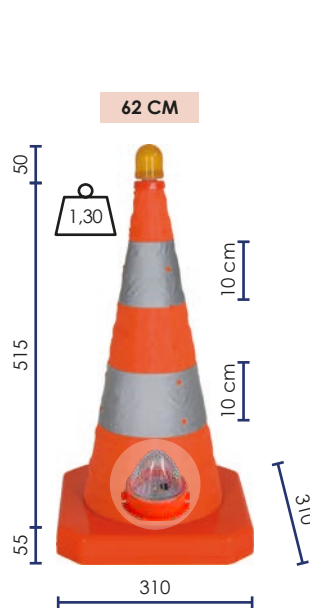

SSC 310

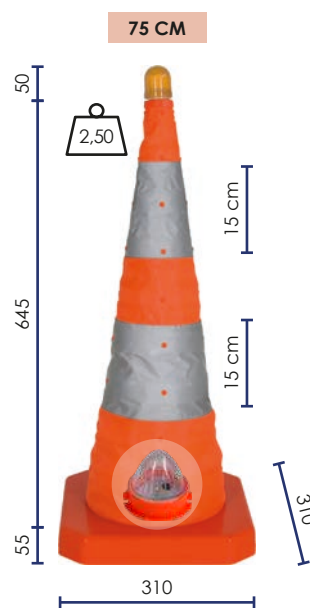

SSC 370

## BALISE DE RUE

BLACK CUSTOMIZABLE CONE ◦ BALIZA ◦ STRASSEN LEITBAKE



Classe 1  
Class 1  
Clase 1  
Klasse 1



Réfléchissant  
Reflective  
Reflectante  
Reflektierende



50 x 20



Personnalisation : mini 100  
Customization mini 100  
Personalización mini 100  
Personalisierung : Mini 100

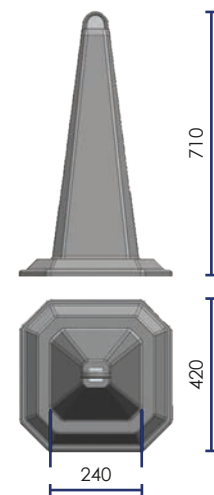





RC **CLASSE 2**

**CLASSE 1** CSC

## CÔNE RÉFLÉCHISSANT CLASSE 1

TRAFFIC CONE ◦ CONO DE SEÑALIZACIÓN ◦ REFLEKTIERENDER LEITKEGEL



Bandes réfléchissantes classe 1  
Reflective tape class 1  
Bandas reflectantes clase 1  
Reflektierende Streifen Klasse 1



CSC 301 : Ø 45 mm  
CSC 501 : Ø 45 mm  
CSC 751 : Ø 31 mm

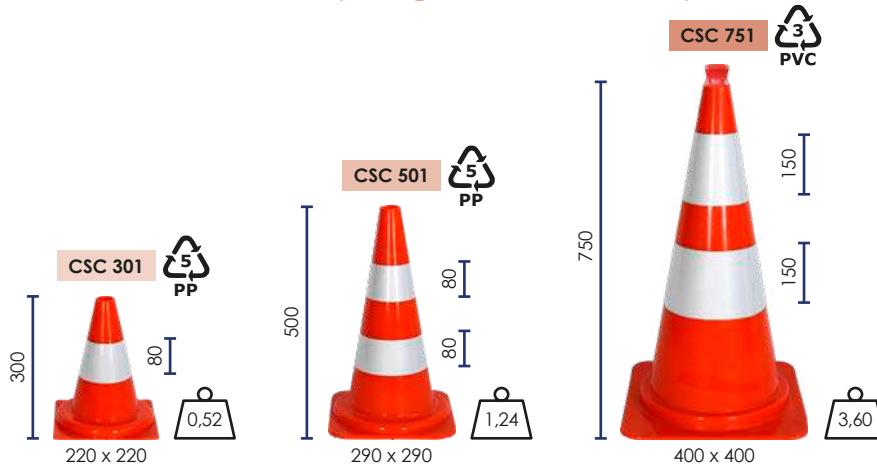

RC TROLLEY  
▶ p. 96

## CÔNE LESTÉ CLASSE 2. EN 13422

HEAVY DUTY CONE ◦ CONO CON BASE CAUCHO ◦ LEITKEGEL - STANDFUSS SCHWER



Base  
Base  
Base  
Standfuß

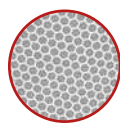

Bandes réfléchissantes classe 2  
Reflective tape class 2  
Bandas reflectantes clase 2  
Reflektierende Streifen Klasse 2



300 m



RC 300 : Ø 28 mm  
RC 500 : Ø 30 mm  
RC 752 : Ø 39 mm  
RC 1000 : Ø 39 mm

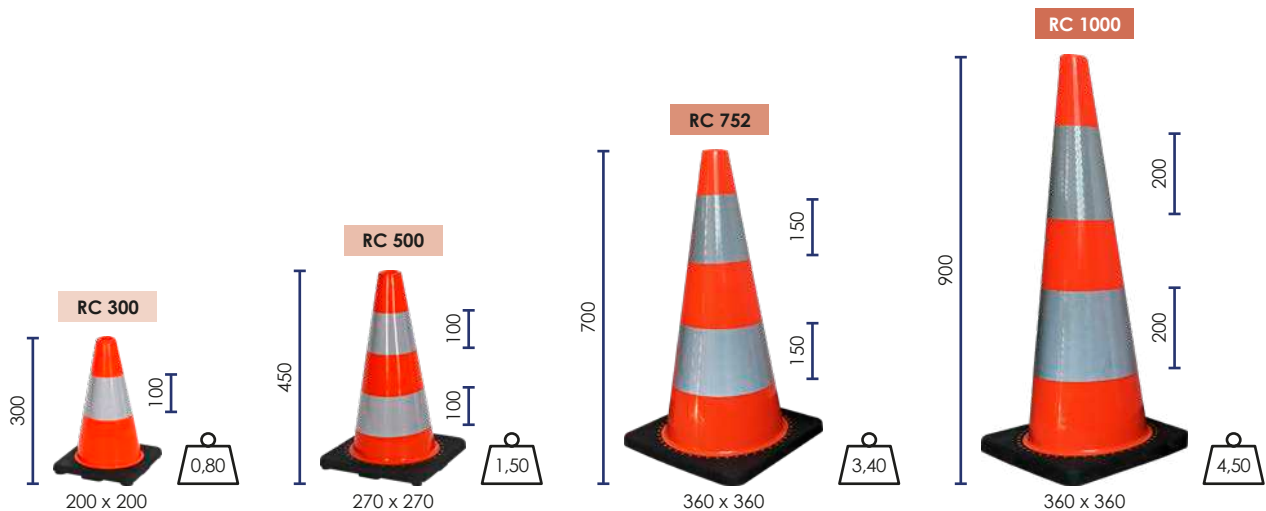



**HAUTEUR** ◦ HEIGHT ◦ ALTURA ◦ HÖHE



**70 CM**

**90 CM**

**COULEUR** ◦ COLOR ◦ COLOR ◦ FARBE



Choix des couleurs uniquement pour les cônes 90 cm  
Color's choice only for 90 cm cones  
Elección de colores solamente para conos de 90 cm  
Farbwahl nur für Leitkegel 90 cm



Base  
Base  
Base  
Standfuß



Ø 39 mm



PVC souple  
Flexible PVC  
PVC flexible  
Flexibel PVC



Base caoutchouc  
360 x 360 mm  
Rubber base  
Base de caucho  
Gummi Standfuß

Réfléchissant  
Reflective  
Reflexivo  
Reflektierend

**CLASSE 2. EN 13422**



Base caoutchouc  
Rubber base  
Base de caucho  
Gummi Standfuß



Base vide à lester  
550 x 550 mm  
Empty base to be loaded  
Base de lastre vacía

Leerer Sockel zum beschweren

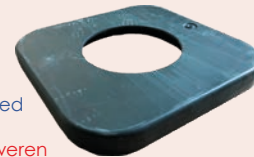

**3. COLORIS DE SANGLE** ◦ BELT COLOR ◦ COLOR DE CINTA ◦ FARBE DES GURTES

**2 M X 50 MM**  
**4 M X 50 MM**



**10 M X 50 MM**  
**4 M X 100 MM**  
**10 M X 100 MM**



▲ Sangle personnalisée (sauf 10 m), nous consulter.  
Customized belt (except 10 m), consult us.  
Cinta personalizada (salvo 10 m), consultarnos.  
Gurt Personalisierung (außer 10 m), uns konsultieren.





## ENROULEURS

RETRACTABLE BELT BARRIER ◦ ENROLLADOR DE CINTA ◦ ABSPERRGURT

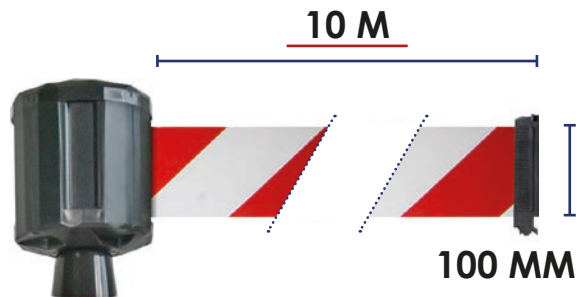
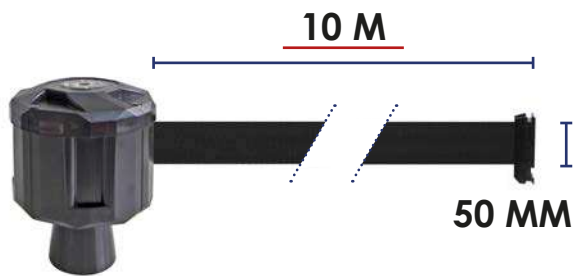
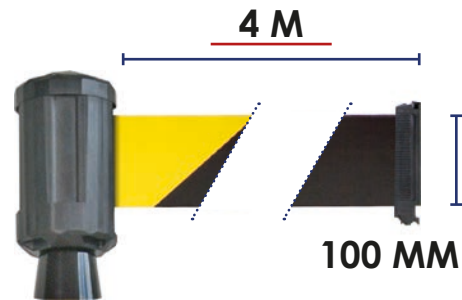
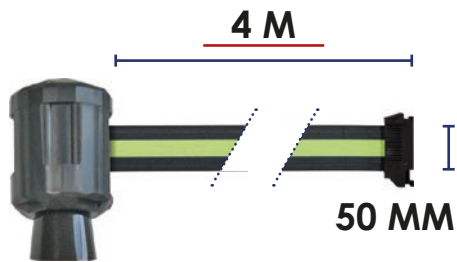
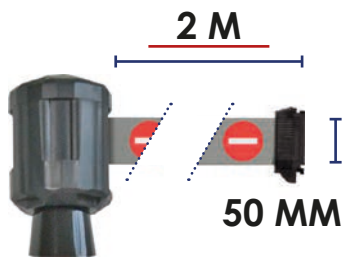

## 4. OPTIONS ◦ OPTIONS ◦ OPCIONES ◦ OPTIONEN

### BOITIER RÉCEPTEUR VIDE

EMPTY RECEIVER BOX  
CAJA RECEPTORA SIN CINTA  
LEERES EMPFANGSBOX



### PANNEAUX A3 ET A4

A3 AND A4 PANELS  
PANELES A3 Y A4  
PANEEL A3 UND A4



## STICKERS ◦ STICKERS ◦ ADHESIVOS ◦ AUFKLEBER





CLASSE 2. EN 13422



Cône ○ Cone  
Cono ○ Leitkegel

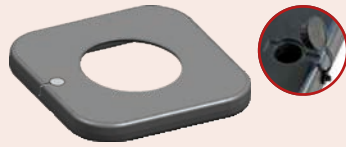

Base vide à lester  
550 x 550 mm  
Empty base to be loaded  
Base de lastre vacia  
Leerer Standfuß zu beschweren



Adaptateur  
Connector  
Adaptador  
Adapter



Enrouleur  
Retractable barrier  
Enrollador de cinta  
Abspergurt

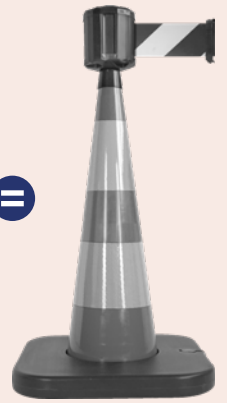

85 CM

Longueur sangle  
Belt length  
Largo de cinta  
Gurtlänge



85 cm

2 M

RCX72RE

RCX72RB

RCX72ENT

50 MM

4 M

RCX74RE

RCX74RB

RCX74ENT

10 M

RCX105RE

RCX105RB

90 CM



90 cm

4 M

RCX741RE

RCX741RB

100 MM

10 M

RCX110RE

RCX110RB

CLASSE 2. EN 13422

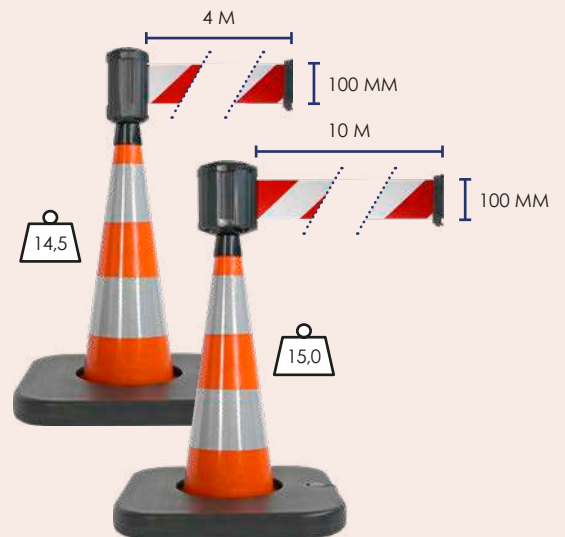
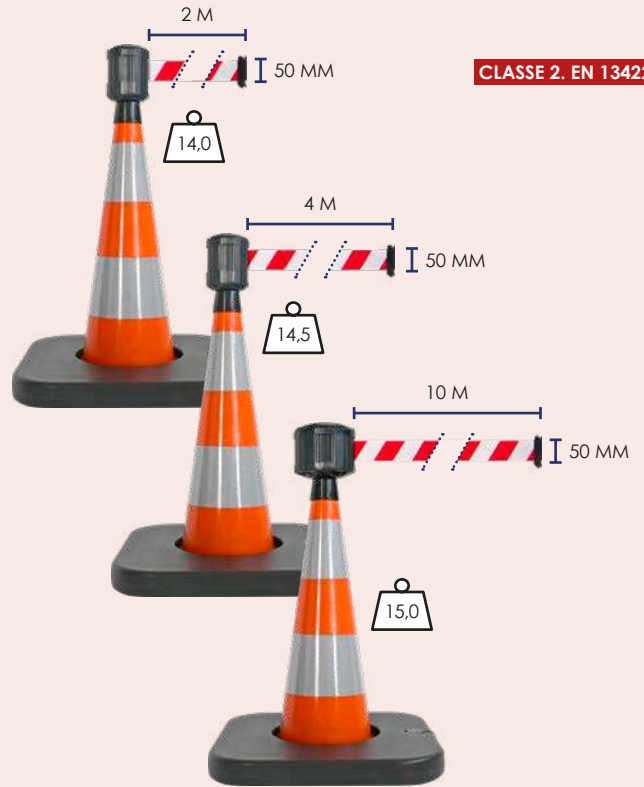





105 CM

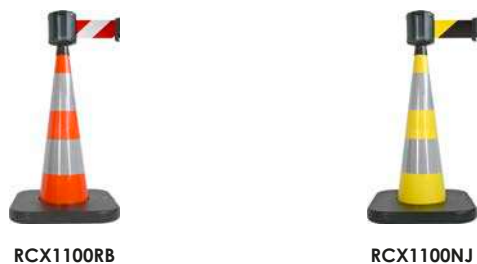
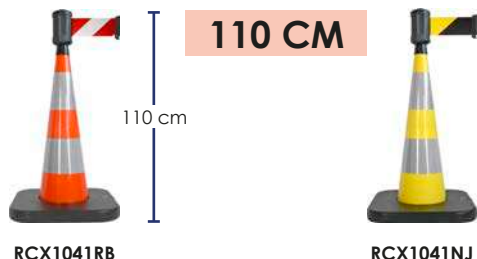
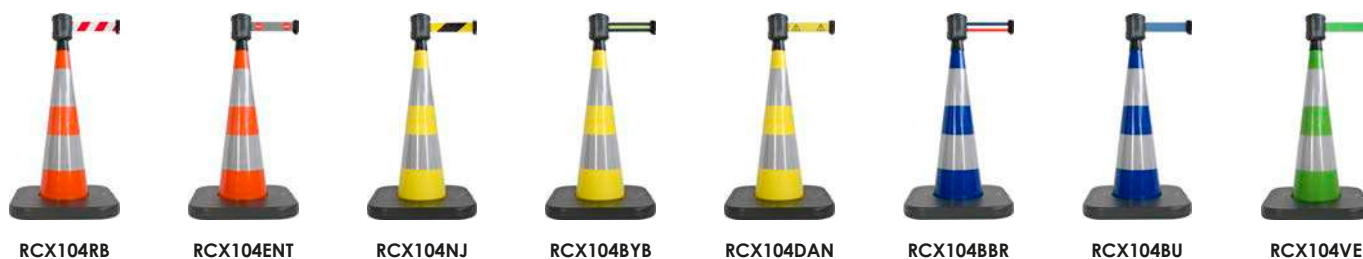





**BOITIER RÉCEPTEUR VIDE UNIVERSEL\***

EMPTY RECEIVER BOX ◦ CAJA RECEPTORA SIN CINTA ◦ LEERE EMPFANGSBX

Code	Pour ◦ For Para ◦ Für
RCBOX VID 24	RCX 2 / RCX 4
RCBOX VID 410	RCX 410
RCBOX VID 105	RCX 1050
RCBOX VID 110	RCX 1100



Peut recevoir jusqu'à 3 sangles ◦ Can receive up to 3 belts  
Puede recibir hasta 3 cintas ◦ Kann bis zu 3 Gurte aufnehmen



**ENROULEUR UNIVERSEL\***

UNIVERSAL RETRACTABLE BARRIER ◦ ENROLLADOR DE CINTA ◦ UNIVERSELL ABSPERRGURT

**2 M X 50 MM**

RCBOXBK2	●	RCBOXRB2	◐
RCBOXRE2	●	RCBOXNJ2	◑
RCBOXBU2	●	RCBOXBY2	◒
RCBOXGR2	●	RCBOXENT2	◓
RCBOXJA2	●	RCBOXDAN2	◔
RCBOXVE2	●	RCBOXBBR2	◕
RCBOXSTOP2	STOP ◐ STOP	RCBOXSECOURS2	ISSUE DE SECOURS

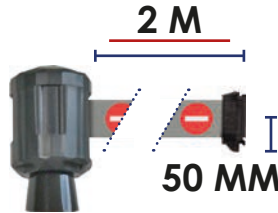

RCUNIVERSAL  
Adaptateur  
Connector  
Adaptador  
Adapter



**4 M X 50 MM**

RCBOXBK4	●	RCBOXRB4	◐
RCBOXRE4	●	RCBOXNJ4	◑
RCBOXBU4	●	RCBOXBY4	◒
RCBOXGR4	●	RCBOXENT4	◓
RCBOXJA4	●	RCBOXDAN4	◔
RCBOXVE4	●	RCBOXBBR4	◕
RCBOXSTOP2	STOP ◐ STOP	RCBOXSECOURS2	ISSUE DE SECOURS

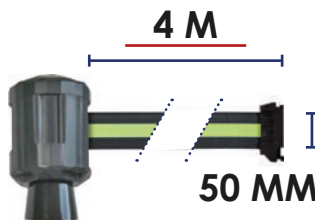

**4 M X 100 MM**

RCBOXBK410	●
RCBOXRE410	●
RCBOXRB410	◐
RCBOXNJ410	◑

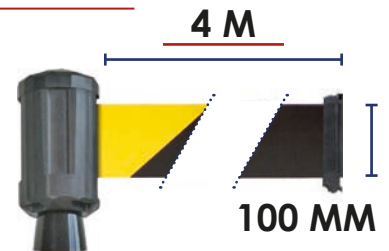

**10 M X 50 MM**

RCBOXBK105	●
RCBOXRE105	●
RCBOXRB105	◐
RCBOXNJ105	◑

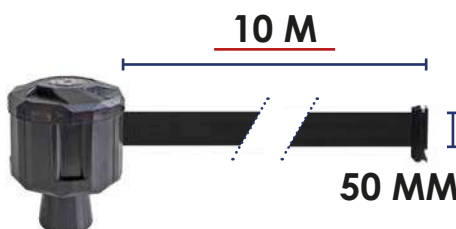

**10 M X 100 MM**

RCBOXBK110	●
RCBOXRE110	●
RCBOXRB110	◐
RCBOXNJ110	◑

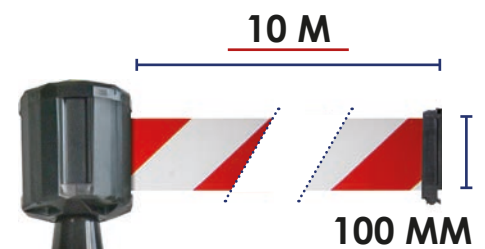

\* Compatible tous cônes ◦ Compatible with all cones ◦ Compatible con todos los conos ◦ Kompatibel mit allen Kegeln  
Récepteur mural ▶ p. 222 ◦ Wall receiver ▶ p. 222 ◦ Receptor mural ▶ p. 222 ◦ Wandempfänger ▶ p. 222



## AFFICHAGE ◦ SIGN BOARD ◦ PORTA CARTEL ◦ INFOTAFEL



Code
RCPNX A4
RCPNX A3

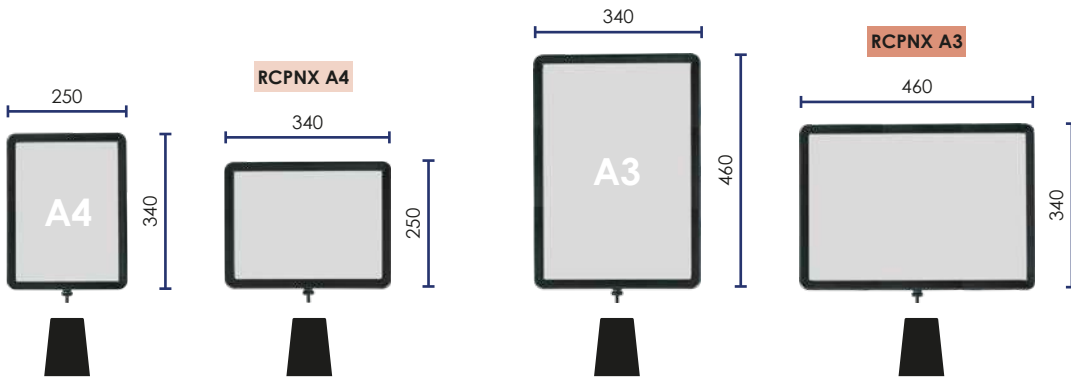
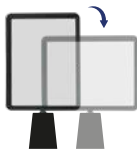

## BASE ◦ BASES ◦ BASES ◦ STANDFUß

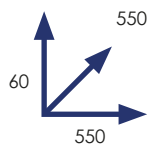

Base lestée béton  
Concrete loaded base  
Base lastrada con hormigón  
Beton beschwertem standfuß



Base vide à lester  
Empty base to be loaded  
Base de lastre vacía  
Leerer standfuß zum beschweren



RCBASE LO



RCBASE VD



## STICKER ◦ STICKERS ◦ ADHESIVOS ◦ AUFKLEBER

Lot de 2 stickers 210 x 210 mm  
Set of 2 stickers  
Lote de 2 adhesivos  
Set von 2 Stickern



STICKINTERDIT



STICKCHUTE



STICKNOPARK



STICKTEXT1

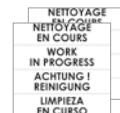

STICKTEXT2



STICKNOPIETON



STICKCHANTIER



STICKDANGER



STICKELECT



STICKNOPASS





**RC LAMPSOL 180**

► RC 752 / 1000



**FLASH 90**

► RC 752 / 1000



**RC 101 FLASH**

► RC 752 / 1000



RC 101 FLASH x 1

RC 106 FLASH x 6

**RC TROLLEY**



10 / 20 Cônes suivant modèle ◦ 10 / 20 depending on the type ◦ 10 / 20 conos según modelo ◦ Leikegel nach Modell

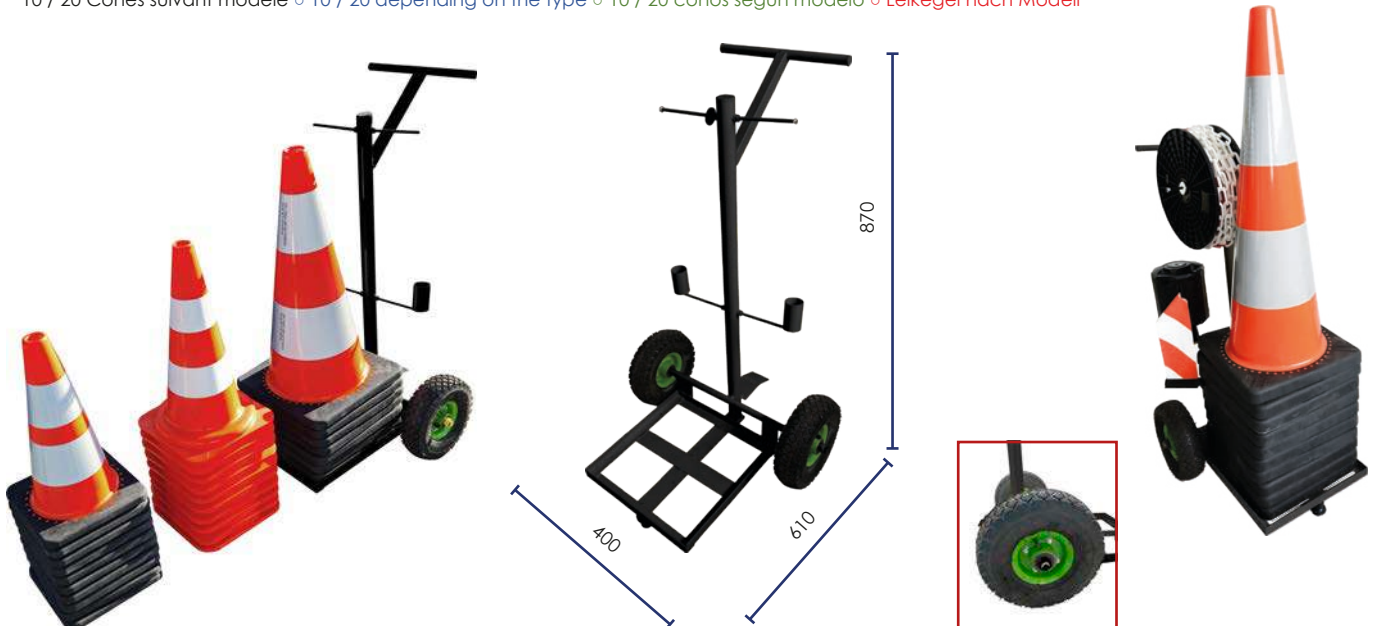



## BARRES EXTENSIBLES ◦ EXPANDING BARRIERS ◦ BARRAS EXTENSIBLES ◦ TELESKOPSTANGE

Compatible tous cônes

Compatible with all cones ◦ Compatible con todos los conos ◦ Kompatibel mit allen Kegeln

Code	
RC BAR215 RB	
RC BAR215 NJ	
RC BAR215 BU	
RC BAR215 VE	



Bandes réfléchissantes classe 1  
Reflective tape class 1  
Bandas reflectantes clase 1  
Reflektierende Streifen Klasse 1

Verrouillage à la longueur désirée  
Blocking device at chosen length  
Bloqueo a la longitud elegida  
Sperrvorrichtung in gewählter Länge



## BARRES ◦ BARRIERS ◦ BARRAS ◦ PLANKEN

Compatible tous cônes

Compatible with all cones ◦ Compatible con todos los conos ◦ Kompatibel mit allen Kegeln

**EXTENSIBLES**  
EXPANDABLE  
EXTENSIBLE  
TELESKOPISCH

Bandes réfléchissantes classe 1  
Reflective tape class 1  
Bandas reflectantes clase 1  
Reflektierende Streifen Klasse 1

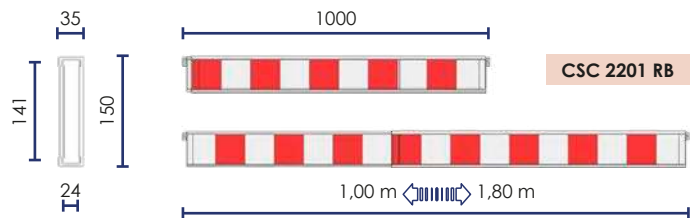

## CHAÎNES ◦ CHAINS ◦ CADENAS ◦ KETTEN

Compatible tous cônes

Compatible with all cones ◦ Compatible con todos los conos ◦ Kompatibel mit allen Kegeln

Code		
CBR 801 SBS		25 m x Ø 8
CNJ 801 SBS		
CBB 801 SBS		
CBV 801 SBS		



Code
CS RING 5 SB



x 5





PRESSING

ROY  
CHOCOLATIER

CLAW  
THANKS  
ZAPATAS

ROY CHOCOLATIER





RR

ZE

# RAMPES

RAMPS ◦ RAMPAS ◦ BORDSTEIN-RAMPEN



CAOUTCHOUC VULCANISÉ  
VULCANIZED RUBBER  
CAUCHO VULCANIZADO  
VULKANISIERTEM KAUSCHUK



## RR

Code	H	I	kg	
RR 35	35	300	6,50	4
RR 100	100	300	12,00	4
RR 150	150	360	19,00	4
RR 200	200	450	32,00	4
RRD 35	35	300	2,00	2
RRD 100	100	300	4,00	2
RRD 150	150	360	8,00	2
RRD 200	200	450	17,00	2

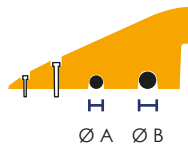

Code	Ø A	Ø B
RR / RRD 35	-	10
RR / RRD 100	25	30
RR / RRD 150	30	35
RR / RRD 200	35	40

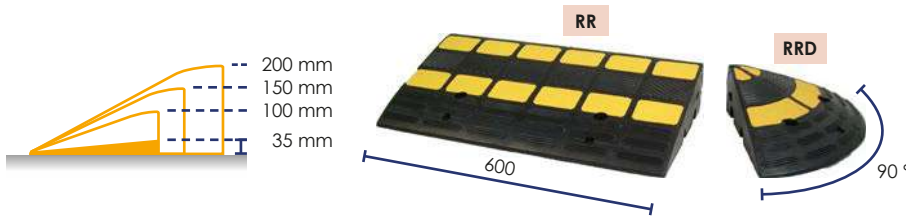
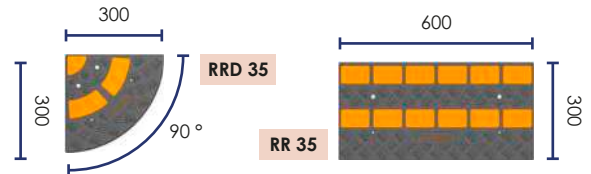

OPTION ◦ OPTIONAL ◦ OPCIÓN ◦ OPTIONAL



RR FIX 4 SB  
2 x Ø 6  
2 x Ø 10



RR SPIKE 4 SB  
2 x (Ø 7 x 300)  
2 x (Ø 10 x 300)



RQ GLUE

## ZE

Code			kg
ZE 100 RAMP	6	7	55
ZE 100 END	3	5	23
ZE 25 G	3	3	17
ZE 25 D	3	3	17

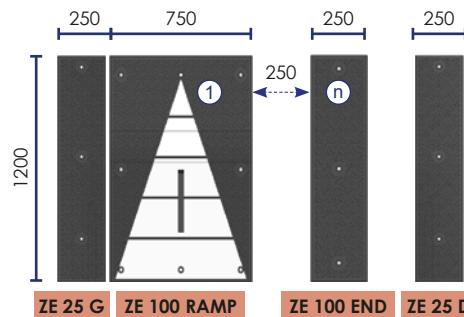

INCLUS ◦ INCLUDED ◦ INCLUIDO ◦ INKLUSIVE



FIX 1 SB  
Ø 12 x 130

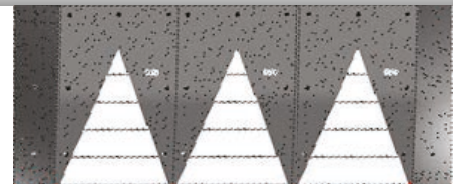

ZE 25 G ZE 100 RAMP

ZE 25 D





RR

# PLAQUE DE CHAUSSÉE

ROAD PLATE ◦ RAMPA PARA ZANJAS ◦ ÜBERFAHRPLATTE



CAOUTCHOUC VULCANISÉ  
VULCANIZED RUBBER  
CAUCHO VULCANIZADO  
VULKANISIERTEM KAUSCHUK



Code		
RR 1400	1400 x 800 x 50	18
RR 1700	1700 x 1000 x 50	20
RR 2060	2000 x 600 x 50	23

Emboitable ◦ Expandable ◦ Encajable ◦ Dehnbare



Jonction  
Junction  
Junta  
Verbindung

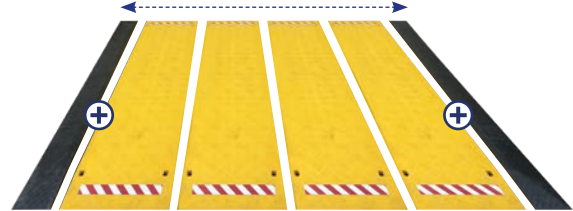

RR 1400

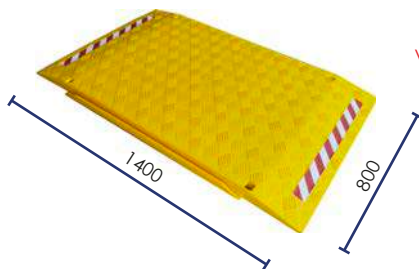

RR 1700

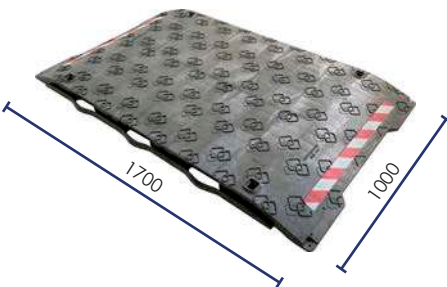

RR 2060

0,5 m	20000
0,7 m	10000
0,9 m	5000
1,2 m	1000

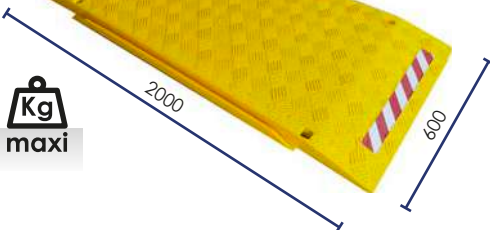

Patins anti-glisse  
Non skid pad  
Tapa antideslizante  
Rutschfest



Renforts acier  
Steel reinforcement  
Refuerzos de acero  
Stahlverstärkungen

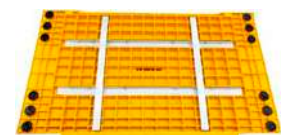

Poignée de transport  
Transport handle  
Asa de transporte  
Handgriff



Trous de fixation  
Fixation holes  
Agujeros de fijación  
Befestigungslöcher



Patins anti-glisse  
Non skid pad  
Tapa antideslizante  
Rutschfest

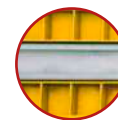

Renforts acier  
Steel reinforcement  
Refuerzos de acero  
Stahlverstärkungen

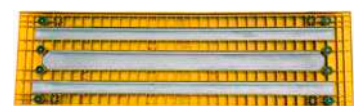

OPTION ◦ OPTIONAL ◦ OPCIÓN ◦ OPTIONAL



RR 1401 ▶ RR 1400  
RR 2001 ▶ RR 2060



RR 1701 ▶ RR 1700



RR 1400 M ▶ RR 1400  
RR 2060 M ▶ RR 2060



RR 1400 F ▶ RR 1400  
RR 2060 F ▶ RR 2060





# PASS

## PASSERELLE ◦ FOOTBRIDGE ◦ PASARELA ◦ BRÜCKE



Jonction      Emboitable  
 Junction      Expandable  
 Junta          Encajable  
 Verbindung    Dehnbare



740\*

PASS 800



1460\*

PASS 1600



2200\*

PASS 2400



859\*

PASS 1708



1859\*

PASS 1718



2859\*

PASS 1728



Code	L	* mm	kg
PASS 800	1400	740	26,5
PASS 1600		1460	48,5
PASS 2400		2200	63,0
PASS 3200		2940	81,0
PASS 1708	1700	859	38,0
PASS 1718		1859	60,0
PASS 1728		2859	82,0
PASS 2010		1030	55,0
PASS 2018	2000	1630	84,0
PASS 2024		2230	107,0



1030\*

PASS 2010



1630\*

PASS 2018



kg	maxi
0,5 m	20000
0,7 m	10000
0,9 m	5000
1,2 m	1000

\* Passage utile ◦ Useful width ◦ Ancho útil ◦ Nützliche Passage





# COUVERTURE DE TRANCHÉES

TRENCH COVER PLATE ◦ PLACA CUBRE ZANJAS ◦ GRABENABDECKUNGEN

## RR 1280

	Kg maxi
1,1 m	350
0,9 m	500
0,7 m	600
0,5 m	700

**Kg**  
maxi



14



Renforts acier  
Steel reinforcement  
Refuerzos de acero  
Stahlverstärkungen

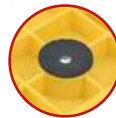

Patins anti-glisse  
Non skid pad  
Tapa antideslizante  
Rutschfest

1220



800

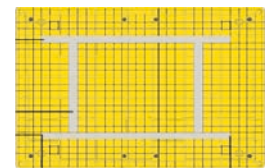

240

890



## RR 1612

	Kg maxi
1,1 m	350
0,9 m	500
0,7 m	600
0,5 m	700

**Kg**  
maxi



25



Renforts acier  
Steel reinforcement  
Refuerzos de acero  
Stahlverstärkungen



Patins anti-glisse  
Non skid pad  
Tapa antideslizante  
Rutschfest

1620



1220

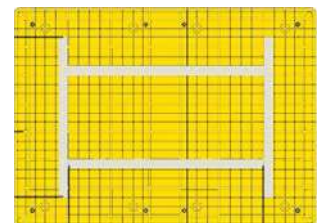

880

1050







RAMP

ADJ 1100

## RAMPE D'ACCÈS TRANSPORTABLE

TRANSPORTABLE ACCESS RAMP ◦ RAMPA DE ACCESO PORTÁTIL ◦ MOBILE RAMPEN

Code		kg maxi	kg
ADJ 1100	1120 (1010) x 750 x 160	300	9

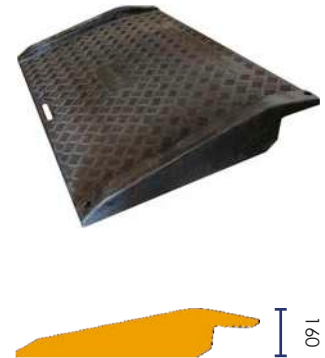
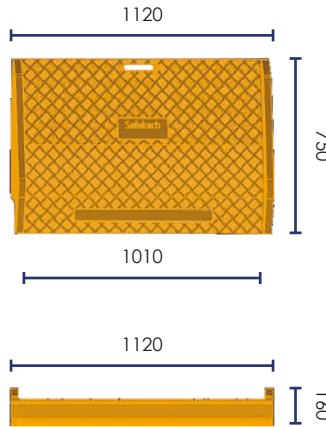

## PLIANTES ◦ FOLDABLE ◦ PLEGABLE ◦ FALTBARE

Code		kg maxi	kg
RAMP 125	1220 x 710 x 50	300	9,2
RAMP 178	1830 x 710 x 50	300	13,8



Bavette ajustable  
Adjustable plate  
Placa ajustable  
Einstellbarer Schaufel

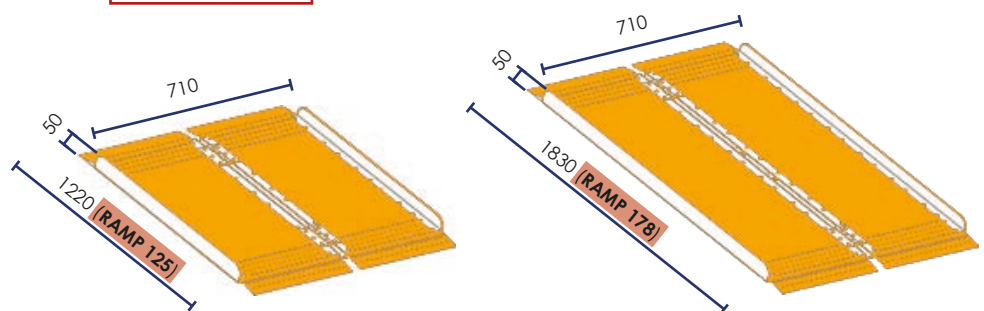







## BALISAGE ◦ MARKING ◦ SEÑALIZACIÓN ◦ WARNMARKIERUNG



**HAUTE VISIBILITÉ**  
HIGH VISIBILITY  
ALTA VISIBILIDAD  
HOHER SICHTBARKEIT

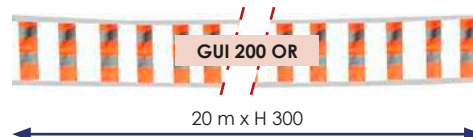
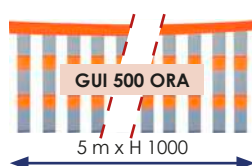

## BARRIÈRE EXTENSIBLE ◦ EXPANDABLE BARRIER ◦ BARRERA EXTENSIBLE ◦ ABSPERR-SCHERENGITTER

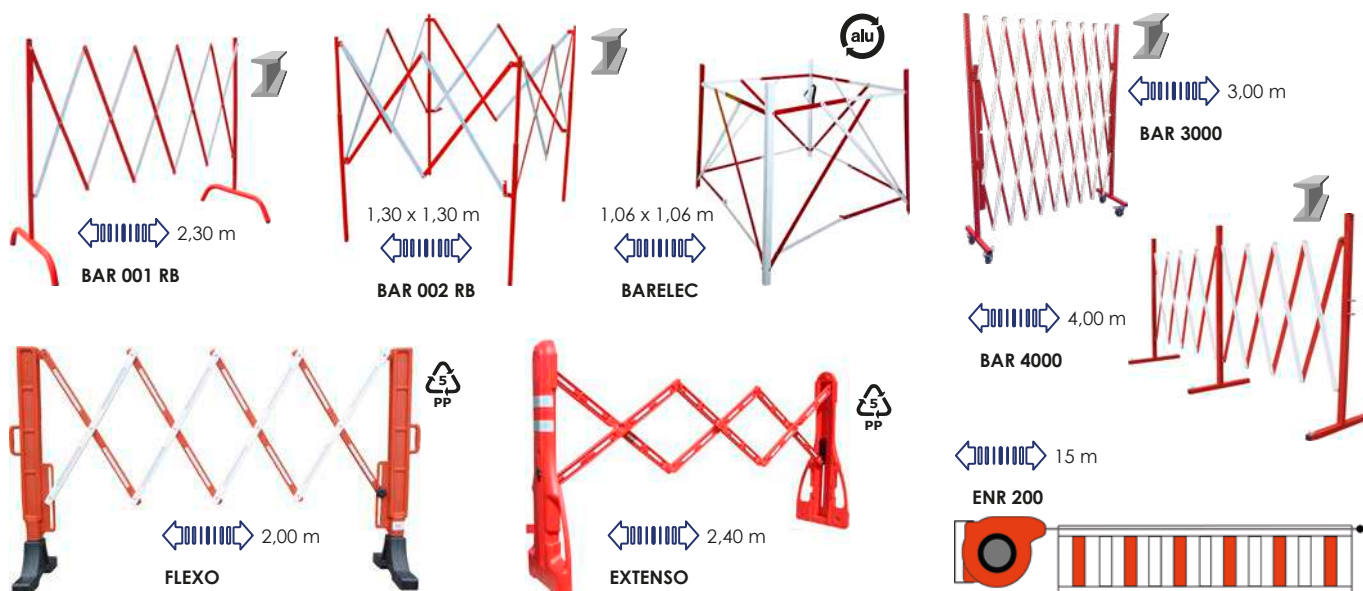

## BARRIÈRES POLYPROPYLENE

POLYPROPYLENE BARRIERS ◦ BARRERAS DE POLIPROPILENO ◦ SPERRGITTER







AK5 LED



CLASSE 1

CLASSE 2



TRIAK

PANNEAU SOLAIRE A LED

SOLAR LED TRAFFIC SIGN ◦ PANEL DE TRAFICO CON LED ◦ LEUCHTTAFELN



Informations techniques, voir page 35  
 Technical specifications see page 35  
 Datos técnicos ver página 35  
 Technische Informationen, siehe Seite 35



AK5 LED



INCLUS ◦ INCLUDED ◦ INCLUIDO ◦ INKLUSIVE



CLASSE 2

Ø 60 / 8 led Ø 5 mm

TRIPODE PLIABLE

FOLDABLE TRIPOD ◦ TRIPODE PLEGABLE ◦ DREIBEINIGEN FALTSIGNAL



TRIAK5 BL

TRIAK14 BL

Système de ressort parapluie  
 Umbrella spring system  
 Sistema de resorte tipo paraguas  
 Regenschirm-Federsystem

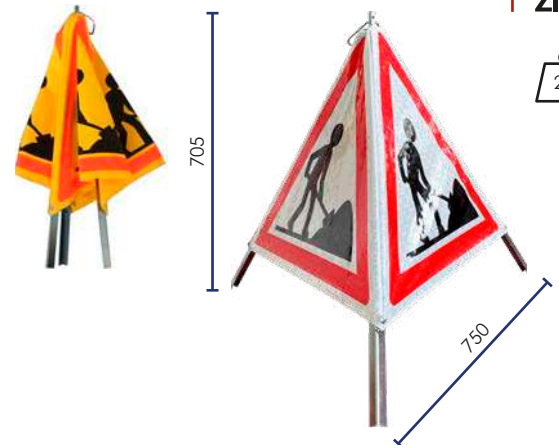

TRIAK5

TRIAK14

GÉOMÈTRE

TRIGEO

FAUCHAGE

TRIFAU

INCLUS ◦ INCLUDED ◦ INCLUIDO ◦ INKLUSIVE

Toile PP enduit PVC  
 PP fabric and PVC coating  
 Tela PP cubierto con PVC  
 PVC beschichtete Polyestergerewebe



CLASSE 1

CLASSE 2

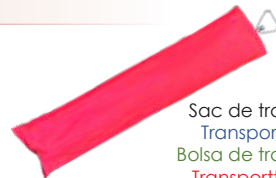

Sac de transport  
 Transport bag  
 Bolsa de transporte  
 Transporttasche

OPTION  
 OPTIONAL  
 OPCIÓN  
 OPTIONAL

Personnalisation  
 Customization  
 Personalización  
 Personalisierung

mini 50





# BAR 03 RB

## BALISAGE ◦ MARKING ◦ SEÑALIZACIÓN ◦ WARNMARKIERUNG

## BARRIÈRE DE CHANTIER ◦ BARRIER ◦ BARRERA ◦ ABSPERRUNGEN

### BAR 03 RB

Plaque personnalisable  
Customizable plate  
Placa personalizable  
Personalisierbare Platte



minimum de commande : 5 ◦ MOQ = 5 pcs  
Pedido mínimo : 5 ◦ Mindestbestellmenge: 5

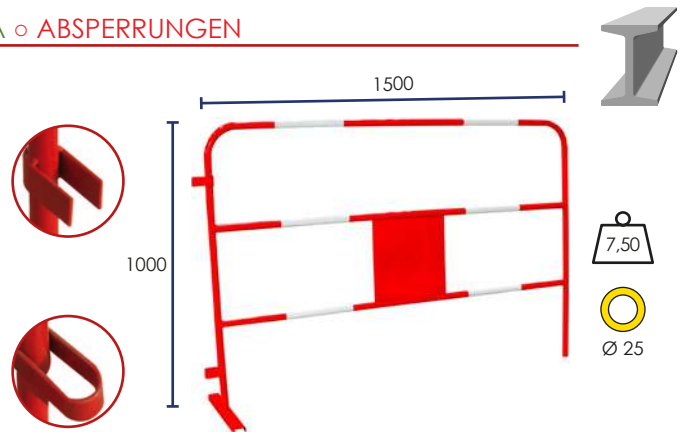

## PIQUET ◦ REFLECTIVE POSTS ◦ POSTE REFLECTIVO ◦ LEITBAKE

Code	Face(s)	Classe	
ROAD 1011	1	1	x 10
ROAD 1021	2	1	
ROAD 1012	1	2	
ROAD 1022	2	2	

Angles arrondis  
Rounded corners  
Esquinas redondeadas  
Abgerundeten Ecken



### 1 FACE

ROAD 1011  
CLASSE 1  
ROAD 1012  
CLASSE 2

### 2 FACES

ROAD 1021  
CLASSE 1  
ROAD 1022  
CLASSE 2

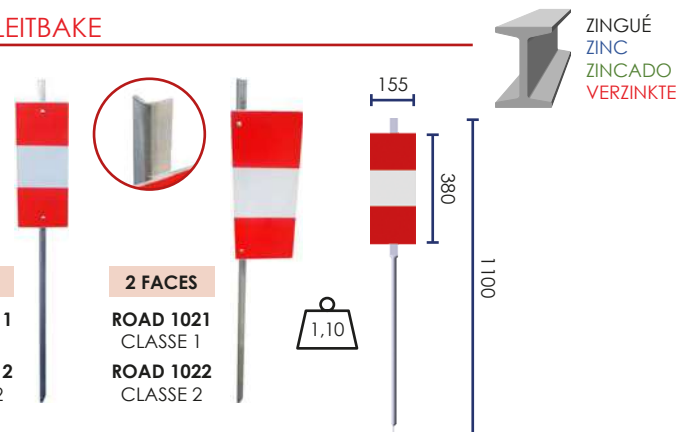

ZINGUÉ  
ZINC  
ZINCADO  
VERZINKTE

## GRILLAGE ◦ FENCE ◦ MALLA DE PROTECCIÓN ◦ FLEXIBLER ZAUN / ABSPERRNETZ

### PFR 520 SB



x 20



### SP 1205 SB

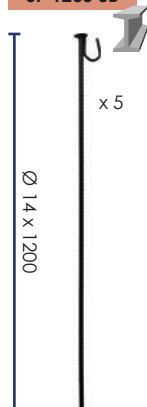

x 5

Ø 14 x 1200

### GPP 501

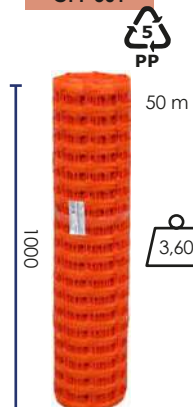

50 m



1000



115 x 50  
Maille  
Mesh  
Malla  
Masche







BAR 001 RB

BARELEC

BAR 002 RB

## BARRIÈRE EXTENSIBLE

EXPANDABLE BARRIER ◦ BARRERA EXTENSIBLE ◦ ABSPERR-SCHERENGITTER

BAR 001 RB 2,30 m

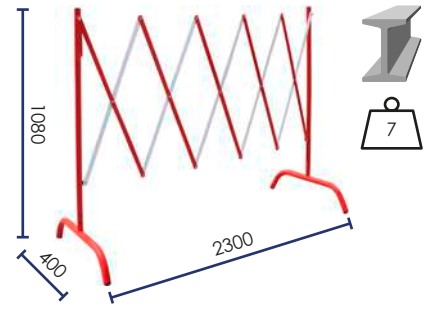
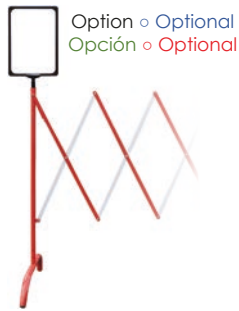

BAR 002 RB 1,30 x 1,30 m

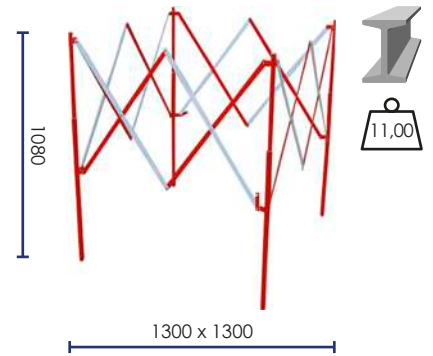
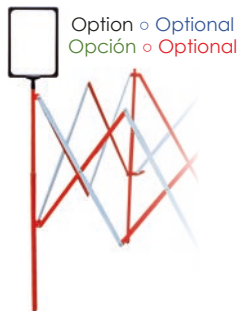

BARELEC 1,06 x 1,06 m

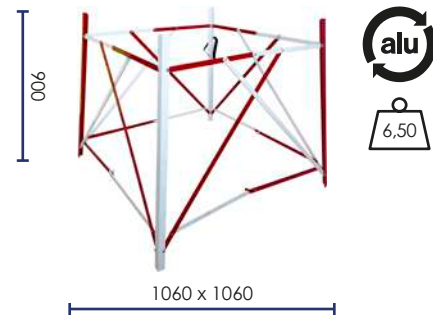
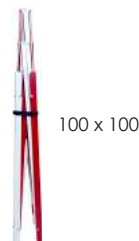

OPTION ◦ OPTIONAL ◦ OPCIÓN ◦ OPTIONAL



BAR 02 BAG  
BARELEC  
BAR 002



BAR 01 BAG



RS A4 PN  
BAR 001  
BAR 002

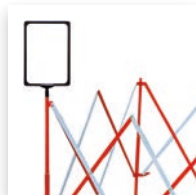





**BAR 4000**



**BAR 3000**

**BARRIÈRE EXTENSIBLE** ◦ **EXPANDABLE BARRIER**  
**BARRERA EXTENSIBLE** ◦ **SCHERRENSPERREN**



Code	
BAR 3000 RB	
BAR 3000 BK	

3,00 m



**BAR 3000 BK**

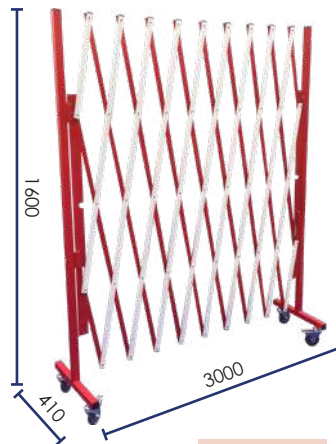

**BAR 3000 RB**



**BAR 3 EXT RB**

Code	
BAR 3 EXT RB	
BAR 3 EXT BK	

3,00 m



Ø 80

Code	
BAR 4000	
BAR 4000 NJ	
BAR 4000 BK	

4,00 m

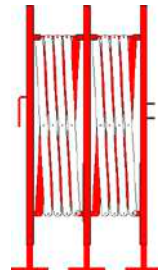

**BAR 4000**

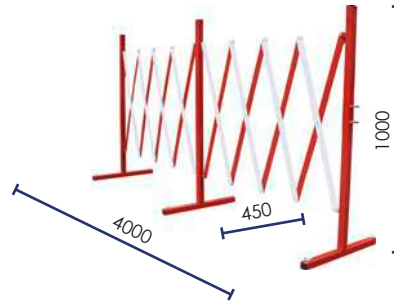

Code	
BAR 4006 RB	
BAR 4006 NJ	
BAR 4006 BK	

4,00 m



Frein  
Brake  
Freno  
Bremse



**WH 501 SB**  
Ø 50 mm



**BAR 4006 RB**

**OPTION** ◦ **OPTIONAL** ◦ **OPCIÓN** ◦ **OPTIONAL**

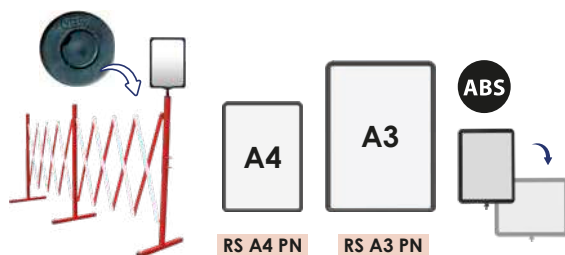

**RS A4 PN**

**RS A3 PN**

**WH 501 SB**

Frein  
Brake  
Freno  
Bremse

Ø 50 mm

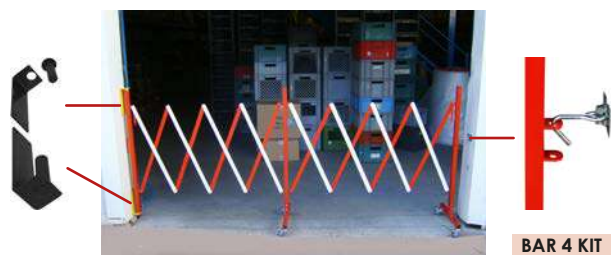

**BAR 4 KIT**

Kit de fixation murale ◦ Wall fixing kit  
Kit de fijación a la pared  
Wandbefestigungsset









**FLEXO**



**EXTENSO**

Crealuxe.fr

**BARRIÈRE EXTENSIBLE** ◦ **EXPANDABLE BARRIER**  
**BARRERA EXTENSIBLE** ◦ **ABSPERR-SCHERENGITTER**



**FLEXO** ◀▶ 2,00 m

Code		
FLEXO 200 RB		4,80
FLEXO EXTRB		3,40
FLEXO 200 NJ		4,80
FLEXO EXTNJ		3,40

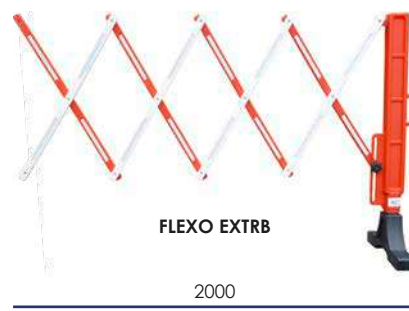
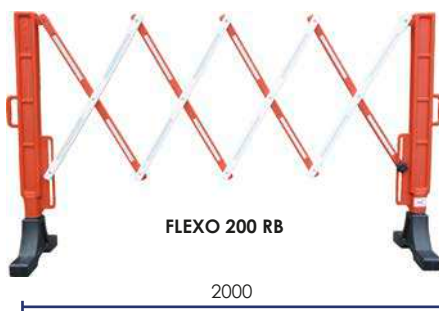
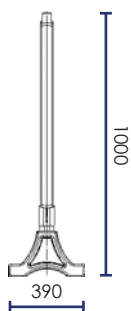

**EXTENSO** ◀▶ 2,40 m

Code		
EXTENSO		7,50
EXTENSO JA		7,50

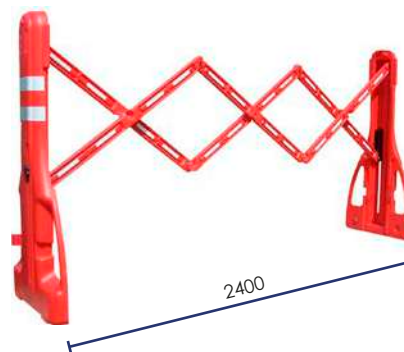
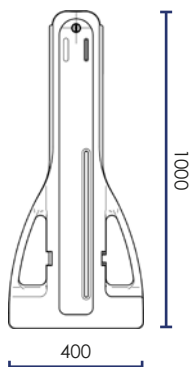
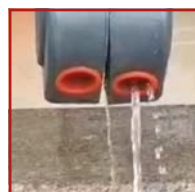

OPTION ◦ OPTIONAL ◦ OPCIÓN ◦ OPTIIONAL







# BAR 1020 / 2020

## BARRIÈRES POLYPROPYLENE POLYPROPYLENE BARRIERS BARRERAS DE POLIPROPILENO ◦ SPERRGITTER

  
Classe 1 ◦ Class 1  
Clase 1 ◦ Klasse 1

 Autres couleurs : mini 50  
Others colors : mini 50  
Otros colores : mini 50  
Andere Farben : Mini 50



Code	
<b>BAR 2020 GR</b>	RAL 7035
<b>BAR 2020 OR</b>	RAL 2004



Pieds intégrés  
With heavy feet  
Pies integrados  
Integrierte Füße

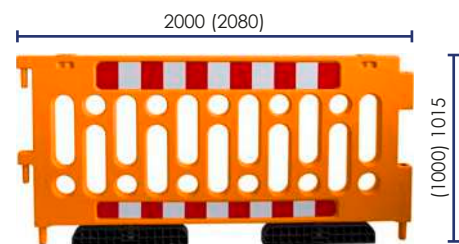
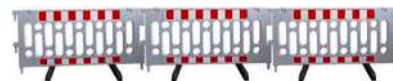

BAR 2020 OR

Code	
<b>BAR 2020 GR SP</b>	RAL 7035
<b>BAR 2020 OR SP</b>	RAL 2004



Pour base  
For base  
Para base  
Für sockel

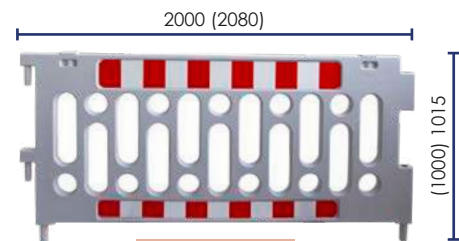
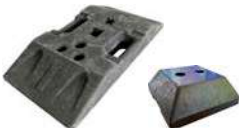

BAR 2020 GR SP

Code	
<b>BAR 1020 GR</b>	RAL 7035
<b>BAR 1020 OR</b>	RAL 2004



Pour base  
For base  
Para base  
Für sockel

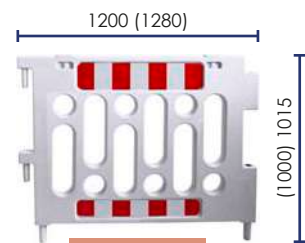

BAR 1020 GR

### OPTION ◦ OPTIONAL ◦ OPCIÓN ◦ OPTIONAL

BASE 2500

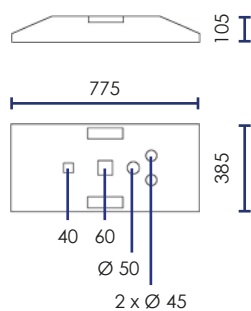

BASE 310

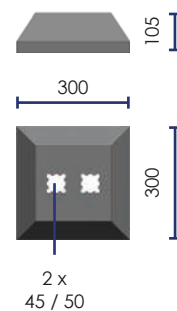

Poignée intégrée  
Built in handle  
Mango incorporado  
Handgriff



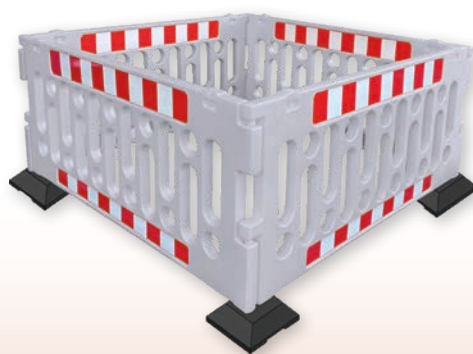

## 1200 X 1200

BAR 104 OR



BAR 134 OR



BAR 104 GR

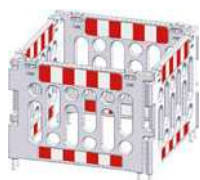

BAR 134 GR



## 2000 X 2000

BAR 204 OR



BAR 234 OR



BAR 244 OR



BAR 204 GR



BAR 234 GR



BAR 244 GR



OPTION ◦ OPTIONAL ◦ OPCIÓN ◦ OPTIONAL

Ø 180

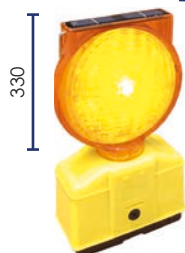

LAMP SOL



360°



3 modes d'éclairage  
3 light modes  
3 modos de iluminación  
3 Positionen

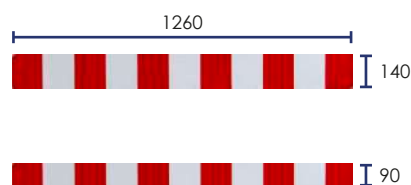

x 2  
BARTAPE 2  
Classe 2





RSNA

CHAINE

## RUBAN DE SIGNALISATION

WARNING TAPE ◦ CINTA DE SEÑALIZACIÓN ◦ ABSPERRBÄNDER



### IMPRESSION 1 FACE ◦ 1 SIDE PRINTING ◦ IMPRESIÓN A 1 CARA ◦ 1-SEITIG BEDRUCKEN

Code	
RSNA 01 RB	x 36
RSNA 121 RB	x 12
RSNA 01 NJ	x 36
RSNA 121 NJ	x 12
RSNA 01 VE	x 36
RSNA 121 VE	x 12

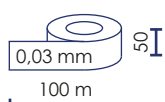

### IMPRESSION 2 FACES ◦ 2 SIDES PRINTING ◦ IMPRESIÓN A 2 CARAS ◦ 2-SEITIG BEDRUCKEN

Code	
RSNA 02 RB	x 36

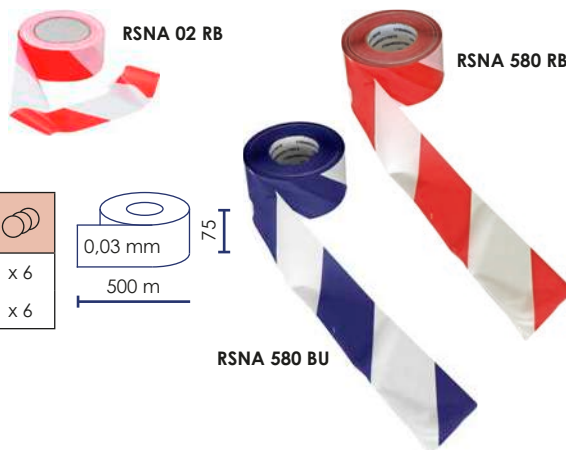
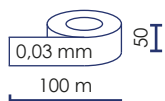

Code	
RSNA 580 RB	x 6
RSNA 580 BU	x 6

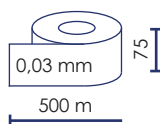

#### ACCESSOIRES ◦ ACCESSORIES ACCESORIOS ◦ ZUBEHÖR

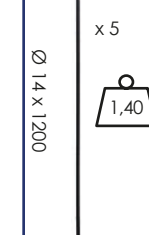
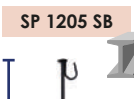

## CHAINE POLYPRO ET ACCESSOIRES

POLYPROPYLENE CHAIN ◦ CADENA DE PLÁSTICO ◦ KUNSTSTOFFKETTEN



Code	
CFLUO 825 SBS	○
CNJ 801 SBS	●
CBR 801 SBS	◐
CPB 801 SBS	○
CPR 801 SBS*	●
CBV 801 SBS	◐
CBB 801 SBS	◑
CPN 801 SBS	●

25 m - Ø 8



CFLUO 825 SBS



Accessoires ▶ p. 175  
Accessories ▶ p. 175  
Accesorios ▶ p. 175  
Zubehör ▶ p. 175

\* Epuisement stock ◦ While stock lasts ◦ Hasta agotar existencias ◦ Lagerverrat Begrenzung





GUI 200

GUI 500

**BANDEAU DE SIGNALISATION TISSU** ○ HIGH VISIBILITY WARNING STRIP  
**BANDA DE ADVERTENCIA ALTA VISIBILIDAD** ○ **BAND MIT HOHER SICHTBARKEIT**



5 M



Bandes lestées  
 Weighted bottom  
 Bandas lastradas  
 unten des Bands gewichtet

GUI 500 OR

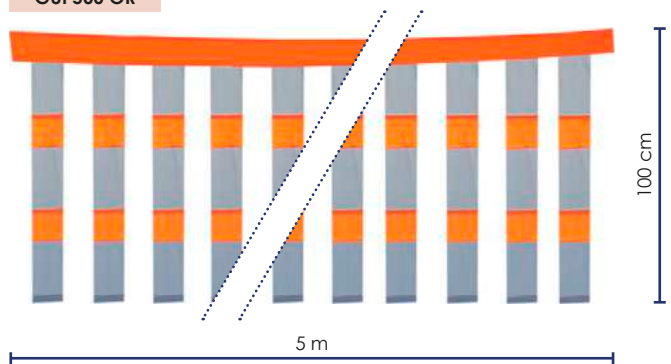

20 M



Bandes réfléchissantes  
 Reflective tapes  
 Tiras reflectantes  
 Reflektierende Streifen

GUI 200 OR

CLASSE 1

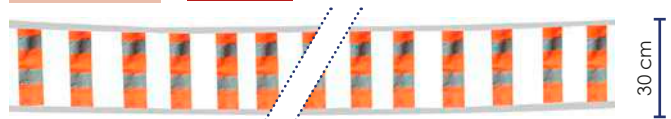

GUI 200 RB

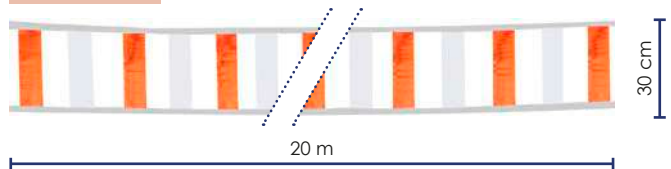

INCLUS ○ INCLUDED ○ INCLUIDO ○ INKLUSIVE



Sac de rangement  
 Storage bag  
 Bolsa de almacenamiento  
 Aufbewahrungstasche

OPTION ○ OPTIONAL ○ OPCIÓN ○ OPTIONAL

ENR 200 ROUTE  
 87 x 28 cm

ROUTE BARREE

ENR 200 ACCES  
 87 x 28 cm

ACCES INTERDIT

ENR 200 SI  
 29 x 27 cm







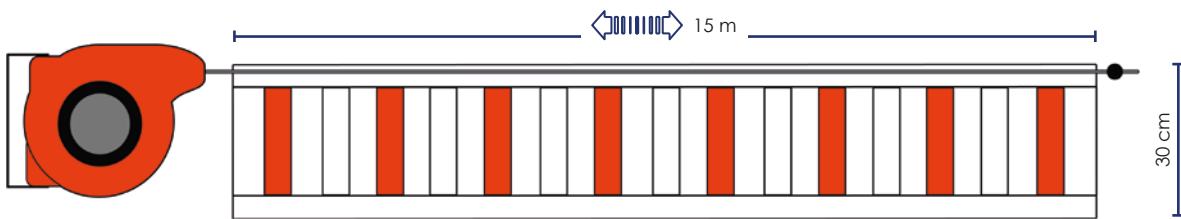

ENR 200

**BARRIÈRE AVEC ENROULEUR** ◦ **EXPANDABLE / RETRACTABLE BARRIER**  
**BARRERA DE SEÑALIZACIÓN CON ENROLLADOR** ◦ **EINZIEHBARE ABSPERROLLE**



390 x 120 x 270  4.0



**ENR 200 OR**  
 Réflechissant  
 Reflective  
 Reflektivo  
 Reflektierend

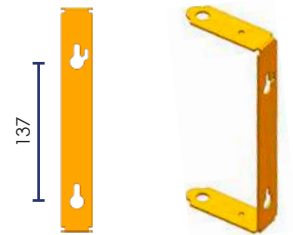

**ENR 200 RB**



**ENR 200 NJ**

**INCLUS** ◦ **INCLUDED**  
**INCLUIDO** ◦ **INKLUSIVE**



**OPTION** ◦ **OPTIONAL** ◦ **OPCIÓN** ◦ **OPTIONAL**

**ENR 200 ROUTE**  
 87 x 28 cm

**ROUTE BARREE**

**ENR 200 ACCES**  
 87 x 28 cm

**ACCES INTERDIT**

**ENR 200 SI**  
 29 x 27 cm







ENR 200

**OPTIONS** ○ **OPTIONS** ○ **OPCIONES** ○ **OPTIONEN**

**ENR BOX**

500 x 200 x H 480



Porte coulissante  
Sliding door  
Puerta corrediza  
Schiebetürsystem



**ENR POST 140**



Poteau support et récepteur  
Fixing post and receiver  
Poste soporte y receptor  
Doppelte Funktion: Träger und Empfänger

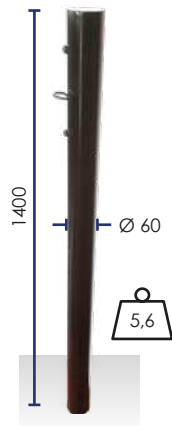

**BASE 2500**

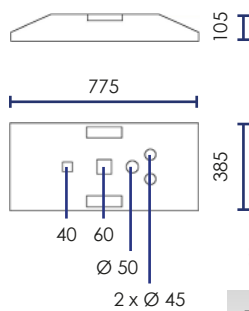

ENR 200 + BBASE

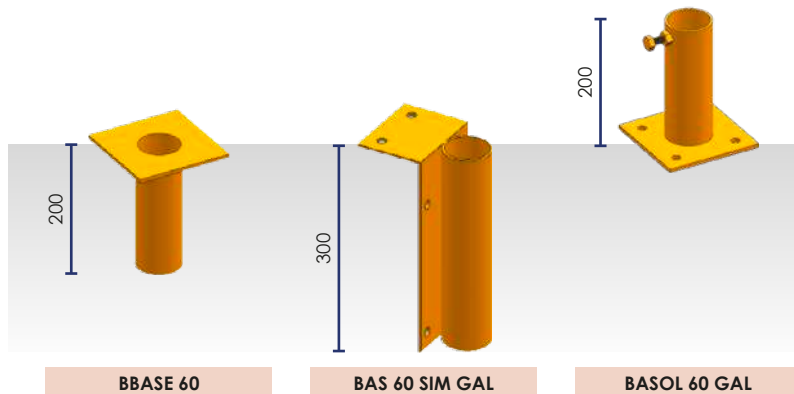

BBASE 60

BAS 60 SIM GAL

BASOL 60 GAL





LAMPES ◦ SAFETY LAMPS ◦ LUZ DE SEÑALIZACIÓN ◦ SIGNALISIERUNG

**LAMPSOL 180**

360°

Ø 180

330

3 modes d'éclairage  
3 light modes  
3 modos de iluminación  
3 Positionen

ON / OFF

**LAMPSOL**

360°

Ø 180

330

3 modes d'éclairage  
3 light modes  
3 modos de iluminación  
3 Positionen

**FLASH 90**

360°

Ø 80

160

Ø 35

ON / OFF

**FLASH 101OR**

111 x 104 x 35

1500 m

360°

IP67

Lithium

+ 50 °C  
- 20 °C

ON / OFF

FLASH 101OR x 1

FLASH 106OR x 6

70

350

370

9 modes de clignotements ▶ fiche technique  
9 flash modes ▶ data sheet  
9 modos de destello ▶ ficha tecnica  
9 Positionen ▶ datenblatt

60 H

**FAR 001**

200

Ø 95

VESTES DE SÉCURITÉ ◦ SAFETY VEST ◦ CHALECO DE SEGURIDAD ◦ SICHERHEITSJACKE

ISO 20471 ◦ Taille unique XL ◦ XL size ◦ Talla XL ◦ Einzelne Größe XL







by VISO

by VISO

by VISO

VISO

VISO

VISO

flowers gallery

RUE DE LA BOUCHÈRE

PLACE





**PARAVENT / BARRIÈRE DE PROTECTION**

- Auto portante
- 2 hauteurs : 1 m ou 1,80 m
- En 3 vantaux
- Inox ou PVC
- Repliable
- Tissus à assembler sur l'armature par le client
- Tissu imprimé 1 face.
- Panneaux décoratifs avec velcro :
  - ▷ Facile à mettre en place
  - ▷ Facile à tendre
  - ▷ Tissus lavables

**SCREEN / PROTECTION BARRIER**

- Self Standing
- 2 heights: 1 m or 1.80 m
- In 3 panels
- Stainless steel or PVC
- Foldable
- Fabrics to be mounted on the frame by the customer
- 1 side printed fabric
- Decorative panels with velcro :
  - ▷ Easy to put in place
  - ▷ Easy to stretch
  - ▷ Washable fabrics

**BIOMBO / BARRERA DE SEÑALIZACIÓN**

- Estructura autoportante
- 2 alturas: 1 m o 1,80 m
- De 3 paneles
- Acero inoxidable o PVC
- Plegable
- Armados de los tejidos en el marco por el cliente
- Tejido impreso a 1 cara
- Paneles decorativos con velcro:
  - ▷ Fácil de colocar
  - ▷ Fácil de tender
  - ▷ Tejidos lavables

**SCHUTZ BARRIERE / SICHTSCHUTZ**

- Freistehend
- Höhe : 1m oder 1,8m
- 3 Sicht- / Schutzfelder
- Ständer Ausführung in Stahl oder Kunststoff
- Faltbar
- Montage der Elemente vor Ort durch Kunden
- 1 Seite ist bedruckt.
- Bespannung mit Klettverschluss :
  - ▷ einfach zu montieren
  - ▷ ist dehnbar
  - ▷ waschbar



**PERSONNALISATION** ◦ **CUSTOMIZATION** ◦ **PERSONALIZACIÓN** ◦ **PERSONALISIERUNG**

**TRAVO PRINT**

Minimum 15 barrières (de 3 panneaux) ◦ Minimum order 15 barriers (3 panels)  
 Pedido mínimo: 15 barreras (3 paneles)  
 Mini Bestellungen 15 Absperrungen (3 Sicht- / Schutzfelder)

**TYPE DE TISSU** ◦ **FABRIC CHOICE**

**TIPO DE TEJIDO** ◦ **STOFFAUSWAHL**



IGNIFUGE

**Tissu ignifugé**, impression 3 couleurs  
**Flame retardant fabric**, 3 colors printing  
**Tejido ignífugo**, Impresión a 3 colores  
**Flammfestes Gewebe**, 3 Farben-Druck



**Tissu brise vent**, impression 3 couleurs  
**Windproof fabric**, 3 colors printing  
**Tejido cortaviento**, Impresión a 3 colores  
**Winddichtes Gewebe**, 3 Farben-Druck

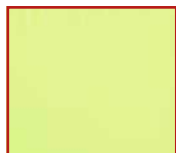

**Tissu standard**, impression quadri  
**Standard fabric**, 4 colors printing  
**Tejido estándar**, Impresión a 4 colores  
**Standard Gewebe**, 4 Farben-druck



**COULEUR**

**COLOR** ◦ **COLOR** ◦ **FARBEN**



Personnalisation  
 Customization  
 Personalización  
 Personalisierung

Standard  
 Standard  
 Estándar  
 Standard



**FIXATION TISSU** ◦ **FABRIC FIXATION**

**FIJACIÓN DEL TEJIDO** ◦ **GEWEBE BEFESTIGUNGS**



**Velcro**

Délai 5 semaines  
 Lead-time 5 weeks  
 Plazo de entrega : 5 semanas  
 Frist 5 Wochen



**Cousu**, délai 10 semaines  
**Sewn**, within 10 weeks  
**Cosido**, plazo de 10 semanas  
**Genäht**, Frist 10 Wochen

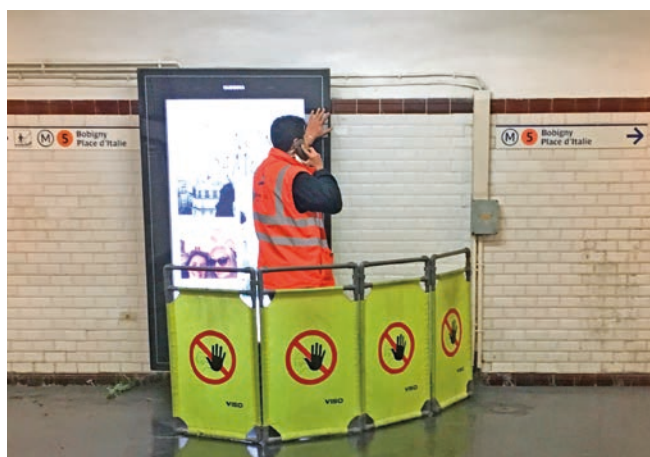

**OPTION**  
**OPTIONAL**  
**OPCIÓN**  
**OPTIONAL**



TRAVOBAG 100



TRAVOFEET 128

Pour  
 For  
 Para  
 Für  
 TRAVO 128 / 228



TRAVOBASE

Pour  
 For  
 Para  
 Für  
 TRAVO 100 / 180





## TRAVO 100

### VERSION CLASSIQUE ◦ CLASSIC VERSION ◦ VERSIÓN CLÁSICA ◦ KLASSISCHE VERSION

- **Structure PVC** (4.2 kg - H 1 m)
  - ▷ Légère, maniable et facilement transportable
  - ▷ Jonction en PVC pour maintenir les panneaux entre eux
  - ▷ Facile à déplier et replier
  - ▷ Utilisable en milieu humide
  - ▷ Ne craint pas la pluie
- **PVC structure** (4.2 kg - H 1 m)
  - ▷ Lightweight, easy to use and transport
  - ▷ PVC link to hold the panels together
  - ▷ Easy to unfold and fold
  - ▷ Can be used in a humid environment
  - ▷ Rain resistant
- **Estructura de PVC** (4.2 kg - H 1 m)
  - ▷ Ligero, fácil de usar y transportar
  - ▷ Enlace de PVC para unir los paneles
  - ▷ Fácil de desplegar y plegar
  - ▷ Puede usarse en un ambiente húmedo
  - ▷ Resistente a la lluvia
- **PVC- Material-Struktur** (Gewicht 4,2 kg - H 1 m)
  - ▷ Geringes Gewicht, handlich und leicht zu transportieren
  - ▷ Verbindungselemente aus Kunststoff
  - ▷ Leicht zu entfalten und zusammenlegen
  - ▷ In feuchter Umgebung verwendbar
  - ▷ Regen resistant



TRAVOLTE





# TRAVO 100

## BARRIÈRE D'INTERVENTION LÉGÈRE o PVC PROTECTION BARRIER BARRERA DE SEÑALIZACIÓN EN PVC o LEICHTE ABSPERRUNG

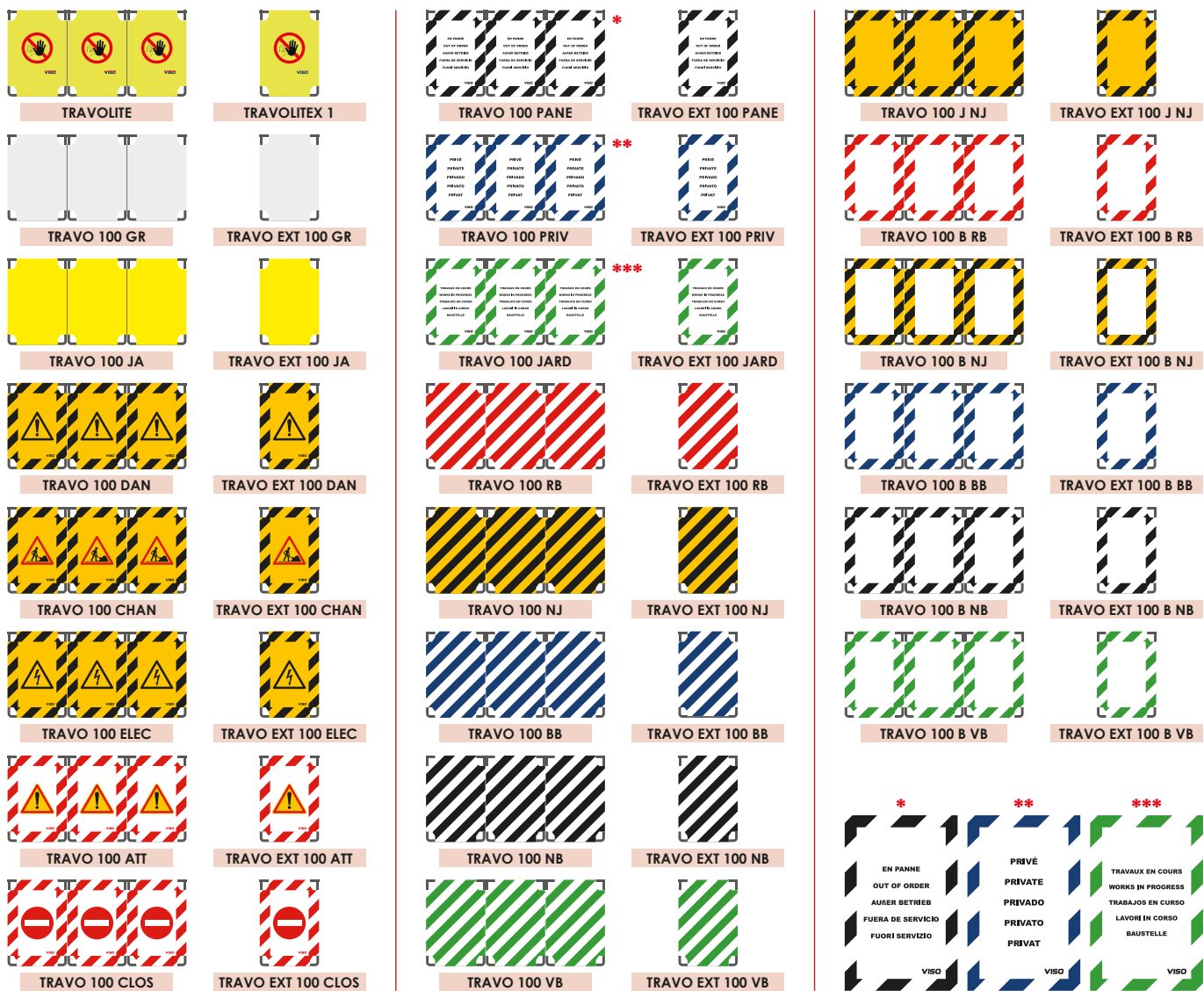

OPTION  
OPTIONAL  
OPCIÓN  
OPTIONAL

TRAVOBAG 100



TRAVOBASE







## TRAVO 128

### VERSION DESIGN ◦ VERSIÓN DESIGN ◦ VERSIÓN DESIGN ◦ DESIGN VERSION

- **Structure Inox** (10,5 kg - H 1 m)
  - ▷ Charnières boulonnées pour maintenir les panneaux entre eux
  - ▷ Stabilité renforcée
  - ▷ Intérieur / Extérieur
  - ▷ Convient en milieu humide
  - ▷ Ne craint pas la pluie
- **Stainless steel structure** (10,5 kg - H 1 m)
  - ▷ Bolt-on hinges to hold panels together
  - ▷ Reinforced stability
  - ▷ Indoor / Outdoor
  - ▷ Can be used in a humid environment
  - ▷ Rain resistant
- **Posibilité de fixation longue durée** avec des platines
  - ▷ Possibility of long-term fixing thanks to the fixing plate
- **Estructura de acero inoxidable** (10,5 kg - H 1 m)
  - ▷ Bisagras atornilladas para unir los paneles
  - ▷ Estabilidad reforzada
  - ▷ Interior / Exterior
  - ▷ Puede usarse en un ambiente húmedo
  - ▷ Resistente a la lluvia
- **Posibilidad de fijación a largo plazo** gracias a la placa de fijación
- **Edelstahlkonstruktion** (Gewicht 10,5 kg - H 1 m)
  - ▷ Anschraubbare Scharniere zum Zusammenhalten der Paneele.
  - ▷ Verstärkte Stabilität
  - ▷ Anwendung: Innen / Außen
  - ▷ Geeignet in feuchter Umgebung
  - ▷ Regen resistent
- **Möglichkeit der Langzeitfixierung** mittels Boden-Platten







# TRAVO 128

## BARRIÈRE D'INTERVENTION INOX ◦ STAINLESS STEEL PROTECTION BARRIER BARRERA DE SEÑALIZACIÓN EN ACERO INOXIDABLE ◦ ABSPERRUNG AUS INOX

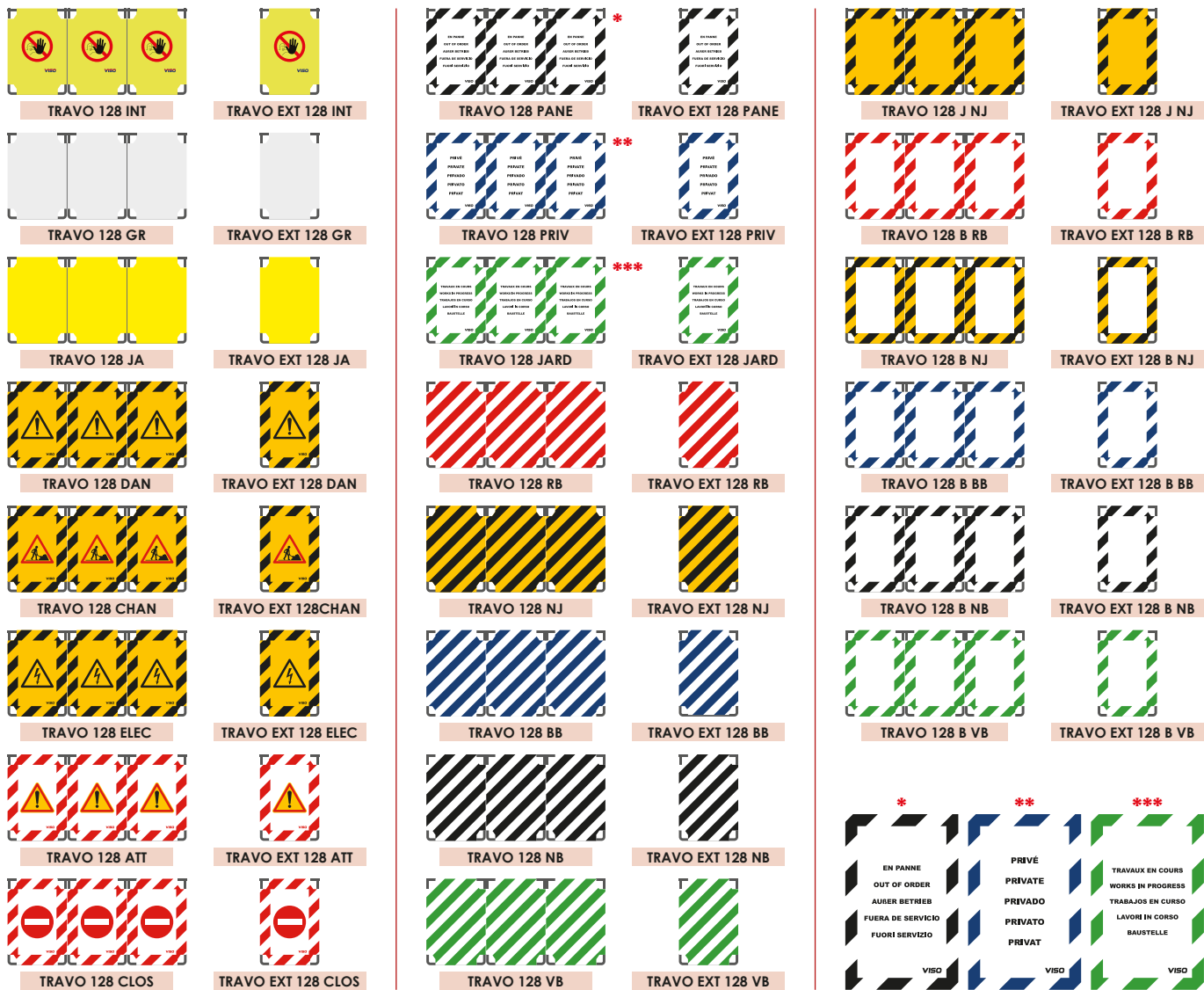
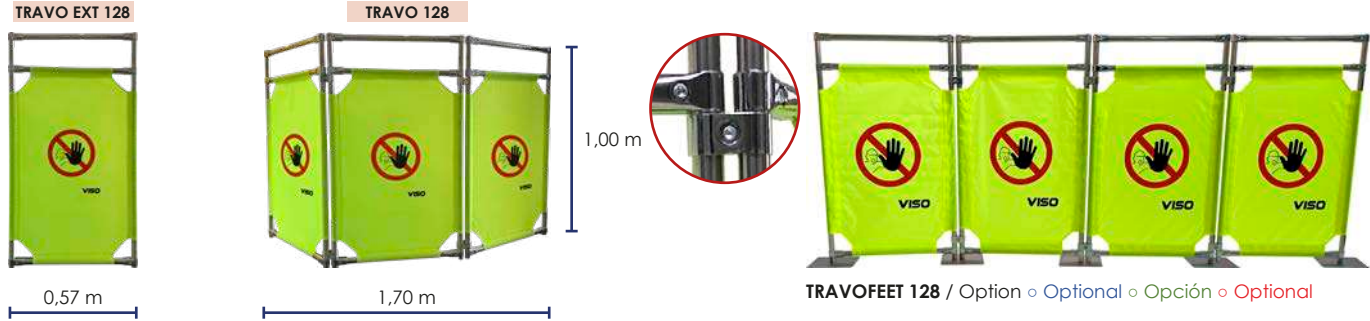

OPTION  
OPTIONAL  
OPCIÓN  
OPTIONAL



TRAVOBAG 100



TRAVOFEET 128





## TRAVO 180

### VERSION CLASSIQUE ◦ CLASSIC VERSION ◦ VERSIÓN CLÁSICA ◦ KLASSISCHE VERSION

- **Structure PVC** (6,5 kg - H 1,80 m)
  - ▷ Légère, maniable et facilement transportable
  - ▷ Jonction en PVC pour maintenir les panneaux entre eux
  - ▷ Facile à déplier et replier
  - ▷ Utilisable en milieu humide
  - ▷ Ne craint pas la pluie
- **PVC structure** (6,5 kg - H 1,80 m)
  - ▷ Lightweight, easy to use and transport
  - ▷ PVC link to hold the panels together
  - ▷ Easy to unfold and fold
  - ▷ Can be used in a humid environment
  - ▷ Rain resistant
- **Estructura de PVC** (6,5 kg - H 1,80 m)
  - ▷ Ligero, fácil de usar y transportar
  - ▷ Enlace de PVC para unir los paneles
  - ▷ Fácil de desplegar y plegar
  - ▷ Puede usarse en un ambiente húmedo
  - ▷ Resistente a la lluvia
- **PVC- Material-Struktur** (Gewicht 6,5kg - H 1,80 m)
  - ▷ Geringes Gewicht, handlich und leicht zu transportieren
  - ▷ Verbindungselemente aus Kunststoff
  - ▷ Leicht zu entfalten und zusammenlegen
  - ▷ In feuchter Umgebung verwendbar
  - ▷ Regen resistant



OPTION  
OPTIONAL  
OPCIÓN  
OPTIONAL



TRAVOBAG 180







# TRAVO 180

**BARRIÈRE D'INTERVENTION LÈGÈRE** ○ PVC PROTECTION BARRIER  
 BARRERA DE SEÑALIZACIÓN EN PVC ○ LEICHTE ABSPERRUNG

TRAVO 180 INT	TRAVO EXT 180 INT	TRAVO 180 PANE	TRAVO EXT 180 PANE	TRAVO 180 J NJ	TRAVO EXT 180 J NJ
TRAVO 180 GR	TRAVO EXT 180 GR	TRAVO 180 PRIV	TRAVO EXT 180 PRIV	TRAVO 180 B RB	TRAVO EXT 180 B RB
TRAVO 180 JA	TRAVO EXT 180 JA	TRAVO 180 JARD	TRAVO EXT 180 JARD	TRAVO 180 B NJ	TRAVO EXT 180 B NJ
TRAVO 180 DAN	TRAVO EXT 180 DAN	TRAVO 180 RB	TRAVO EXT 180 RB	TRAVO 180 B BB	TRAVO EXT 180 B BB
TRAVO 180 CHAN	TRAVO EXT 180 CHAN	TRAVO 180 NJ	TRAVO EXT 180 NJ	TRAVO 180 B NB	TRAVO EXT 180 B NB
TRAVO 180 ELEC	TRAVO EXT 180 ELEC	TRAVO 180 BB	TRAVO EXT 180 BB	TRAVO 180 B VB	TRAVO EXT 180 B VB
TRAVO 180 ATT	TRAVO EXT 180 ATT	TRAVO 180 NB	TRAVO EXT 180 NB	TRAVO 180 B VB	TRAVO EXT 180 B VB
TRAVO 180 CLOS	TRAVO EXT 180 CLOS	TRAVO 180 VB	TRAVO EXT 180 VB	TRAVO 180 B VB	TRAVO EXT 180 B VB
				TRAVO 180 B VB	TRAVO EXT 180 B VB





## TRAVO 228

### VERSION DESIGN ◦ VERSIÓN DESIGN ◦ VERSIÓN DESIGN ◦ DESIGN VERSION

- **Structure Inox** (18 kg - H 1,80 m)
  - ▷ Charnières boulonnées pour maintenir les panneaux entre eux
  - ▷ Stabilité renforcée
  - ▷ Intérieur / Extérieur
  - ▷ Convient en milieu humide
  - ▷ Ne craint pas la pluie
- **Stainless steel structure** (18 kg - H 1,80 m)
  - ▷ Bolt-on hinges to hold panels together
  - ▷ Reinforced stability
  - ▷ Indoor / Outdoor
  - ▷ Can be used in a humid environment
  - ▷ Rain resistant
- **Estructura de acero inoxidable** (18 kg - H 1,80 m)
  - ▷ Bisagras atornilladas para unir los paneles
  - ▷ Estabilidad reforzada
  - ▷ Interior / Exterior
  - ▷ Puede usarse en un ambiente húmedo
  - ▷ Resistente a la lluvia
- **Edelstahlkonstruktion** (Gewicht 18 kg - H 1,80 m)
  - ▷ Anschraubbare Scharniere zum Zusammenhalten der Paneele.
  - ▷ Verstärkte Stabilität
  - ▷ Anwendung: Innen / Außen
  - ▷ Geeignet in feuchter Umgebung
  - ▷ Regen resistent
- **Möglichkeit der Langzeitfixierung** mittels Boden-Platten

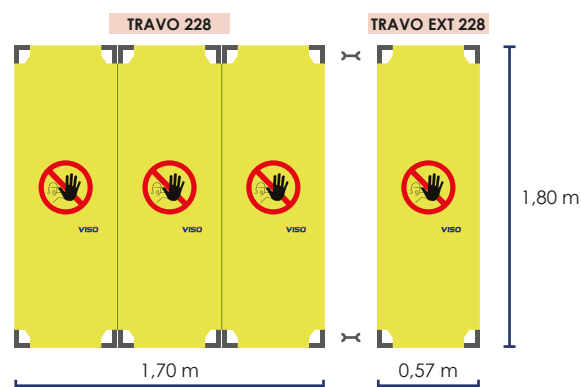





# TRAVO 228

**BARRIÈRE D'INTERVENTION INOX** ◦ STAINLESS STEEL PROTECTION BARRIER  
 BARRERA DE SEÑALIZACIÓN EN ACERO INOXIDABLE ◦ **ABSPERRUNG AUS INOX**

		<td> <td> <td> </td></td></td>	<td> <td> </td></td>	<td> </td>	
TRAVO 228 INT	TRAVO EXT 228 INT	TRAVO 228 PANE	TRAVO EXT 228 PANE	TRAVO 228 J NJ	TRAVO EXT 228 J NJ
<td> <td> <td> <td> <td> </td></td></td></td></td>	<td> <td> <td> <td> </td></td></td></td>	<td> <td> <td> </td></td></td>	<td> <td> </td></td>	<td> </td>	
TRAVO 228 GR	TRAVO EXT 228 GR	TRAVO 228 PRIV	TRAVO EXT 228 PRIV	TRAVO 228 B RB	TRAVO EXT 228 B RB
<td> <td> <td> <td> <td> </td></td></td></td></td>	<td> <td> <td> <td> </td></td></td></td>	<td> <td> <td> </td></td></td>	<td> <td> </td></td>	<td> </td>	
TRAVO 228 JA	TRAVO EXT 228 JA	TRAVO 228 JARD	TRAVO EXT 228 JARD	TRAVO 228 B NJ	TRAVO EXT 228 B NJ
<td> <td> <td> <td> <td> </td></td></td></td></td>	<td> <td> <td> <td> </td></td></td></td>	<td> <td> <td> </td></td></td>	<td> <td> </td></td>	<td> </td>	
TRAVO 228 DAN	TRAVO EXT 228 DAN	TRAVO 228 RB	TRAVO EXT 228 RB	TRAVO 228 B BB	TRAVO EXT 228 B BB
<td> <td> <td> <td> <td> </td></td></td></td></td>	<td> <td> <td> <td> </td></td></td></td>	<td> <td> <td> </td></td></td>	<td> <td> </td></td>	<td> </td>	
TRAVO 228 CHAN	TRAVO EXT 228 CHAN	TRAVO 228 NJ	TRAVO EXT 228 NJ	TRAVO 228 B NB	TRAVO EXT 228 B NB
<td> <td> <td> <td> <td> </td></td></td></td></td>	<td> <td> <td> <td> </td></td></td></td>	<td> <td> <td> </td></td></td>	<td> <td> </td></td>	<td> </td>	
TRAVO 228 ELEC	TRAVO EXT 228ELEC	TRAVO 228 BB	TRAVO EXT 228 BB	TRAVO 228 B VB	TRAVO EXT 228 B VB
<td> <td> <td> <td colspan="2" rowspan="2"> </td> </td></td></td>	<td> <td> <td colspan="2" rowspan="2"> </td> </td></td>	<td> <td colspan="2" rowspan="2"> </td> </td>	<td colspan="2" rowspan="2"> </td>		
TRAVO 228 ATT	TRAVO EXT 228 ATT	TRAVO 228 NB	TRAVO EXT 228 NB		
<td> <td> <td> <td colspan="2"></td> </td></td></td>	<td> <td> <td colspan="2"></td> </td></td>	<td> <td colspan="2"></td> </td>	<td colspan="2"></td>		
TRAVO 228 CLOS	TRAVO EXT 228 CLOS	TRAVO 228 VB	TRAVO EXT 228 VB		





A series of horizontal red lines spanning the width of the page, providing a template for writing notes.





## Protections industrielles

Industrial protections



## BARRIÈRES ◦ BARRIERS

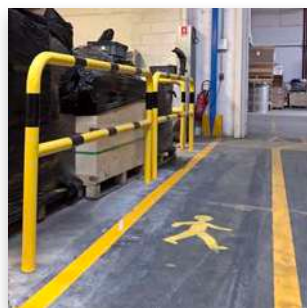

## ARCEAUX ET ÉTRIERS ◦ HOOPS AND PROTECTIONS

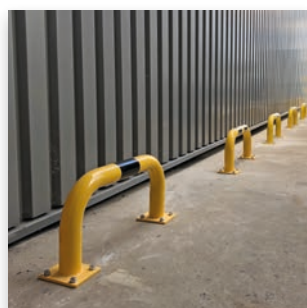

## BUTÉES ◦ BARS

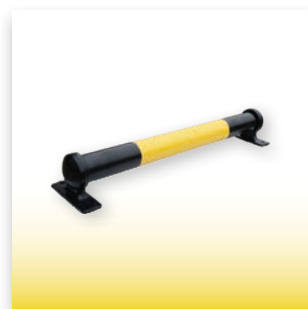

## POTEAUX ◦ POSTS





## PROTECTIONS À MÉMOIRE DE FORME ◦ FLEXIBLE PROTECTIONS

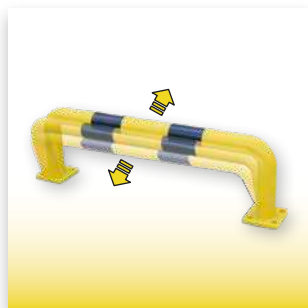

## PROTECTIONS MOUSSE ◦ FOAM PROTECTIONS



## PROTECTIONS CAOUTCHOUC ◦ RUBBER PROTECTIONS



## EQUIPEMENTS DE QUAIS ◦ DOCK EQUIPMENT







BAR

## BARRIÈRE À FIXER

BARRIERS TO FIX ◦ BARRERA CON BASE ◦ RAMMSCHUTZBÜGEL MIT PLATTE



Code		
BAR 400 RB		6,80
BAR 400 NJ		6,80
BAR 400 J		6,80
BAR 415 RB		8,50
BAR 415 NJ		8,50
BAR 415 J		8,50
BAR 420 RB		9,60
BAR 420 NJ		9,60
BAR 420 J		9,60

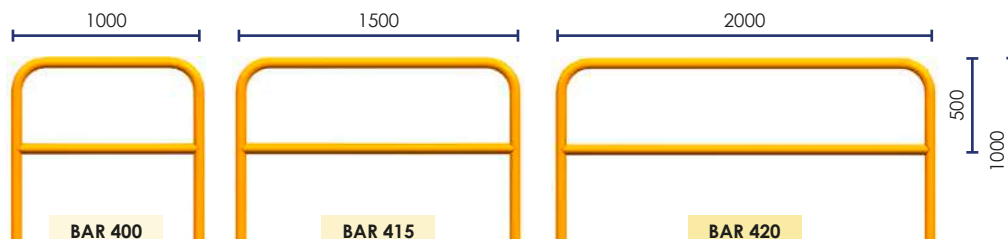
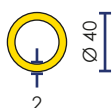

Code	
BAR 400 INOX	6,80
BAR 415 INOX	8,50
BAR 420 INOX	9,60

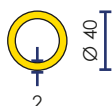

Code	
BAR 400 GAL	6,80
BAR 415 GAL	8,50
BAR 420 GAL	9,60

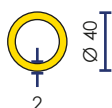

Bords arrondis  
Rounded edges  
Bordes redondeados  
Abgerundete Ecken



Espace limité entre 2  
Limited space between 2  
Espacio limitado entre 2  
Begrenzter Raum zwischen 2

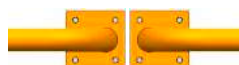

OPTION ◦ OPTIONAL ◦ OPCIÓN ◦ OPTIONAL



BAR FIX 1 SB



BAR FIX 8 SB



BAR FIX 304 SB

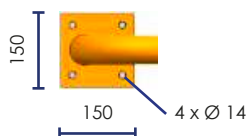

Ne pas installer en milieu salin ou Hydrocarbure. Nous consulter.  
Do not install in saline or Oil environment. Contact us.  
No lo instale en un ambiente salino o hidrocarburo. Consultenos.  
Soll nicht in Salz oder Kohlenstoff Umgebung installiert werden, /uns Konsultieren.

Sauf ◦ Except ◦ Salvo ◦ Nur







BAR

**BARRIÈRE À FIXER**

**BARRIERS TO FIX** ◦ **BARRERA CON BASE** ◦ **RAMMSCHUTZBÜGEL MIT PLATTE**



Code	kg
BAR 500 GAL	4,00

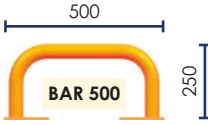
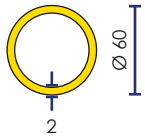

Code	Color	kg
BAR 600 RB	Red/White	9,70
BAR 600 NJ	Black/Yellow	9,70
BAR 600 J	Yellow	9,70
BAR 620 RB	Red/White	13,80
BAR 620 NJ	Black/Yellow	13,80
BAR 620 J	Yellow	13,80

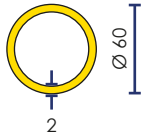

**PEINTURE ÉPOXY**  
POWDER PAINTING  
PINTURA EPOXICA  
EPOXY FARBE

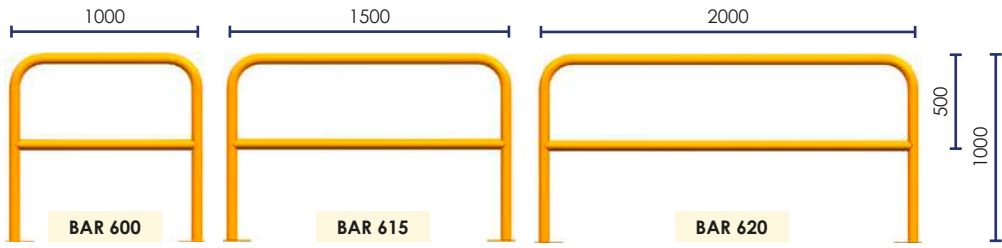

Code	kg
BAR 600 GAL	9,70
BAR 615 GAL	12
BAR 620 GAL	13,8

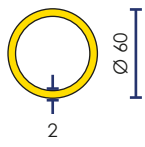

Bords arrondis  
Rounded edges  
Bordes redondeados  
Abgerundete Ecken



Espace limité entre 2  
Limited space between 2  
Espacio limitado entre 2  
Begrenzter Raum zwischen 2

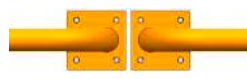

**OPTION** ◦ **OPTIONAL** ◦ **OPCIÓN** ◦ **OPTIONAL**



BAR FIX 1 SB



BAR FIX 8 SB



BAR FIX 304 SB

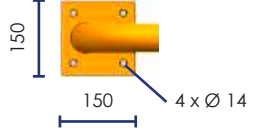

Ne pas installer en milieu salin ou Hydrocarbure. Nous consulter.  
Do not install in saline or Oil environment. Contact us.  
No lo instale en un ambiente salino o hidrocarburo. Consultéenos.  
Soll nicht in Salz oder Kohlenstoff Umgebung installiert werden, /uns Konsultieren.

Sauf ◦ Except ◦ Salvo ◦ Nur







**BAS**

**BARRIÈRE À SCELLER** ◦ **BARRIERS TO EMBED**  
**BARRERAS PARA EMPOTRAR** ◦ **RAMMSCHUTZBÜGEL ZUM EINBETONIEREN**



Code		
BAS 405 NJ		4,00
BAS 405 GAL		4,00
BAS 400 NJ		5,00
BAS 400 GAL		5,00
BAS 2930 JA		16,00

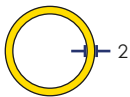
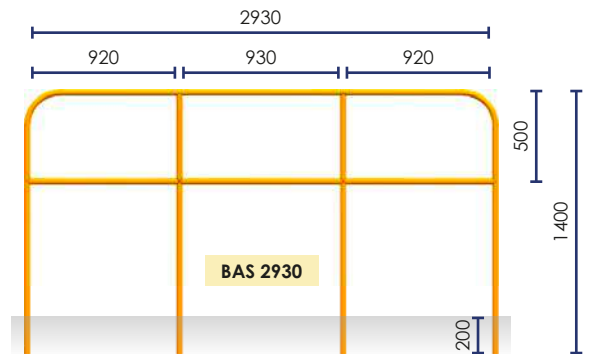
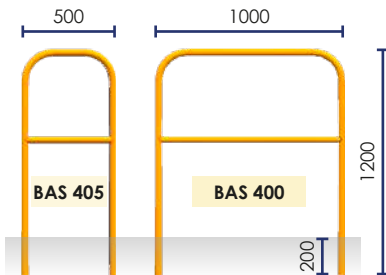

Code		
BAS 600 RB		8,50
BAS 600 NJ		8,50
BAS 600 V		8,50
BAS 600 GAL		8,50
BAS 615 GAL		11,80
BAS 620 RB		12,70
BAS 620 NJ		12,70
BAS 620 J		12,70
BAS 620 GAL		12,70

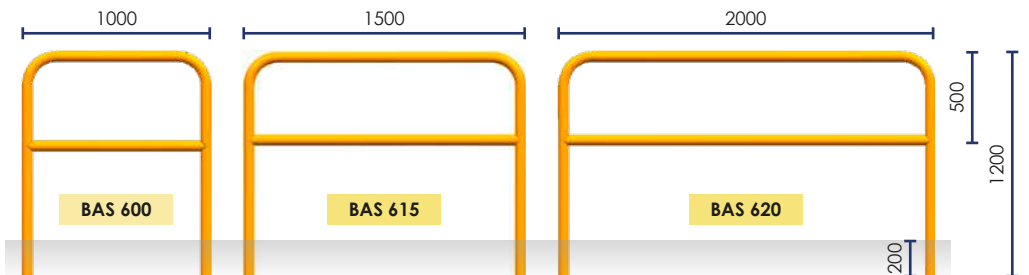

**PEINTURE ÉPOXY**  
**POWDER PAINTING**  
**PINTURA EPOXICA**  
**EPOXY FARBE**



Ne pas installer en milieu salin ou Hydrocarbure. Nous consulter.  
 Do not install in saline or Oil environment. Contact us.  
 No lo instale en un ambiente salino o hidrocarburo. Consúltenos.  
 Soll nicht in Salz oder Kohlenstoff Umgebung installiert werden,  
 /uns Konsultieren.

Sauf ◦ Except ◦ Salvo ◦ Nur







**BAS**

**BASOL**

**BBASE**

**BAS 40 SIM GAL**

**BAS SIM GAL**

**BAS 40 DOU GAL**

**BAS DOU GAL**

**BAS 60 SIM GAL**

**BAS 60 DOU GAL**

**BASOL 40 GAL**

**BASOL GAL**

**BASOL 40 DO GAL**

**BASOL DO GAL**

**BASOL 60 GAL**

**BASOL 60 DO GAL**

**BBASE 40**

**BBASE**

**BBASE 40 DOU**

**BBASE DOU**

**BBASE 60**

**BBASE 60 DOU**





BTC

## BARRIÈRE MODULAIRE

MODULAR BARRIER ◦ BARRERA MODULAR ◦ MODULARE ABSPERRUNGEN



- Les barrières modulaires permettent de disposer d'un équipement adapté et sur-mesure pour assurer la sécurité dans un environnement industriel
- Retrouvez tous nos éléments pour confectionner vous-même vos barrières ou retrouvez des configurations préconçues
- Modular barriers allow you to have the right equipment to ensure the safety on an industrial environment.
- Find all our elements to make your own gates or find pre-designed configurations.
- Las barreras modulares permiten tener el equipo adecuado para garantizar la seguridad en un entorno industrial.
- Encuentre todos nuestros productos para hacer sus propias barreras o consulte las configuraciones prediseñadas.
- Modulare Absperrungen sorgen für eine geeignete Ausstattung und Sicherheit der Industrie.
- Finden Sie alle unsere Elemente, um Ihre Absperrungen selbst zu bauen oder in vordefinierte Konfigurationen zu wählen.

Code	
BTC 40 DE	2,65
BTC 40 AN	3,20
BTC 40 AN 120	3,20
BTC 40 AN 150	3,20
BTC 40 DO	3,21
BTC 40 TR	3,60
BTC 40 POR	6,70
BTC 40 STOP	1,80
BTC 40 BAT	7,40
BT 40 MFL	0,80
BT 40 MML	0,82
BT 40 MFS	0,25
BT 40 MMS	0,30



Code			
SAS 150	Sas acier ◦ Combination Configuración ◦ Kombination	1,5 x 1,5 m	32
SAS 315	Sas acier ◦ Combination Configuración ◦ Kombination	3 x 1,5 m	41



Ne pas installer en milieu salin ou Hydrocarbure. Nous consulter.  
Do not install in saline or Oil environment. Contact us.  
No lo instale en un ambiente salino o hidrocarburo. Consúltenos.  
Soll nicht in Salz oder Kohlenstoff Umgebung installiert werden,  
/uns Konsultieren.



# BARRIÈRE MODULAIRE

MODULAR BARRIER ◦ BARRERA MODULAR ◦ MODULARE ABSPERRUNGEN

Créa Luxe.fr

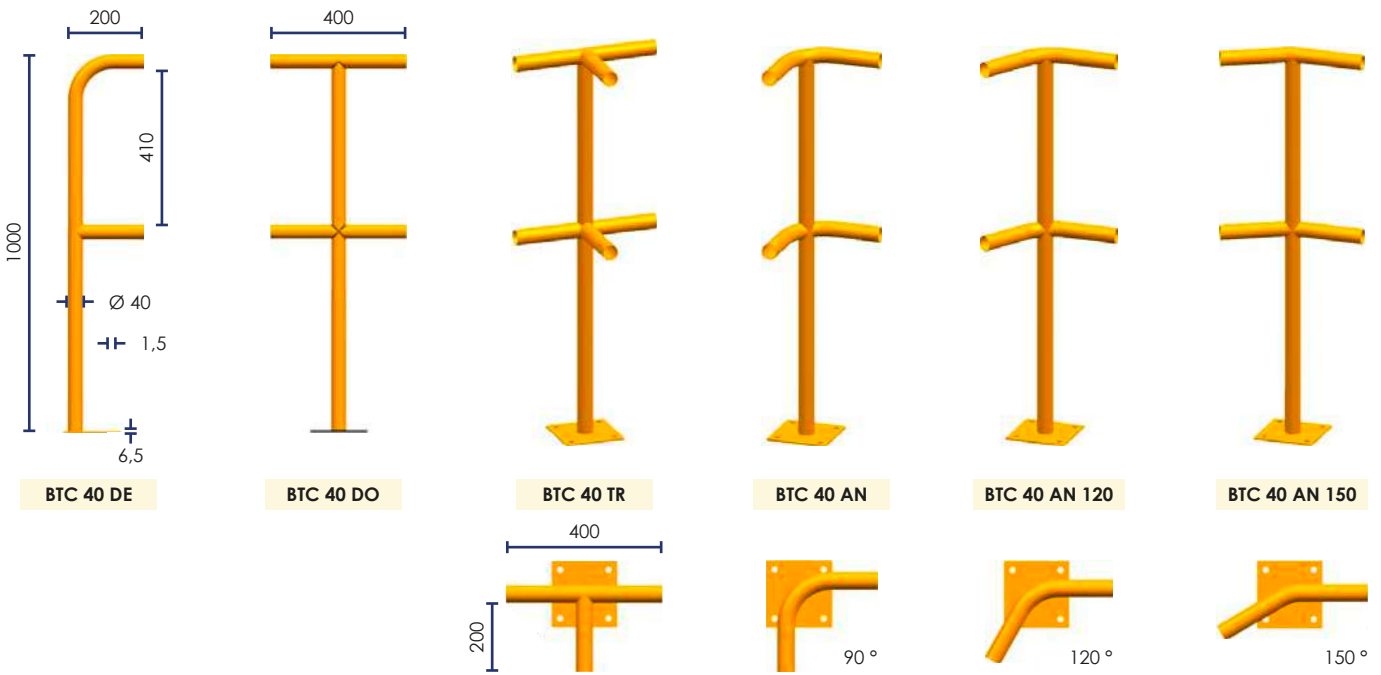

## LONGUEUR ◦ EXTENSIONS ◦ EXTENSIONES ◦ VERLÄNGERUNG

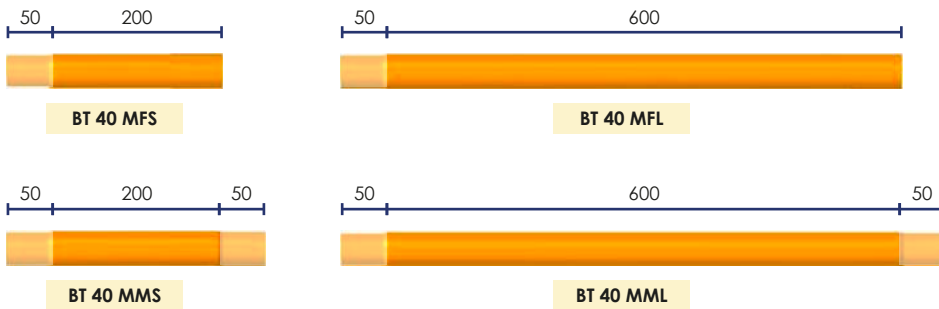

## PORTES ◦ DOORS ◦ PUERTAS ◦ TÜREN

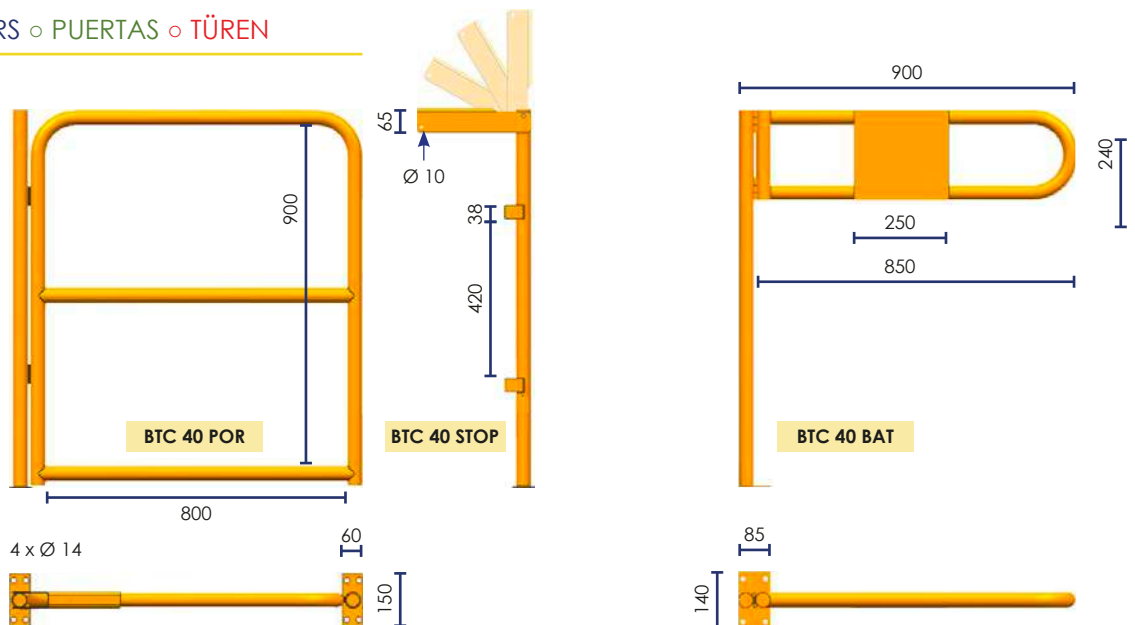

### OPTION ◦ OPTIONAL ◦ OPCIÓN ◦ OPTIONAL

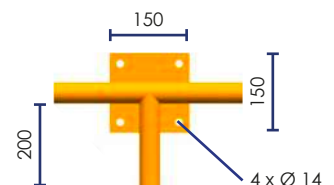
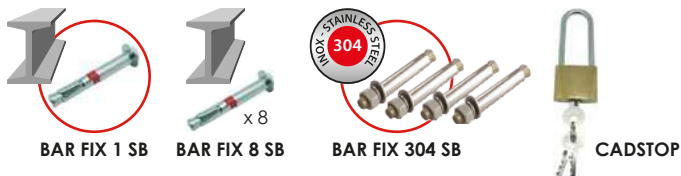





# BARP

## ARCEAU ANTI-ENCASTREMENT HOOP PROTECTION GUARD WITH PLATE ◦ BARRERAS PARAGOLPES SCHUTZBÜGEL MIT HOHEM WIDERSTAND

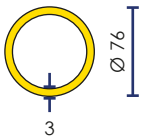

Code		kg
BARP 3575 NJ		9,50
BARP 3510 NJ		11,10
BARP 6075 NJ		13,00
BARP 6010 NJ		15,50

BARP 3575 NJ



BARP 6075 NJ

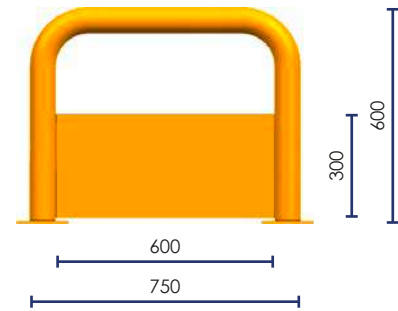

BARP 3510 NJ



BARP 6010 NJ

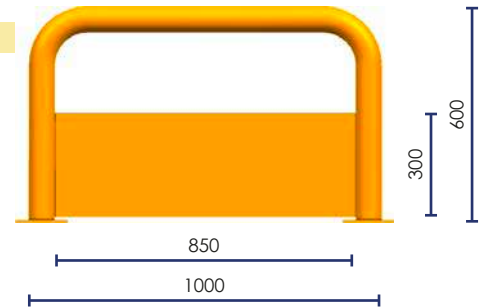

Bords arrondis  
Rounded edges  
Bordes redondeados  
Abgerundete Ecken



OPTION ◦ OPTIONAL ◦ OPCIÓN ◦ OPTIONAL



BAR FIX 1 SB



BAR FIX 8 SB



BAR FIX 304 SB

160 x 140

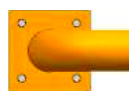

4 x Ø 14



Ne pas installer en milieu salin ou Hydrocarbure.  
Nous consulter.  
Do not install in saline or Oil environment.  
Contact us.  
No lo instale en un ambiente salino o hidrocarburo.  
Consúltenos.  
Soll nicht in Salz oder Kohlenstoff Umgebung  
installiert werden, /uns Konsultieren.





**ARCEAU HAUTE RÉSISTANCE** ◦ **HEAVY DUTY PROTECTION GUARDS**  
**BARRERAS DE PROTECCIÓN ALTA RESISTENCIA**  
**SCHUTZBÜGEL MIT HOHEM WIDERSTAND**

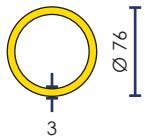

Code		kg
BAR 37 NJ		6,50
BAR 3575 NJ		7,50
BAR 3510 NJ		9,00
BAR 6075 NJ		10,00
BAR 6010 NJ		11,50
BAR 1275 NJ		15,00
BAR 1210 NJ	16,50	

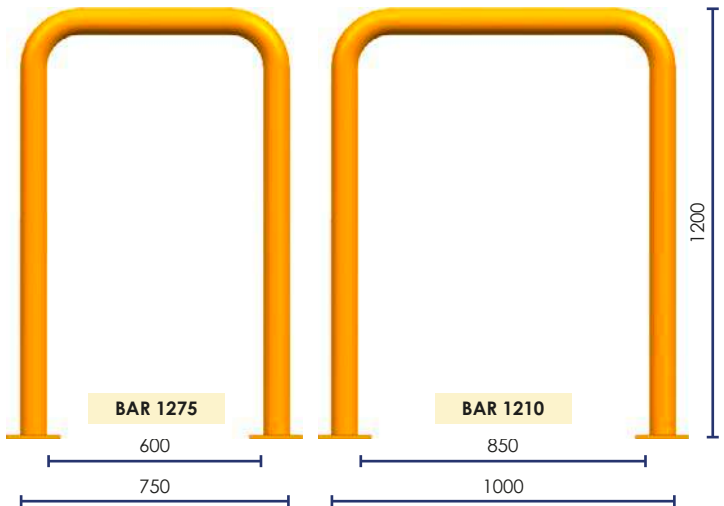
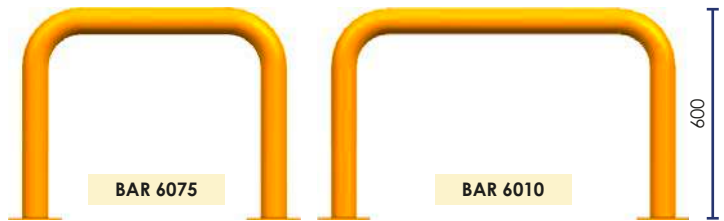

Code		kg	
BAR 37 GAL		6,50	<b>GALVA</b>
BAR 3575 GAL		7,50	
BAR 3510 GAL		9,00	
BAR 6075 GAL		10,00	
BAR 6010 GAL		11,50	
BAR 1275 GAL		15,00	
BAR 1210 GAL	16,50		

Bords arrondis  
 Rounded edges  
 Bordos redondeados  
 Abgerundete Ecken



**OPTION** ◦ **OPTIONAL** ◦ **OPCIÓN** ◦ **OPTIONAL**



BAR FIX 1 SB



BAR FIX 8 SB



BAR FIX 304 SB

160 x 140

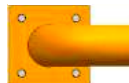

4 x Ø 14



Ne pas installer en milieu salin ou Hydrocarbure. Nous consulter.  
 Do not install in saline or Oil environment. Contact us.  
 No lo instale en un ambiente salino o hidrocarburo. Consúltanos.  
 Soll nicht in Salz oder Kohlenstoff Umgebung installiert werden, /uns Konsultieren.

Sauf ◦ Except ◦ Salvo ◦ Nur







# ÉTRIER ET PROTECTION DE COLONNE

COLUMN AND PIPE PROTECTORS ◦ PROTECCIÓN DE COLUMNAS ◦ SCHUTZBÜGEL



Ø 60 mm GALVA



POT 757 GAL 12,00

POTS 600 GAL 9,50

Ø 40 mm

POT 76 R 3,50

Ø 50 mm PCS 4050 RO 8,50

Ø 60 mm PCS 10060 NJ 8,50

OPTION ◦ OPTIONAL ◦ OPCIÓN ◦ OPTIONAL

BAR FIX 1 SB BAR FIX 8 SB BAR FIX 304 SB

PEINTURE ÉPOXY  
POWDER PAINTING  
PINTURA EPOXICA  
EPOXY FARBE





Créa Luxe.fr

**BARA**

**PROTECTION D'ANGLE** ◦ **CORNER PROTECTION GUARDS**  
**ESTRIBOS DE PROTECCIÓN** ◦ **SCHUTZBÜGEL**



Ø 76 mm

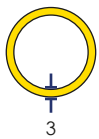

Code		
BARA 3566 NJ		12,00
BARA 6066 NJ		15,20
BARA 1266 NJ		22,80

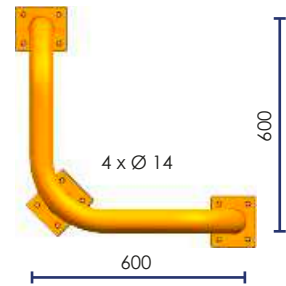

Code		
BARA 3566 GAL		12,00
BARA 6066 GAL		15,20
BARA 1266 GAL		22,80



Code		
PRF 700 NJ		19

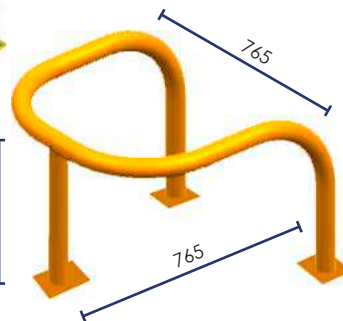

Code		
PRF 700 GAL		19



**OPTION** ◦ **OPTIONAL** ◦ **OPCIÓN** ◦ **OPTIONAL**



BAR FIX 1 SB



BAR FIX 304 SB

160 x 140

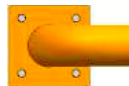

4 x Ø 14



Ne pas installer en milieu salin ou Hydrocarbure. Nous consulter.  
 Do not install in saline or Oil environment. Contact us.  
 No lo instale en un ambiente salino o hidrocarburo. Consultenos.  
 Soll nicht in Salz oder Kohlenstoff Umgebung installiert werden, /uns Konsultieren.

Sauf ◦ Except ◦ Salvo ◦ Nur







# PARK

## BUTÉE DE PROTECTION ANTI-COLLISION BAR BARRA PROTECCIÓN ACERO RAMMSCHUTZBÜGEL-BALKEN



PEINTURE ÉPOXY  
POWDER PAINTING  
PINTURA EPOXICA  
EPOXY FARBE



Code			
PARK 6565 NJ	6		4,80
PARK 400 NJ	4		3,50
PARK 800 NJ	4		4,50
PARK 1200 NJ	4		6,80



PARK 400 NJ

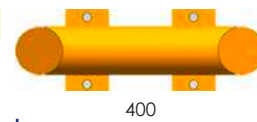

PARK 800 NJ

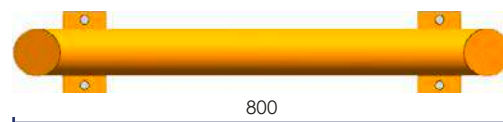

PARK 1200 NJ

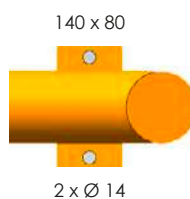
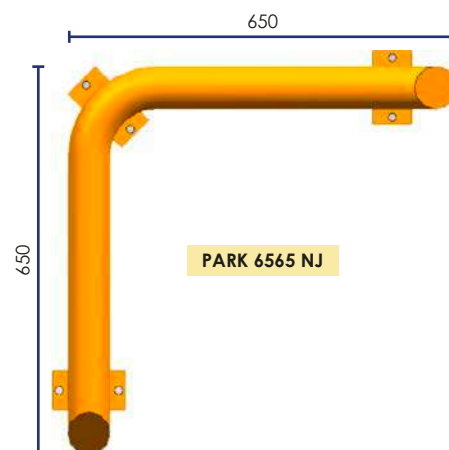
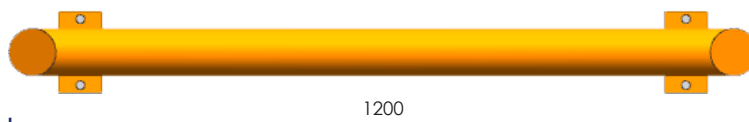

Ne pas installer en milieu salin ou Hydrocarbure. Nous consulter.  
Do not install in saline or Oil environment. Contact us.  
No lo instale en un ambiente salino o hidrocarburo. Consúltenos.  
Soll nicht in Salz oder Kohlenstoff Umgebung installiert werden, /uns Konsultieren.

OPTION ○ OPTIONAL ○ OPCIÓN ○ OPTIONAL



BAR FIX 1 SB



BAR FIX 304 SB





PARKSTEEL

**BUTÉE DE PROTECTION**  
**ANTI-COLLISION BAR**  
**BARRA PROTECCIÓN ACERO**  
**EINSTELLBARE SCHUTZBÜGEL**



PEINTURE ÉPOXY  
 POWDER PAINTING  
 PINTURA EPOXICA  
 EPOXY FARBE



Code		
PARKSTEEL 80	4	6,70
PARKSTEEL 120	4	8,40
PARKSTEEL 200	6	14,00
PARKORNER	4	5,00

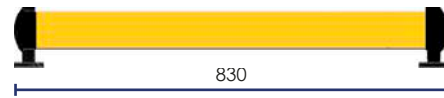

PARKSTEEL 80

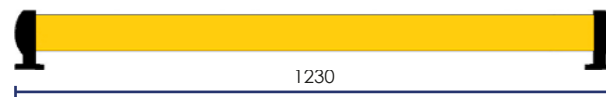

PARKSTEEL 120

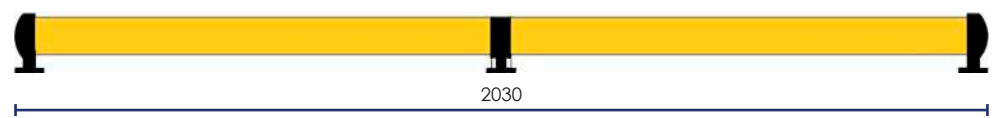

PARKSTEEL 200



Peut être coupé et ajusté à la longueur désirée.  
 Can be cut to the requested length.  
 Se puede cortar y ajustar a la longitud deseada.  
 Kann geschnitten und auf die gewünschte Länge angepasst werden..

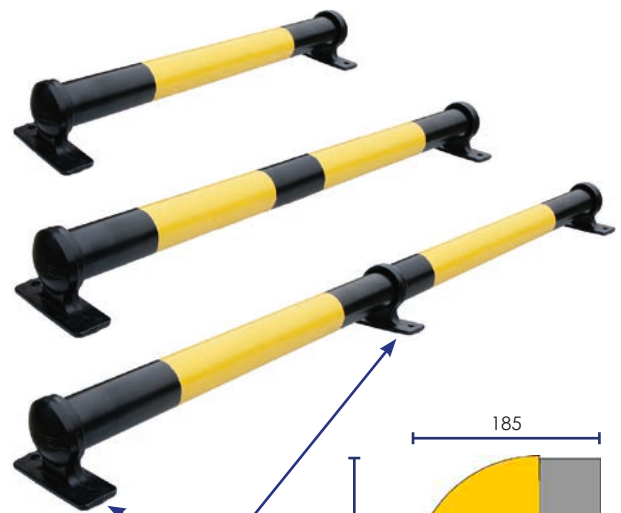

FORGE D'ACIER  
 IRON CAST  
 ACERO FUNDIDO  
 STAHLGUSS



OPTION  
 OPTIONAL  
 OPCIÓN  
 OPTIONAL



FSAFE 4 SB  
 Ø 12 x 120

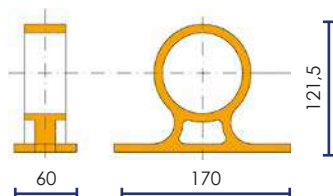

Ne pas installer en milieu salin ou Hydrocarbure.  
 Nous consulter.  
 Do not install in saline or Oil environment.  
 Contact us.  
 No lo instale en un ambiente salino o hidrocarburo.  
 Consúltenos.  
 Soll nicht in Salz oder Kohlenstoff Umgebung installiert werden. /uns Konsultieren.









## POTEAUX INOX

STAINLESS STEEL POSTS ◦ POSTES DE ACERO INOXIDABLE ◦ EDELSTAHLPFOSTEN



Code	∅ mm			kg
POT 89 316				3,90
POTS 89 316	89	∅ 170		5,00
POT BOX 89			135 x 135 H 300	4,50
POT 159 316				11,50
POTS 159 316	159	∅ 240		12,20
POT BOX 159			175 x 145 H 300	11,00

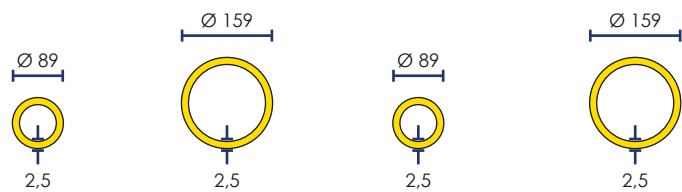

Fourni  
Supplied  
Includo  
Inklusive



POTS 89 316



POTS 159 316



POT 89 316

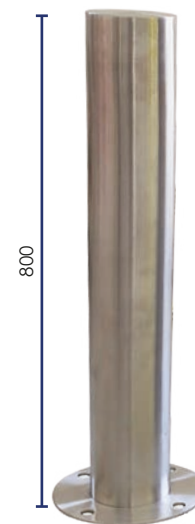

POT 159 316

OPTION ◦ OPTIONAL ◦ OPCIÓN ◦ OPTIONAL



BAR FIX 304 SB



POT BOX 89



POT BOX 159



- ▶ POT 2 RESB
- ▶ POT 2 ORSB
- ▶ POT 2 WHSB
- ▶ POT 2 BUSB
- ▶ POT 2 VERSB

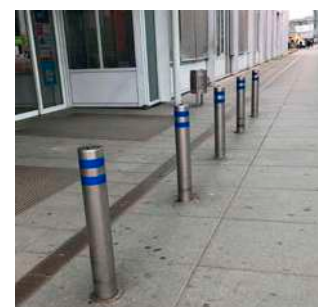



# POT LED

## POTEAUX ACIER À LED

LED STEEL POSTS ◦ POSTES CON LED ◦ STAHLROHRPOLLER MIT LED



Code	☀️	∅ Led	⚖️
POT 90 LED RB	9	5	8
POT 160 LED RB	18	5	13

- Tube en ACIER
- Batterie lithium
- Intensité 6000 mcd
- Panneau solaire - IP65
- Visibilité 500 m
- Température -10 / +45 °C
- Durée de vie de la batterie : 3 ans
- 8h de soleil = 10 - 12 h d'autonomie
- STEEL tube
- Lithium battery
- Intensity 6000 mcd
- Solar glass panel - IP65 RATING
- Visibility 500m
- Temperature range -10/+45°.
- Battery life: 3 years
- 8 hours of sunlight = 10 - 12 hours autonomy
- Tubo de acero
- Bateria de Litio
- Intensidad 6000 mcd
- Panel solar - IP65
- Visibilidad 500 m
- Temperatura -10 / +45 °C
- Duración de la batería: 3 años
- 8 horas de luz = 10-12 horas de autonomía
- Rohr aus STAHL
- Lithium Akku
- Intensität 6000 mcd
- Solarmodul - IP65
- Sichtbarkeit 500m
- Temperatur -10/+45°
- Batterielebensdauer: 3 Jahre
- 8h Sonne = 10h - 12h Laufzeit

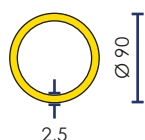

POT 90 LED RB

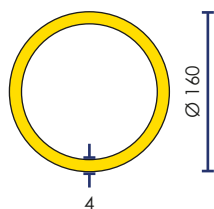

POT 160 LED RB

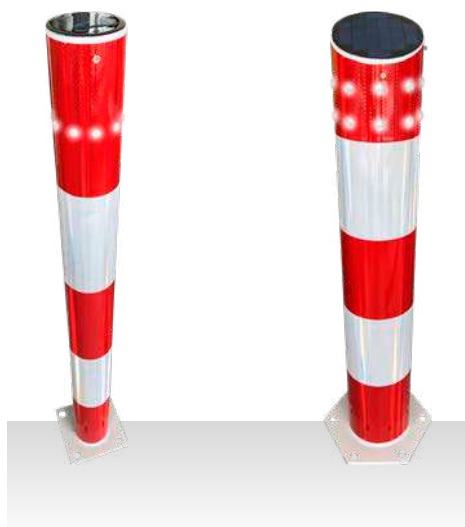

Clignote uniquement la nuit  
Flashes only at night  
Parpadeos sólo de noche  
Blinkt nur in der Nacht



4 x ∅ 14  
200 x 200



6 x ∅ 14  
150



Ne pas installer en milieu salin ou Hydrocarbure. Nous consulter.  
Do not install in saline or Oil environment. Contact us.  
No lo instale en un ambiente salino o hidrocarburo. Consúltanos.  
Soll nicht in Salz oder Kohlenstoff Umgebung installiert werden, /uns Konsultieren.

OPTION ◦ OPTIONAL ◦ OPCIÓN ◦ OPTIONAL



BAR FIX 1 SB



BAR FIX 304 SB





# POT / POTS

## POTEAUX ACIER

STEEL POTS ◦ POSTES DE ACERO ◦ STAHLPFOSTEN



Code	Ø mm	Color	kg
POT 800 NJ	90	Black/Yellow	7.30
POT 800 RB		Red/White	
POT 800 GAL		Grey	
POTS 800 NJ		Black/Yellow	5.30
POTS 800 RB		Red/White	
POTS 800 GAL		Grey	



Code	Ø mm	Color	kg
POT 90 NJ	90	Black/Yellow	10.00
POT 90 GAL	90	Grey	10.00
POT 159 NJ	159	Black/Yellow	21.00
POT 159 GAL	159	Grey	21.00
POT 273 NJ	273	Black/Yellow	48.00
POT 273 GAL	273	Grey	48.00
POT 1616 J	159	Yellow	18.20

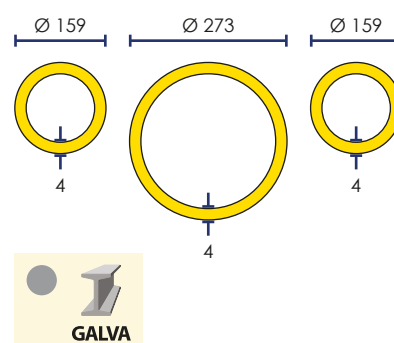

1550

1200

**POT 800 NJ**   **POT 800 RB**   **POT 800 GAL**   **POTS 800 NJ**   **POTS 800 RB**   **POT 90 NJ**   **POT 159 NJ**   **POT 273 NJ**   **POT 1616 J**

Base plates: 200 x 200 4 x Ø 14, 285 x 145 6 x Ø 14, 430 x 205 6 x Ø 14, 285 x 8 x Ø 14.

OPTION ◦ OPTIONAL ◦ OPCIÓN ◦ OPTIONAL

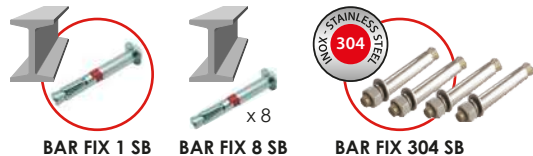

Ne pas installer en milieu salin ou Hydrocrabure. Nous consulter.  
 Do not install in saline or Oil environment. Contact us.  
 No lo instale en un ambiente salino o hidocraburo. Consúltenos.  
 Soll nicht in Salz oder Kohlenstoff Umgebung installiert werden.  
 /uns Konsultieren.

Sauf ◦ Except ◦ Salvo ◦ Nur











TPX

**ARCEAU FLEXIBLE À MÉMOIRE DE FORME**  
**FLEXIBLE HOOP** ◦ **BARRERA DE PROTECCIÓN FLEXIBLE**  
**RAMMSCHUTZBÜGEL MIT FORMGEDÄCHTNIS**

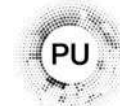

Code		
TPX 1235 NJ	350 x 1200 x 150	8,5
TPX 1275 NJ	750 x 1200 x 150	10,2
TPX 12100 NJ	1000 x 1200 x 150	11,8

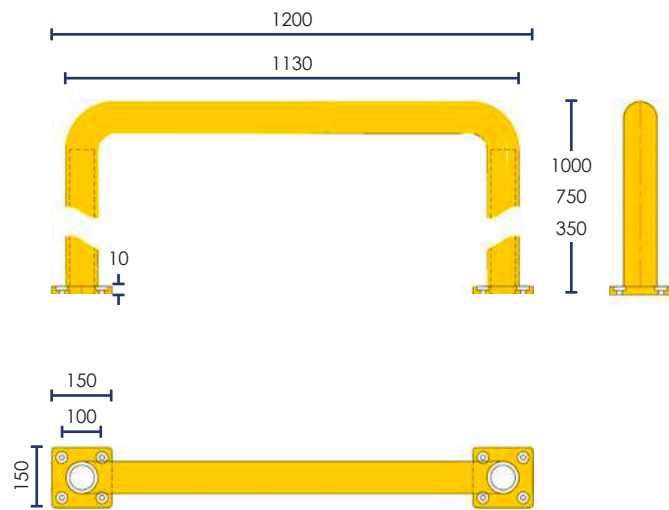
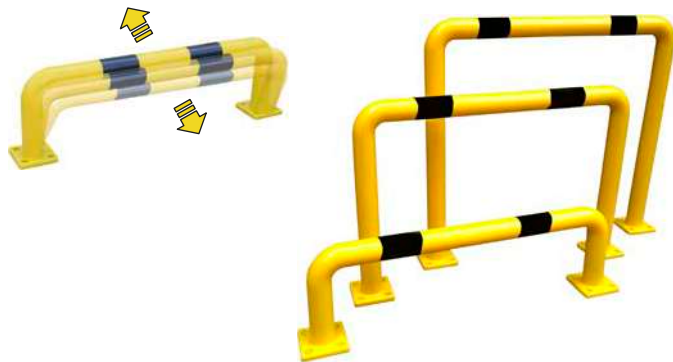

**BUTÉE FLEXIBLE À MÉMOIRE DE FORME**  
**FLEXIBLE PROTECTION BARS** ◦ **TOPES DE PROTECCIÓN FLEXIBLES**  
**FLEXIBEL RAMMSCHUTZBALKEN MIT FORMGEDÄCHTNIS**

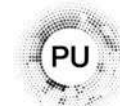

Code		
TPX 800 NJ	798 x 150 x 120	2,4
TPX 1200 NJ	1180 x 150 x 120	4,3
TPX 2000 NJ	1998 x 150 x 120	7,2

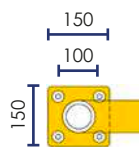
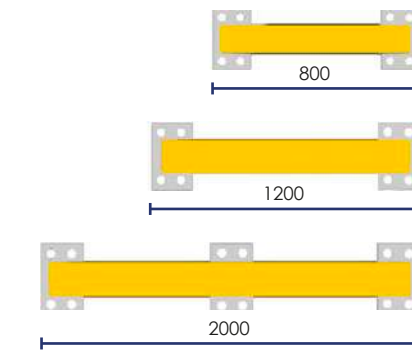

Capuchons ◦ Caps  
 Tapas ◦ Kappen

OPTION  
 OPTIONAL  
 OPCIÓN  
 OPTIONAL



TPU FIX 1 SB  
 Ø 12 x 80

\* < 20 °C - Nous consulter ◦ Ask us ◦ Consultarnos ◦ uns konsultieren





TPX

**POTEAUX FLEXIBLES À MÉMOIRE DE FORME**  
**FLEXIBLE BOLLARDS** ◦ **POSTES FLEXIBLES**  
**RAMMSCHUTZPOLLER MIT FORMGEDÄCHTNIS**

Ø 80 mm

PU

+ 50 °C  
- 20 °C\*

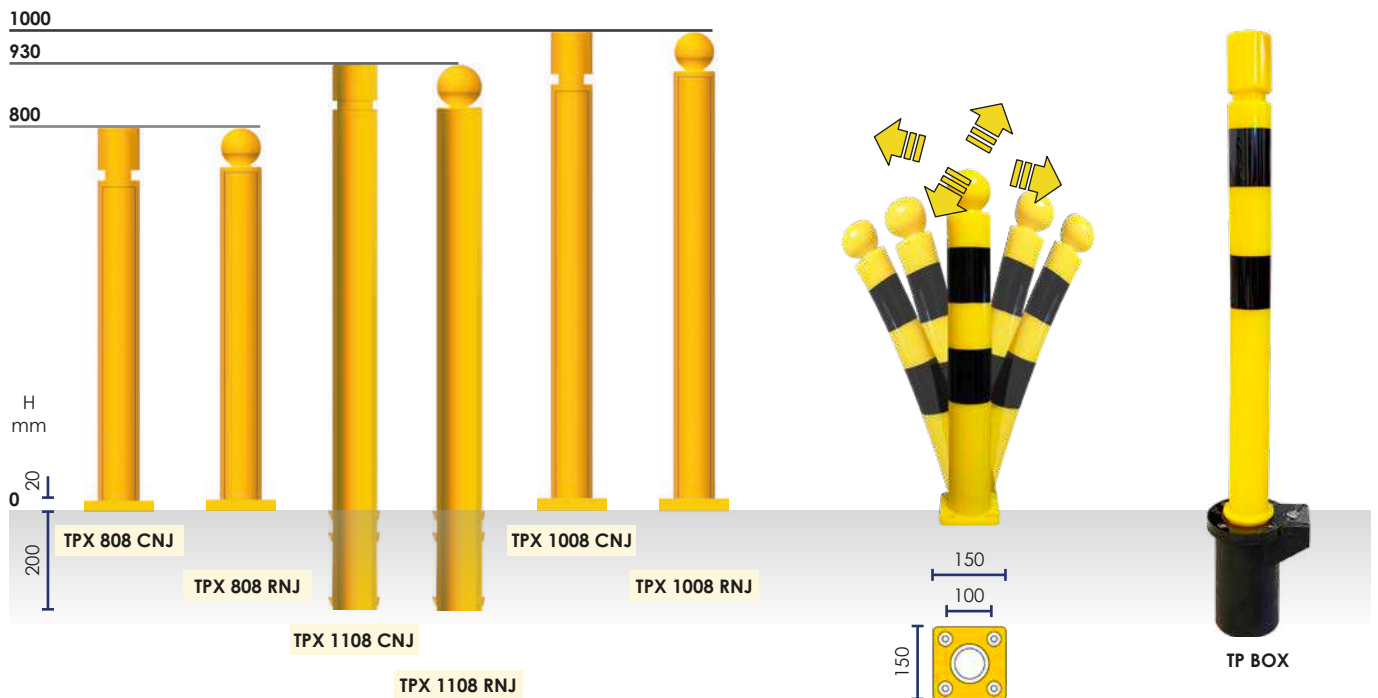

Code		
TPX 808 CNJ		3,00
TPX 808 RNJ		3,00
TPX 1108 CNJ		3,00
TPX 1108 RNJ		3,00
TPX 1008 CNJ		2,50
TPX 1008 RNJ		2,50

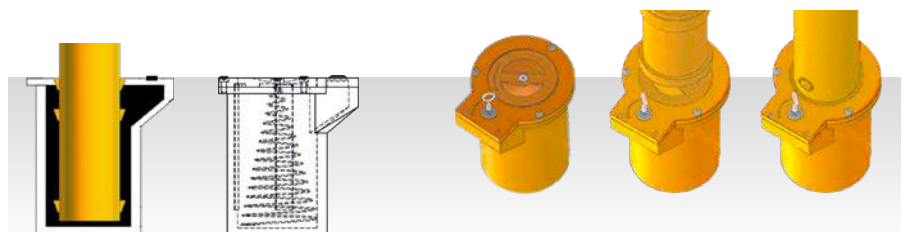

OPTION ◦ OPTIONAL ◦ OPCIÓN ◦ OPTIONAL



Capuchons ◦ Caps  
Tapas ◦ Kappen

TPU FIX 1 SB  
Ø 12 x 80

TPZ RING

TP BOX 80

**BREVETÉ**  
PATENTED  
PATENTADO

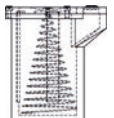

\* < 20 °C - Nous consulter ◦ Ask us ◦ Consultarnos ◦ uns konsultieren





# POTEAUX FLEXIBLES À MÉMOIRE DE FORME

FLEXIBLE BOLLARDS ◦ POSTES FLEXIBLES

RAMMSCHUTZPOLLER MIT FORMGEDÄCHTNIS

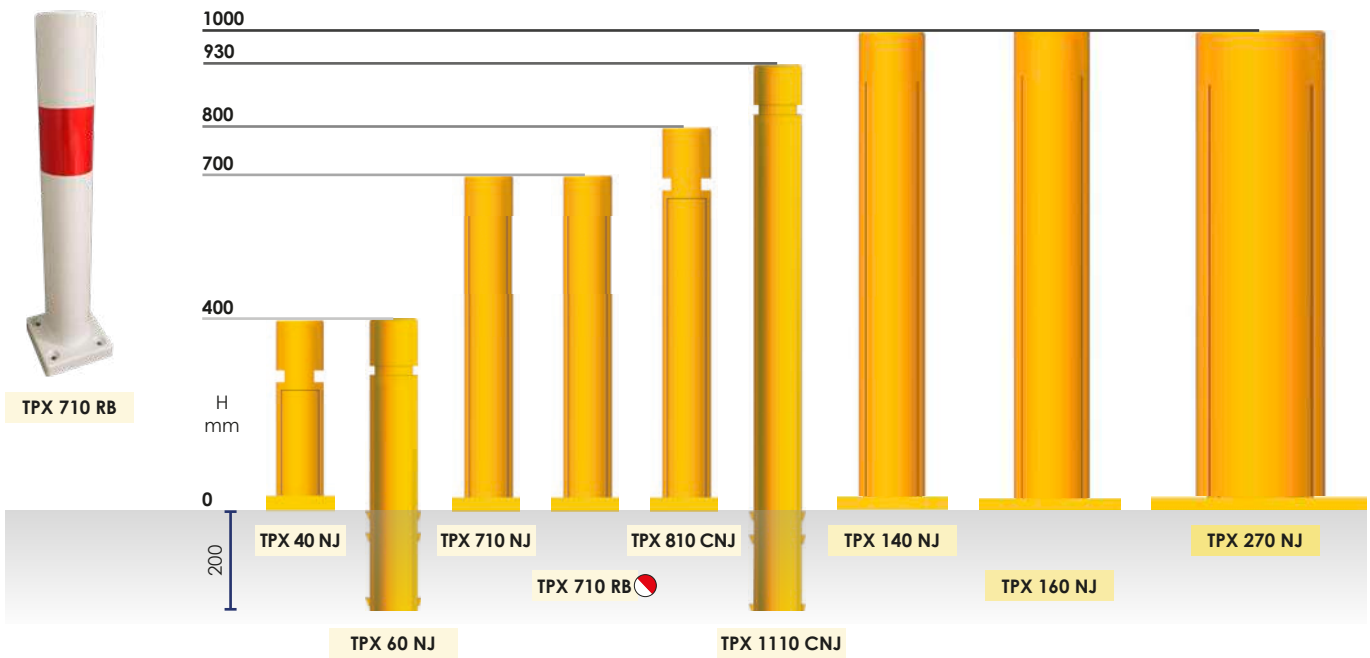
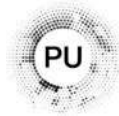

Code	Ø mm	Color	kg
TPX 40 NJ	100	Yellow/Black	2,00
TPX 60 NJ		Yellow/Black	2,40
TPX 710 NJ		Yellow/Black	2,50
TPX 710 RB		Red/White	2,50
TPX 810 CNJ		Yellow/Black	3,50
TPX 1110 CNJ		Yellow/Black	2,90
TPX 140 NJ	140	Yellow/Black	7,00
TPX 160 NJ	160	Yellow/Black	7,00
TPX 270 NJ	270	Yellow/Black	10,50

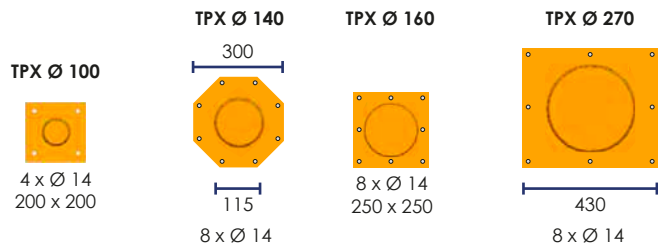

OPTION ◦ OPTIONAL ◦ OPCIÓN ◦ OPTIONAL



TPU FIX 1 SB  
Ø 12 x 80



TPU RING



TP BOX 100

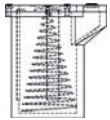

Capuchons ◦ Caps  
Tapas ◦ Kappen

\* < 20 °C - Nous consulter ◦ Ask us ◦ Consultarnos ◦ uns konsultieren





# MOUSSE DE PROTECTION

## FOAM PROTECTION ◦ PROTECTORES DE ESPUMA

### SCHAUMSTOFF SCHUTZ

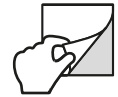

Copolymère d'éthylène et d'acétate de vinyle à cellules fermées extrêmement fines, impénétrables aux liquides.

Extremely fine closed cell of ethylene vinyl acetate copolymer, impenetrable to liquid.

Copolímero de etileno-acetato de vinilo extremadamente fino, impenetrable a los líquidos.

Ethylen-Vinylacetat, thermoplastisch. Ausgezeichnete Beständigkeit gegen Mineralölprodukte und Lösungsmittel.



Caoutchouc nitrile, copolymère acrylonitrile-butadiène. Excellente résistance aux produits pétroliers et aux solvants. Densité 105 kg/m<sup>3</sup>.

Nitrile rubber, acrylonitrile butadiene rubber is a synthetic rubber. Oil and grease resistant.

La goma de nitrilo es un copolímero de goma sintética. Más resistente a aceite y ácidos que el caucho natural. Densidad 105 kg / m<sup>3</sup>.

Nitrilkautschuk, Acrylnitril-Butadien-Copolymer mit ausgezeichneter Beständigkeit gegen Erdölprodukte und Lösungsmittel.

Dichte 105 kg / m<sup>3</sup>.

## PROTECTIONS DE PROFILÉS ET D'ARÊTES ◦ RACKS AND EDGES PROTECTORS

### PROTECCIONES PARA RACKS Y VIGAS ◦ PROFIL- UND KANTENSCHUTZ

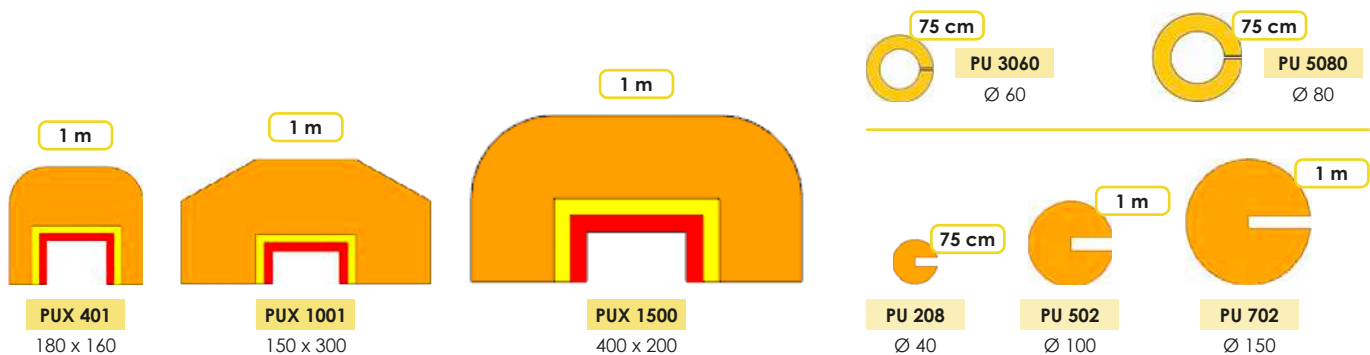

## PROTECTIONS D'ANGLES ◦ CORNER PROTECTION

### PROTECCIONES DE ESQUINAS ◦ ECKENSCHUTZ

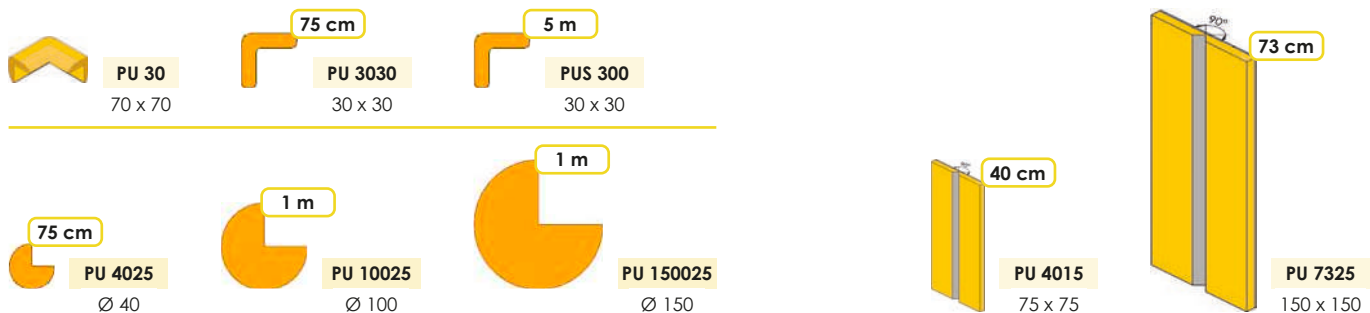

## PROTECTIONS DROITES ◦ WALL PROTECTION

### PROTECCIONES RECTAS ◦ WANDSCHUTZ

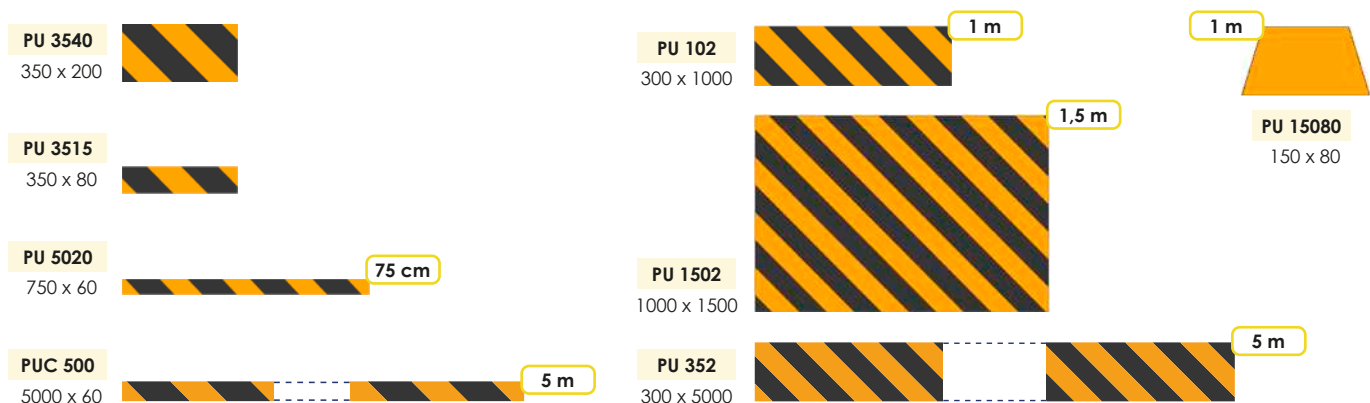





PUX

**PROTECTION DE PROFILÉ**  
**RACK PROTECTOR** ◦ **PROTECCIÓN DE RACK**  
**PROFILSCHUTZ**



Code			
PUX 401		EVA	1,45

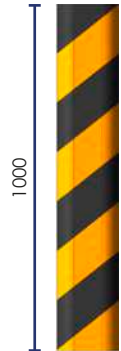
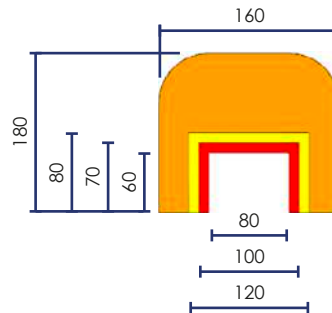
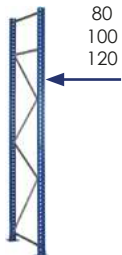

Code			
PUX 1001		EVA	1,65

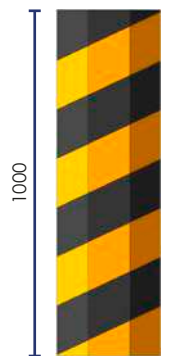
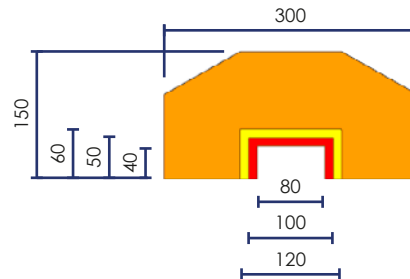
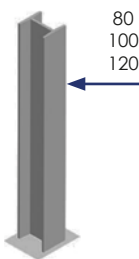

Code			
PUX 1500		EVA	1,65

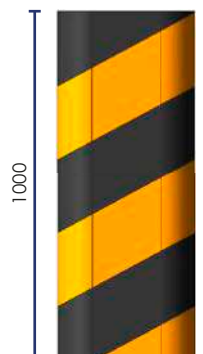
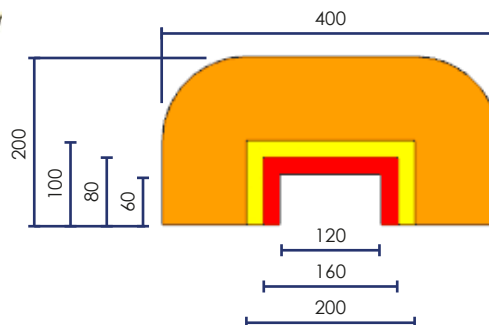



## PROTECTION D'ARÊTE

EDGE PROTECTOR ◦ PROTECCIÓN DE VIGAS  
KANTENSCHUTZ



Code				
PU 208 RB		EVA	0,10	
PU 208 NJ		EVA	0,10	75 cm
PU 208 WH		EVA	0,10	
PU 502		EVA	0,25	
PU 702		EVA	0,60	1 m

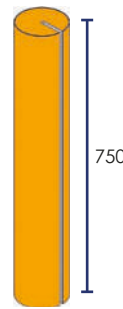

PU 208

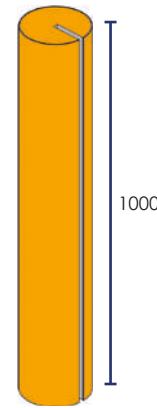

PU 502

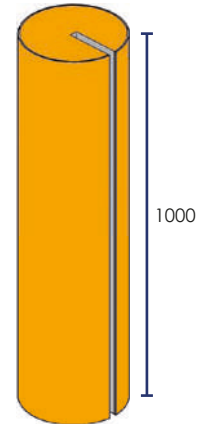
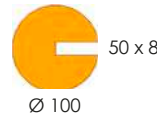

PU 702

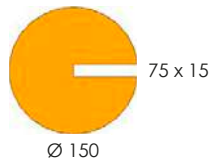

## PROTECTION DE TUBES ET TUYAUX

PIPE PROTECTOR ◦ PROTECCIÓN DE TUBOS  
SCHUTZ VON ROHREN UND LEITUNGEN

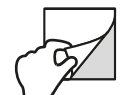

Code				
PU 3060 NJ		EVA	0,2	75 cm
PU 5080 NJ		EVA	0,3	



On referme l'adhésif sur le tube.  
Tape to close over a tube.  
Se cierra el adhesivo sobre el tubo.  
Der Klebstoff wird auf der Schlauch Verschlossen.

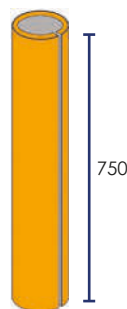

PU 3060

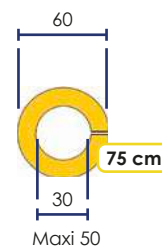

PU 5080

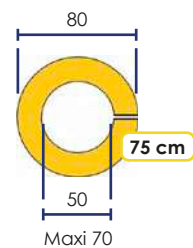





PU

## PROTECTION D'ANGLE CORNER PROTECTOR ◦ PROTECCIÓN DE ESQUINAS ECKENSCHUTZ



Code				
PU 4025 RB		EVA	0,10	
PU 4025 NJ		EVA	0,10	75 cm
PU 4025 WH		EVA	0,10	
PU 10025		EVA	0,20	1 m
PU 150025		EVA	0,50	

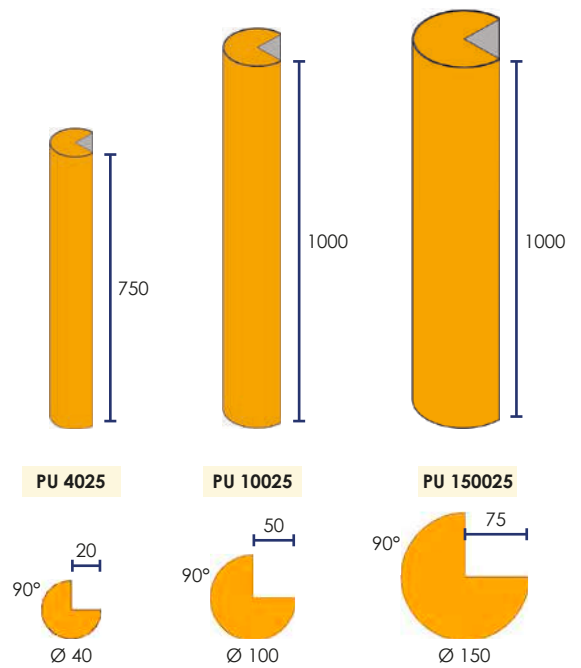

Code				
PU 4015 RB		EVA	0,04	40 cm
PU 4015 NJ		EVA	0,04	
PU 7325 RB		EVA	0,08	73 cm
PU 7325 NJ		EVA	0,08	

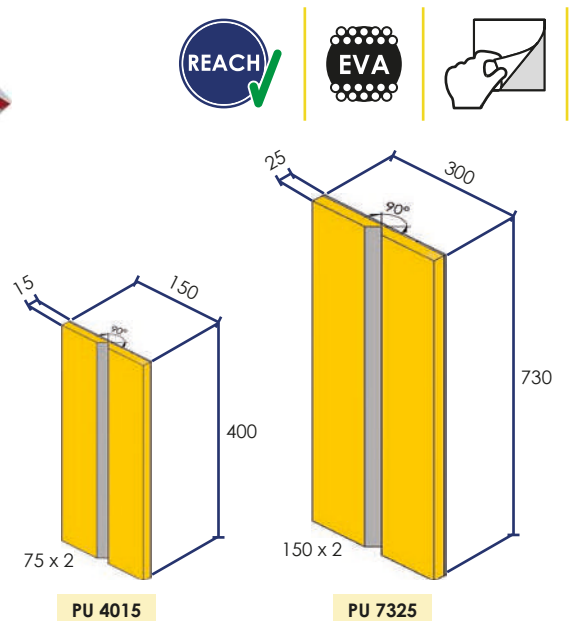



PU

**PROTECTION D'ANGLE**  
**CORNER PROTECTION** ◦ **PROTECCIÓN DE ANGULOS**  
**ECKENSCHUTZ**

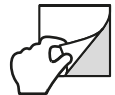

Code			
PU 30 RB *		NBR	0,015
PU 30 NJ		NBR	0,015
PU 30 WH		NBR	0,015

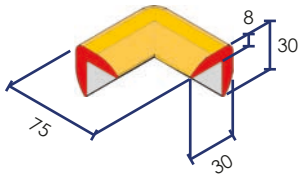

Code			
PU 3030 RB *		NBR	0,08
PU 3030 NJ		NBR	0,08
PU 3030 WH		NBR	0,08
PUS 300 RB *		NBR	0,55
PUS 300 NJ		NBR	0,55

75 cm

5 m



PU 3030



PUS 300

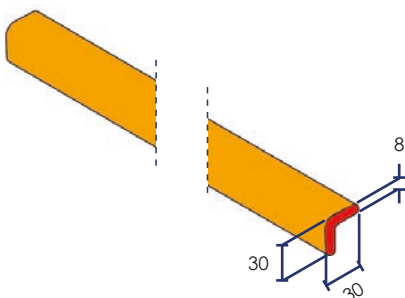

\* Jusqu'à épuisement du stock ◦ While stock lasts ◦ Hasta agotar existencias ◦ Solange der Vorrat reicht





# PU 15080

## BUTOIR BUMPER ◦ TOPE DE PROTECCIÓN STOBSTANGE



Code			
PU 15080		EVA	0,30

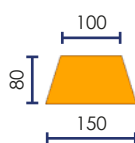

## PROTECTIONS DROITES WALL PROTECTOR ◦ PROTECCIÓN RECTA WANDSCHUTZ



Code			
PU 3515 RB		EVA	0,07
PU 3515 NJ		EVA	0,07
PU 3540 RB		EVA	0,15
PU 3540 NJ		EVA	0,15

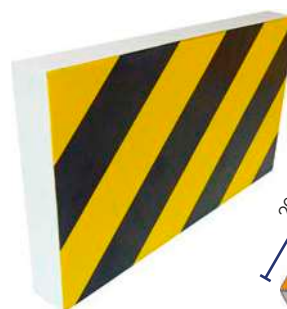
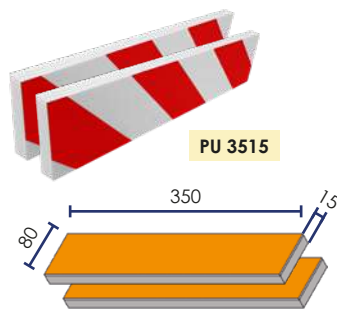

PU 3540

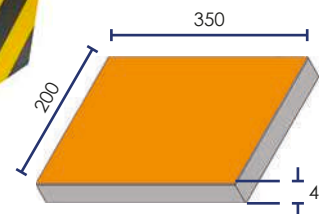

Code				
PU 5020 RB *		NBR	0,125	75 cm
PU 5020 NJ		NBR	0,125	
PU 5020 WH		NBR	0,125	
PUC 500 RB *		NBR	0,840	5 m
PUC 500 NJ		NBR	0,840	



PUC 500



PU 5020

\* Jusqu'à épuisement du stock ◦ While stock lasts ◦ Hasta agotar existencias ◦ Solange der Vorrat reicht



PU

# PROTECTIONS DROITES

WALL PROTECTOR ◦ PROTECCIÓN RECTA  
WANDSCHUTZ

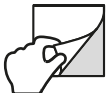

Code				
PU 102 RB		NBR	0,32	1 m
PU 102 NJ		NBR	0,32	
PU 352 RBG		NBR	1,6	5 m
PU 352 NJ		NBR	1,6	
PU 1502 RBG		NBR	1,35	1,5 m
PU 1502 NJ		NBR	1,35	

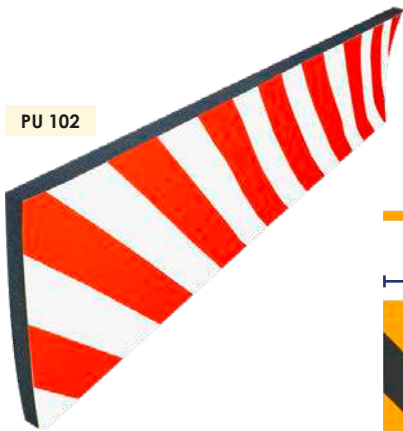

PU 102



PU 352

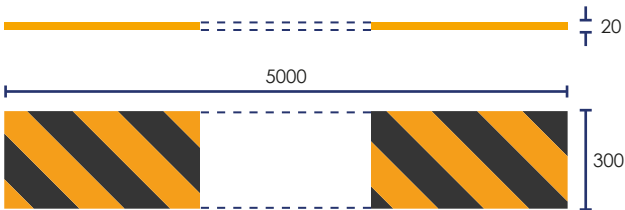

PU 1502

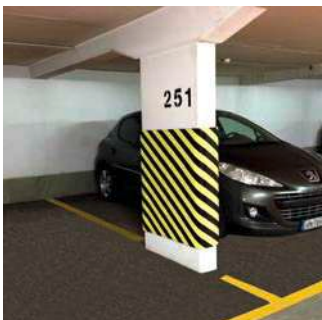



RQ 1000

**PROTECTIONS D'ANGLE** ◦ **CORNER PROTECTION**  
**PROTECTOR DE ESQUINAS** ◦ **RAMMSCHUTZECKE**



Code			
RQ 836		4 x 8 mm	1,30
RQ 800		6 x 10 mm	3,80
SQ 818		6 x 10 mm	4,40

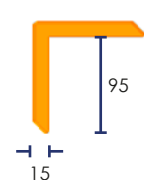
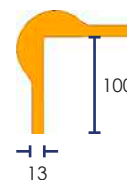
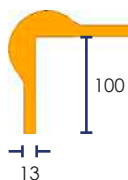
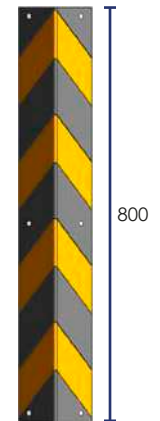
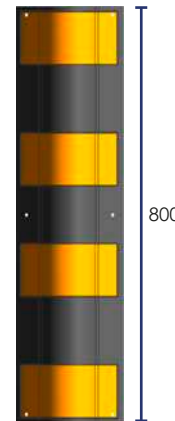
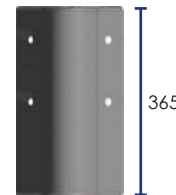

**PROTECTION DE MUR** ◦ **WALL PROTECTOR**  
**PROTECTOR DE PARED** ◦ **WANDRAMMSCHUTZ**



Code			
RQ 1000		3 x 12 mm	7,50

OPTION  
 OPTIONAL  
 OPCIÓN  
 OPTIONAL

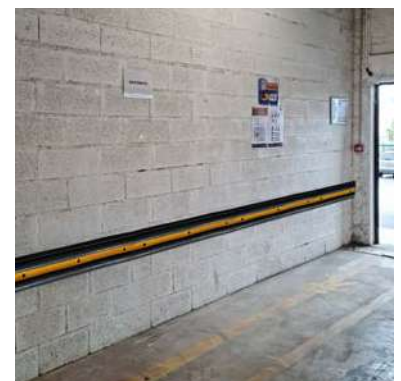
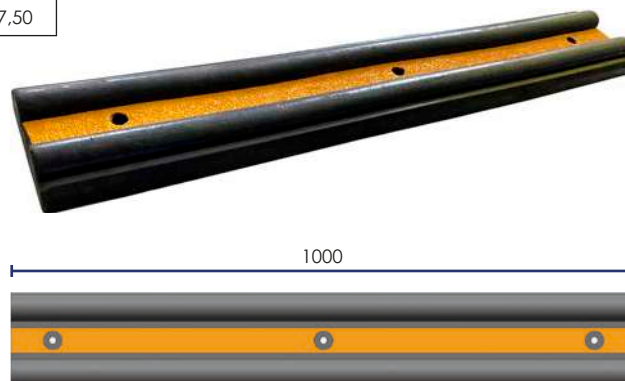



RQP 114

RTU 820

**PROTECTIONS D'ANGLE** ◦ CORNER PROTECTION  
**PROTECTOR DE ESQUINAS** ◦ RAMMSCHUTZECKE



CAOUTCHOUC  
 RUBBER  
 CAUCHO  
 KAUSCHUK

Code			
RQP 114 NJ		6 x 4 mm	1,70
RQR 114 NJ		6 x 4 mm	2,50



RQR 114 NJ



RQP 114 NJ



RQR 114 NJ

RQP 114 NJ



RQP 114 NJ



RQR 114 NJ

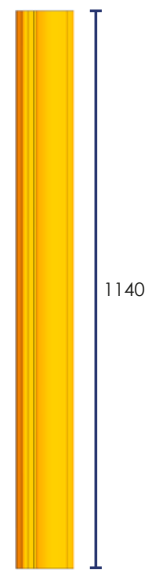

**PROTECTIONS DE CANALISATION** ◦ PIPE PROTECTOR  
**PROTECTOR DE TUBERÍA** ◦ SÄULENSCHUTZ



CAOUTCHOUC  
 RUBBER  
 CAUCHO  
 KAUSCHUK

Code			
RTU 815 NJ		8 x 6 mm	3,50
RTU 820 NJ		8 x 6 mm	5,00

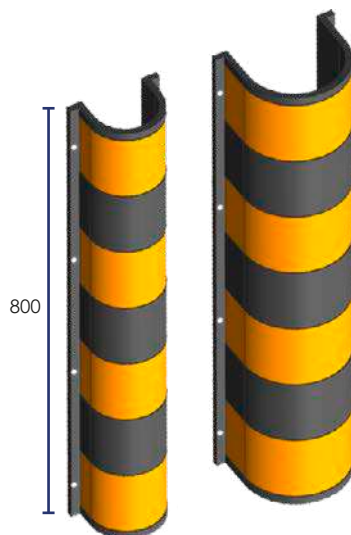

RTU 815 NJ

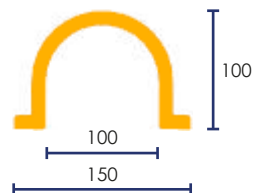

RTU 820 NJ

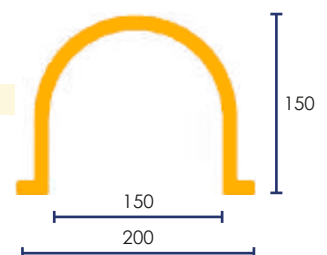





**BRA 1000**

**POD 81 ALU**

**EQUIPEMENTS DE QUAIS** ◦ DOCK EQUIPMENT  
**EQUIPAMIENTO PARA MUELLES DE CARGA** ◦ LADERAMPEN ZUBEHÖR

**PROJECTEUR DE QUAIS À LED**

DOCK LED LIGHT ◦ FOCO LED MUELLE DE CARGA ◦ LED SCHEINWERFER



- Projecteur de quai avec lampe led sur bras articulé en acier.
- Longueur déployé 1,25 m. Longueur fermé 85 cm.
- Câble inséré dans les tubes.
- Platine avec 4 fixations murales.
- Lampe led 50 W AC 85-265 V - IP 65.
- Luminosité 80 lm/w - 100 lm/w (valeurs d'efficacité lumineuse) 6500 K (Kelvins).

- Steel articulated arm with led light.
- Extended length 1.25m. Closed length 85 cm.
- Wires inserted in the tubes.
- Plate with 4 wall mountings.
- Led lamp 50 W AC 85-265V - IP 65.
- Brightness 80lm/w-100lm/w (light efficiency) 6500 K (Kelvins).

- Foco de muelle a led en brazo de acero articulado.
- Longitud extendida 1.25m. Longitud cerrada 85 cm.
- Cable insertado en los tubos.
- Placa con 4 fijaciones murales.
- Lámpara led 50 W AC 85-265V - IP 65.
- Luminosidad 80lm/w-100lm/w (valores de eficacia luminosa) 6500 K (Kelvins).

- Dock-Projektor mit LED-Lampe ans Stahlgelenkarm.
- Entfaltete Länge 1.25 m. Geschlossene Länge 85 cm.
- In die Rohre eingestztes Kabel.
- Platine mit 4 Wandhalterungen.
- AC 50W LED- Lampe 85-265 V - IP65.
- Helligkeit 80 lm/w - 100 lm/w (werte der Lichtausbeute) 6500 K (Kelvin).

**PROTECTION DE VOIRIE** ◦ GROUND PROTECTION ◦ PROTECCIONES DE SUELO ◦ ABSTÜTZPLATTEN

Code		
<b>POD 81 ALU</b>	820 x 610	2,2



**POD 81 ALU**

Code		
<b>POD 304 INOX *</b>	820 x 610	7,5
<b>POD 316 INOX *</b>		7,5



**POD - INOX**



\* Sur commande ◦ Under request ◦ bajo pedido ◦ Auf Bestellung



## PROTECTION DE QUAIS ◦ DOCKS BUMPERS PROTECTOR MUELLE DE CARGA ◦ LADERAMPENSCHUTZ



RB 300

RB 500



RB 500 TPU

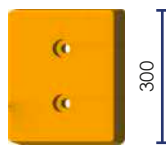

RB 300

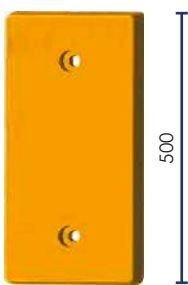

RB 500



Code		
RB 300	300 x 230 x 105	9,0
RB 500	500 x 250 x 100	16,0
BRB 300	320 x 270 x 10	7,5
BRB 500	500 x 250 x 10	10,0



BRB 300

BRB 500

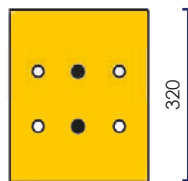

BRB 300

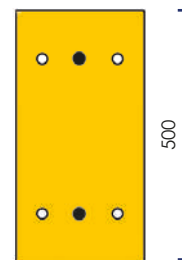

BRB 500

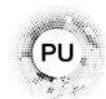

Code		
RB 500 TPU	500 x 250 x 100	5,0
BRB 502	520 x 275 x 10	16,0

Blocage 4 côtés.  
4 sides stops.  
Bloqueo con 4 esquinas.  
4 Seiten Stopp.



BRB 502

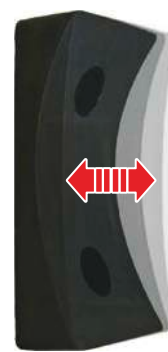

RB 500 TPU

Heurtoir en polyuréthane. Se déforme et revient ensuite à sa position.  
Bumper made of polyurethane. Absorbs shocks and returns to its original position.

Protección de muelle en poliuretano. Absorbe los golpes y vuelve a su posición inicial.

Dock-Schutzladerampe aus Polyurethan, stoßdämpfend.

## PANNEAU SOLAIRE A LED SOLAR LED TRAFFIC SIGN PANEL DE TRAFICO CON LED LEUCHTTAFELN

PNX-5070-CHARIOT

550 x 700 mm



Informations techniques, voir page 35  
Technical specifications see page 35  
Datos técnicos ver página 35  
Technische Informationen, siehe Seite 35





Créa Luxe.fr



**RQDB**

**PROTECTION HAUTE RÉSISTANCE**  
**HEAVY DUTY BUMPERS** ◦ **PROTECCIÓN ALTA RESISTENCIA**  
**RAMMSCHUTZ MIT HOHEM WIDERSTAND**



CAOUTCHOUC VULCANISÉ  
 VULCANIZED RUBBER  
 CAUCHO VULCANIZADO  
 VULKANISIERTEM KAUSCHUK

Code			
RQDB 100	●	3	8,45
RQDB 150	●	2	14,00
RQDB 200	●	3	32,00



 <p><b>RQDB 100</b></p>		
 <p><b>RQDB 150</b></p>		
 <p><b>RQDB 200</b></p>		



## Balisage ◦ Safety marking









**PLASTIQUE** ◦ PLASTIC ◦ PLÁSTICO ◦ KUNSTSTOFF

**POTEAUX ET BASES** ◦ POSTS AND BASES ◦ POSTES Y BASES ◦ PFOSTEN UND BASEN

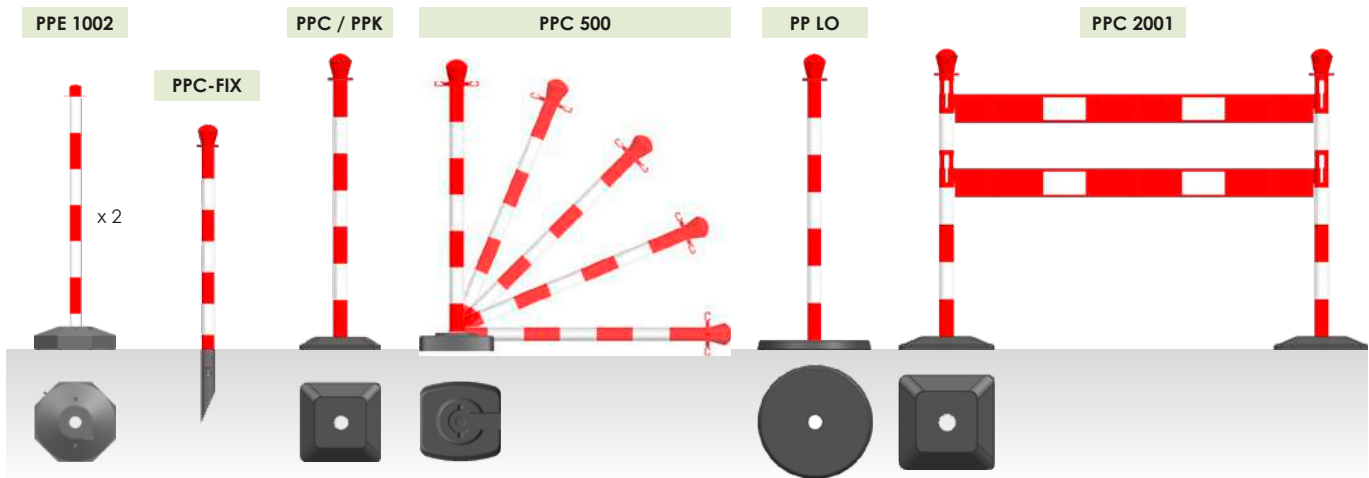

**ACCESSOIRES** ◦ ACCESSORIES ◦ ACCESORIOS ◦ ZUBEHÖR

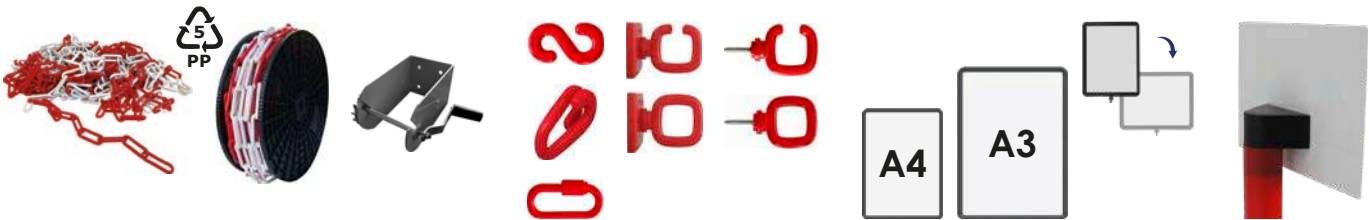

**BALISE HAUTE VISIBILITÉ** ◦ HIGH VISIBILITY BOLLARD  
BALIZA ALTA VISIBILIDAD ◦ PFOSTEN MIT HOHER SICHTBARKEIT

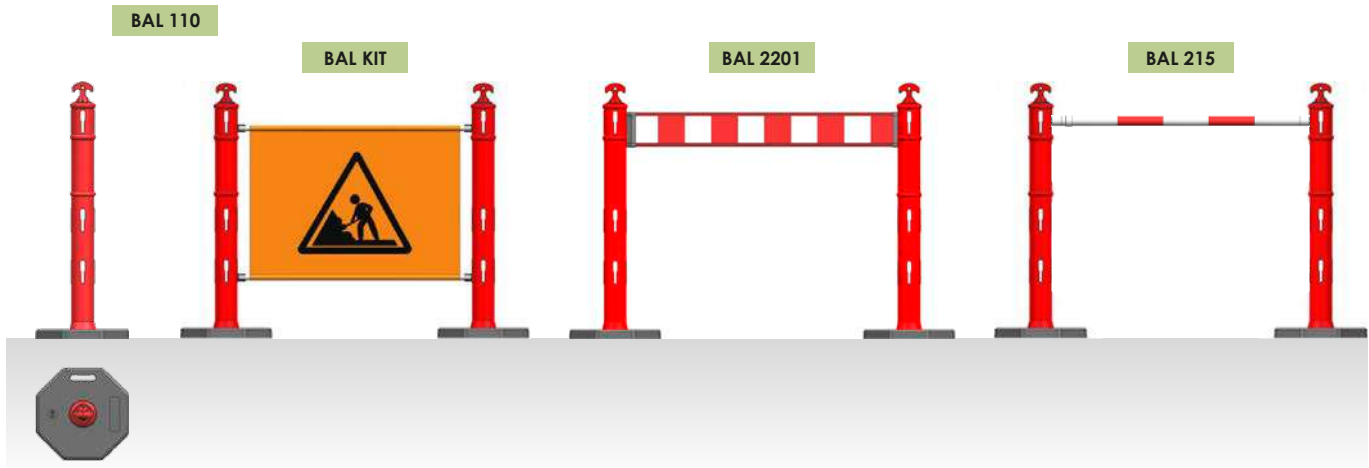





# POTEAU DE BALISAGE PREMIUM

SIGN POST ◦ POSTE DE BALIZAMIENTO  
KETTENSTÄNDER KUNSTSTOFF

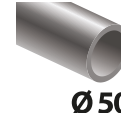

Code	
PPC 40 RB	
PPC 40 NJ	
PPC 40 BU	
PPC 40 VE	
PPK 40 RB	
PPK 40 NJ	
PPK 40 BU	
PPK 40 VE	

5,0

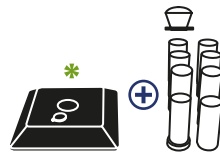

1,0

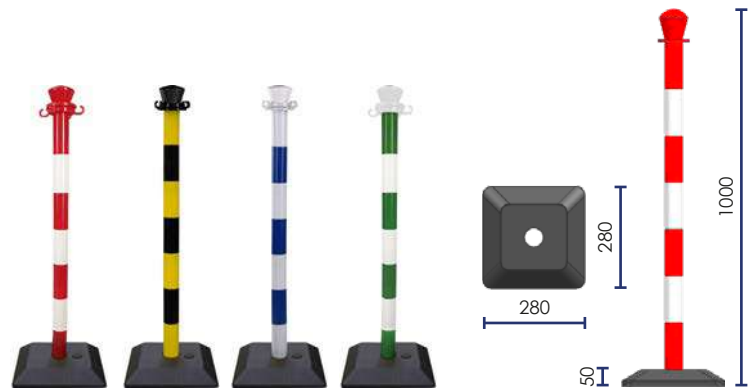

Code	
PPC 1001 RB	
PPC 1001 NJ	
PPC 1001 B	
PPC 1001 G	
PPC 1001 N	
PPC 3001 RB	
PPC 3001 NJ	
PPC 3001 B	
PPC 3001 G	
PPC 3001 N	

5,2

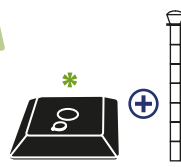

1,2

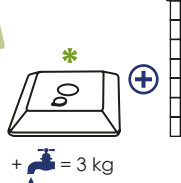

\* Base lestée ◦ Loaded base ◦ Base lastrada ◦ Beschwertem Standfuß

Base vide ◦ Empty base ◦ Base vacía ◦ Leerer Standfuß + 3 kg

OPTION\* ◦ OPTIONAL ◦ OPCIÓN ◦ OPTIONAL \* ▶ p. 175



# KIT POTEAUX CHAINE

POST & CHAIN KIT ◦ KIT DE POSTES CON CADENA  
KETTENSTÄNDER SATZ

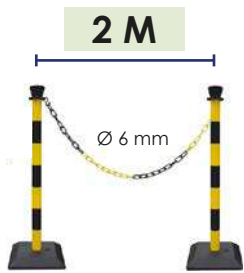
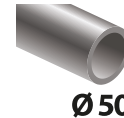

Code
CBR SET RB
CBR SET NJ
CBR SET BB
CBR SET NN
CBR SET GB
PPC 3002 RB
PPC 3002 NJ
PPC 3002 BB
PPC 3002 NN
PPC 3002 GB

10,6

Code
PPC SET 40 RB
PPC SET 40 NJ
PPC SET 40 VB
PPC SET 40 BB
PPK SET 40 RB
PPK SET 40 NJ
PPK SET 40 VB
PPK SET 40 BB

10,2

2,6

2,2

+ = 3 kg

+ = 3 kg

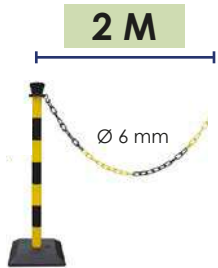

Code
CBR EXT RB
CBR EXT NJ
CBR EXT BB
CBR EXT NN
CBR EXT GB
PPC 3 EXT RB
PPC 3 EXT NJ
PPC 3 EXT BB
PPC 3 EXT NN
PPC 3 EXT GB

5,4

Code
PPC EXT RB
PPC EXT 40 NJ
PPC EXT 40 VB
PPC EXT 40 BB
PPK EXT RB
PPK EXT NJ
PPK EXT 40 VB
PPK EXT 40 BB

5,2

1,4

1,2

+ = 3 kg

+ = 3 kg

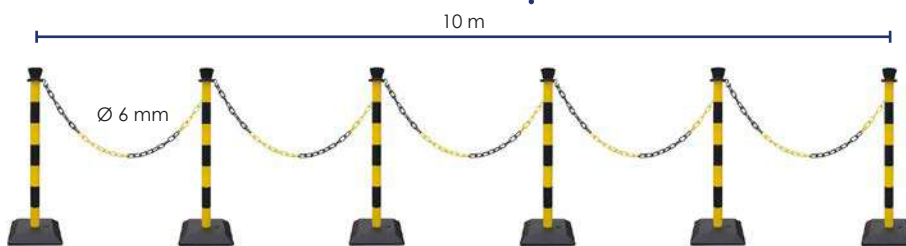

Code
CBR 6 SET
CBR 6 SET NJ
CBR 6 SET BB
CBR 6 SET NN
CBR 6 SET GB
PPC 3006 RB
PPC 3006 NJ
PPC 3006 BB
PPC 3006 NN
PPC 3006 GB

31,7

Code
PPC SET 406 RB
PPC SET 406 NJ
PPC SET 406 VB
PPC SET 406 BB
PPK SET 406 RB
PPK SET 406 NJ
PPK SET 406 VB
PPK SET 406 BB

30,5

7,7

6,5

+ = 3 kg

+ = 3 kg

\* Base lestée ◦ Loaded base  
Base lastrada ◦ Beschwerter Standfuß

Base vide ◦ Empty base ◦ Base vacía ◦ Leerer Standfuß + = 3 kg

\*\* Chaine blanche ◦ White chain ◦ Cadena blanca ◦ Kettenfarbe weiß





# PPC-FIX

## POTEAU DE BALISAGE ◦ SIGNPOST POSTE DE BALIZAMIENTO ◦ KETTENSTÄNDER



### À PLANTER ◦ WITH STAKE ◦ CON ESTACA ◦ VERSION : BODENBEFESTIGUNG

Code	
PPC-FIX RB	
PPC-FIX VB *	
PPC-FIX BB *	
PPC-FIX NJ	
PPC-FIX B	
PPC-FIX G	
PPC-FIX N	

1,0

Ø 54  
Ø 50

950

300

+

+

+

### BASE LOURDE ◦ HEAVY BASE ◦ BASE PESADA ◦ VERSION : STANDFUSS

PPLO 100 RB		10,6									990
PPLO 100 NJ											
PPLO 100 B											
PPLO 100 G											
PPLO 100 N											
PPVD 100 RB		1,2								400	
PPVD 100 NJ											
PPVD 100 B											
PPVD 100 G											
PPVD 100 N											

+ = 4 kg

Base lestée ◦ Loaded base  
Base lastrada ◦ Beschwerstem Standfuß

Base vide ◦ Empty base ◦ Base vacía ◦ Leerer Standfuß + = 4 kg

OPTION\* ◦ OPTIONAL ◦ OPCIÓN ◦ OPTIONAL \* ▶ p. 175





PPC 2001

**POTEAU DE BALISAGE PLIANT**  
**FOLDABLE SIGNPOST** ◦ **POSTE DE BALIZAMIENTO PLEGABLE**  
**VERSION : ZUSAMMENLEGBAR**

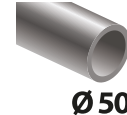

Code	
PPC 500 LOVB *	
PPC 500 LOBB *	
PPC 500 LOG	
PPC 500 LOB	
PPC 500 LONJ	
PPC 500 LON	
PPC 500 LORB	
PPC 500 VB *	
PPC 500 BB *	
PPC 500 G	
PPC 500 B	
PPC 500 NJ	
PPC 500 N	
PPC 500 RB	

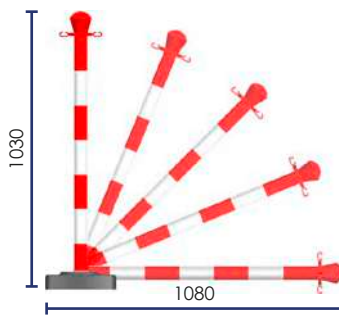

+ = 2,6 kg

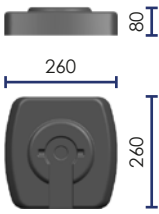
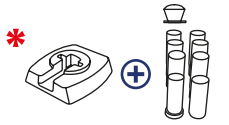

\* Base lestée ◦ Loaded base  
 Base lastrada ◦ Beschwertem Standfuß Base vide ◦ Empty base ◦ Base vacía ◦ Leerer Standfuß + = 2,6 kg

**BARRICADE** ◦ **BARRIERS** ◦ **BARRERAS** ◦ **ABSPERRUNG**

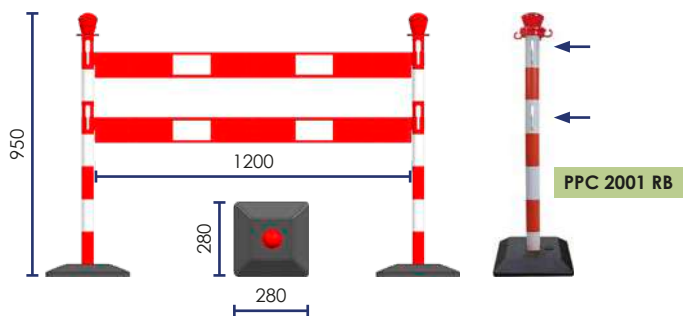
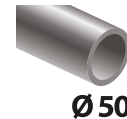
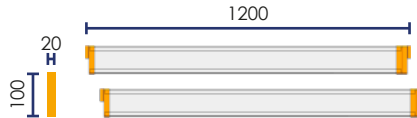





PPE



PPC A3 / A4

**POTEAU D'INFORMATION** ◦ INFORMATION POST  
**POSTE DE INFORMACIÓN** ◦ INFO-STÄNDER KUNSTSTOFF

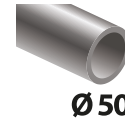

Code	
PPC A4 RB	
PPC A4 NJ	
PPC A4 B	
PPC A4 G	
PPC A4 N	
PPC A4 BB *	
PPC A4 VB *	

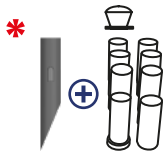
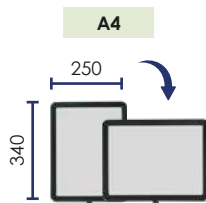

Base lestée  
 Loaded base  
 Base pesada  
 Beschwertem standfuß

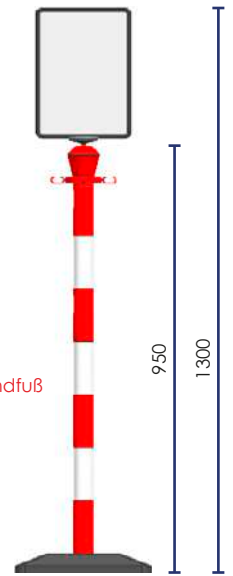
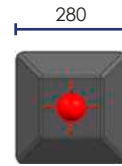

**POTEAU PLASTIQUE BUDGET**  
**BUDGET PLASTIC POST** ◦ **POSTE PLÁSTICO**  
**KETTENSTÄNDER KUNSTSTOFF**

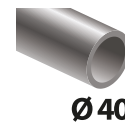

Code					kg
PPE 1002 RB		2	-	-	1,2
PPE 2100 RB		2	2 m	2	1,6
PPE 6100 RB		6	10 m	10	6,2

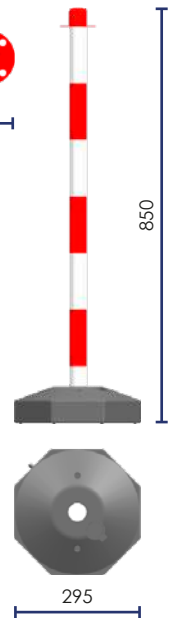
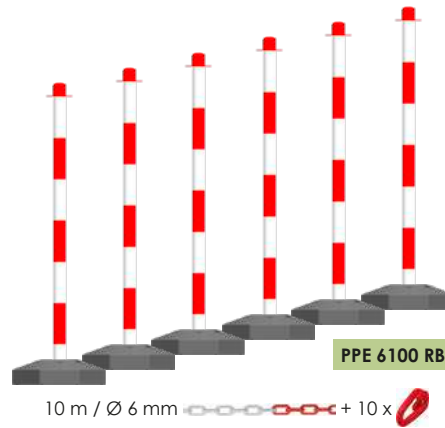
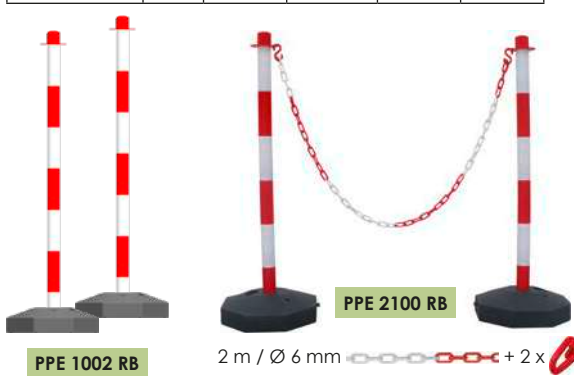
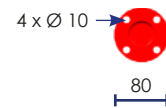



## ACCESSOIRES ◦ ACCESSORIES ◦ ACCESORIOS ◦ ZUBEHÖR



C FLUO 825 SBS



DVD 350

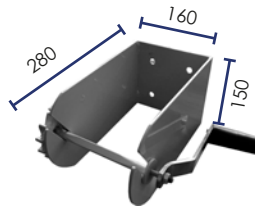

CMLRB 806 NB \*\*



Avec blocage  
Livré sans fixation  
With stop  
No fixation included  
Con bloqueo  
No incluye fijaciones  
Mit Blockierung  
Ohne Fixierung

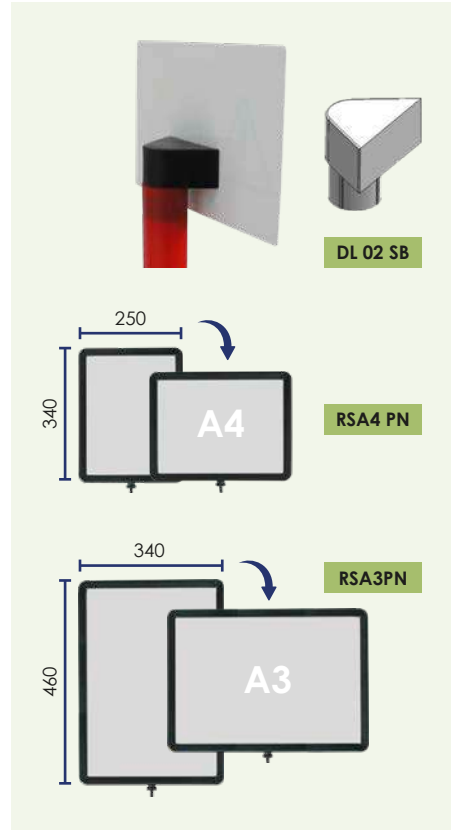

Code		∅	↔
CBR 625 NP		6	2
CBR 610 FAB			10
CBR 601 SBS			25
CNJ 625 FAB			2
CNJ 610 FAB			10
CNJ 601 SBS			25
CFLUO 825 SBS		8	25
CPB 820 NP			2
CPB 801 SBS			25
CPJ 801 SBS *			25
CNJ 820 NP			2
CNJ 801 SBS			25
CPN 820 FAB			2
CPN 801 SBS			25
CBR 820 NP			2
CBR 805 SB			5
CBR 810 SB		10	
CBR 801 SBS		25	
CMLRB 806 NB **		25	
CMLRB 825 SBS		25	
CPR 801 SBS *		25	
CBV 820 SB		2	
CBV 801 SBS		25	
CBB 820 SB		2	
CBB 801 SBS		25	
CBR 101 SBS		10	25
CNJ 101 SBS			25

Code		∅	
MRP 602 NP		6	1 ● + 1 ○
MRR 604 SB			x 4
MRN 604 SB			x 4
MRB 604 SB			x 4
MRP 802 NP		8	1 ● + 1 ○
MRB 804 SB			x 4
MRN 804 SB			x 4
MRR 804 SB			x 4
MRB 1004 SBS		10	x 4
MRN 1004 SBS			x 4
MRR 1004 SBS			x 4
APR 804 SB			x 4
APN 804 SB		8	x 4
APB 804 SB			x 4
EPR 804 SB			x 4
EPN 804 SB			x 4
EPB 804 SB		8	x 4
ERB 804 SB			2 ● + 2 ○

Code		∅	
CRO 004 SB		8	x 4
CNO 004 SB			
CBO 004 SB			
CRF 004 SB			
CNF 004 SB			
CBF 004 SB			
APF 801 R SB		10	x 1
APF 801 N SB			
APF 801 B SB			
APO 801 R SB			
APO 801 N SB			
APO 801 B SB			

\* Jusqu'à épuisement du stock ◦ While stock lasts ◦ Hasta agotar existencias ◦ Solange der Vorrat reicht





BAL 110

**BALISE HAUTE VISIBILITÉ** ○ HIGH VISIBILITY BOLLARD  
**BALIZA ALTA VISIBILIDAD** ○ PFOSTEN MIT HOHER SICHTBARKEIT



CAOUTCHOUC VULCANISÉ  
 VULCANIZED RUBBER  
 CAUCHO VULCANIZADO  
 VULKANISIERTEM KAUTSCHUK

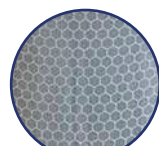
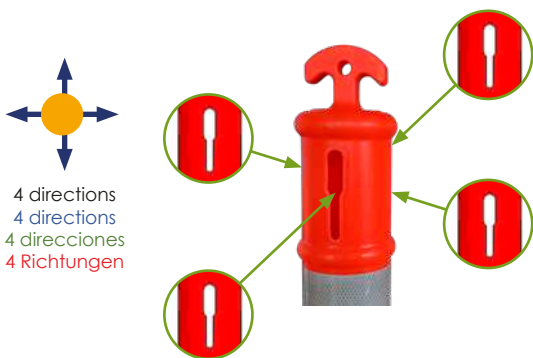
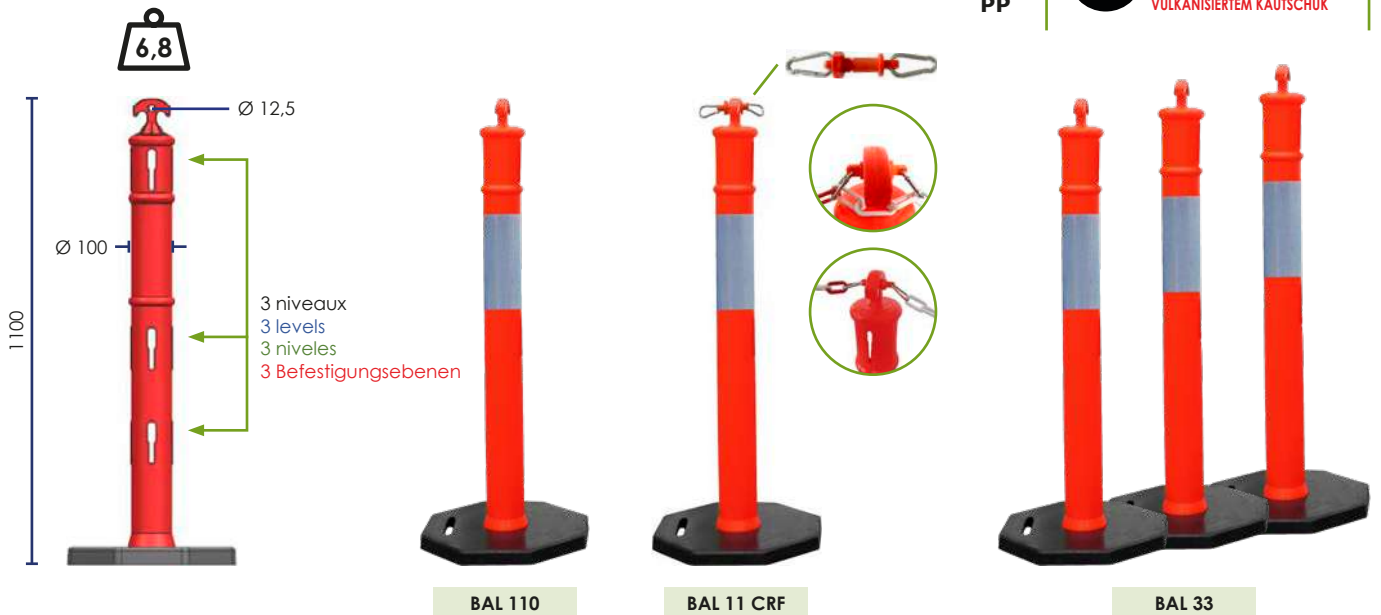

Classe 1 ○ Class 1  
 Clase 1 ○ Klasse 1



Poignée  
 Handle  
 Asa  
 Handgriff



OPTION ○ OPTIONAL ○ OPCIÓN ○ OPTIONAL



RSNA 580 RB  
 80 mm x 500 m



RSNA 01 RB  
 50 mm x 100 m





**KIT CHAINE** ○ CHAIN KIT  
**KIT CON CADENA** ○ SET PFOSTEN MIT KETTEN



CAOUTCHOUC VULCANISÉ  
 VULCANIZED RUBBER  
 CAUCHO VULCANIZADO  
 VULKANISIERTEM KAUSCHUK

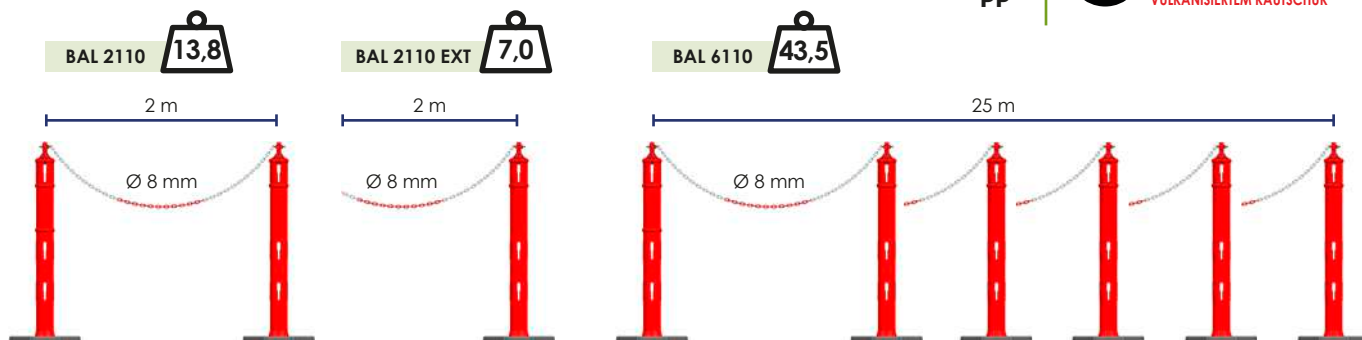

OPTION ○ OPTIONAL ○ OPCIÓN ○ OPTIONAL



- 25 m / Ø 6 mm CBR 601 SBS
- 25 m / Ø 8 mm CBR 801 SBS
- 25 m / Ø 10 mm CBR 101 SBS

CRF 210 SB



**KIT BARRE EXTENSIBLE** ○ EXPANDABLE BARRIER KIT  
**KIT BARRERA EXTENSIBLE**  
**SET ABSPERRPFOSTEN MIT ABSPERRSTANGEN**



CAOUTCHOUC VULCANISÉ  
 VULCANIZED RUBBER  
 CAUCHO VULCANIZADO  
 VULKANISIERTEM KAUSCHUK

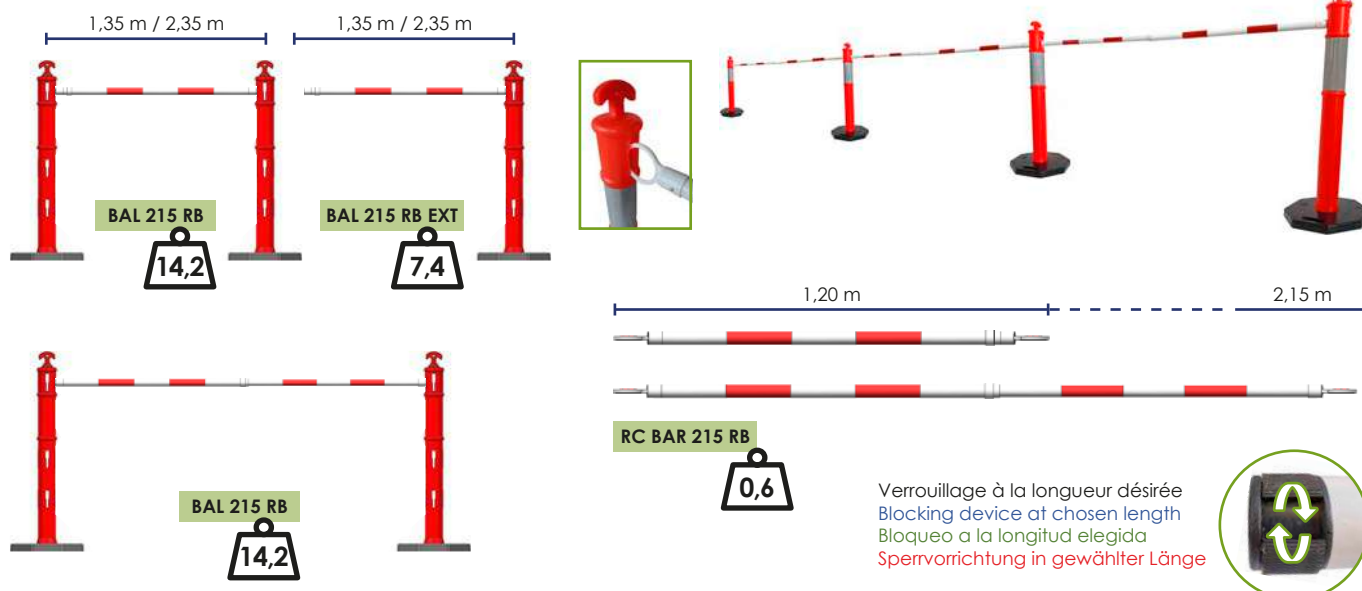

Verrouillage à la longueur désirée  
 Blocking device at chosen length  
 Bloqueo a la longitud elegida  
 Sperrvorrichtung in gewählter Länge







Créa Luxe.fr

**KIT BARRIÈRE EXTENSIBLE** ○ **EXPANDABLE BARRIER KIT**  
**KIT CON BARRERAS EXTENSIBLES** ○ **SET ABSPERRPFOSTEN MIT LATTEN**



CAOUTCHOUC VULCANISÉ  
 VULCANIZED RUBBER  
 CAUCHO VULCANIZADO  
 VULKANISIERTEM KAUSCHUK

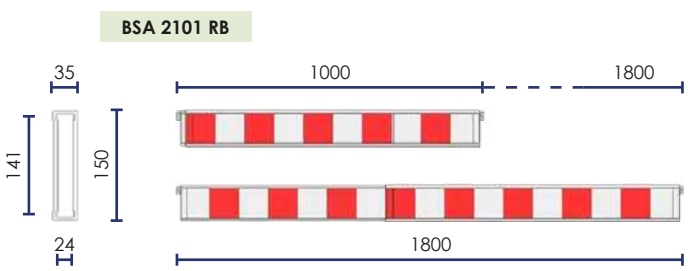
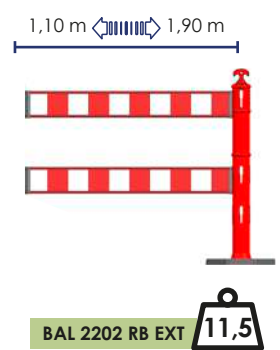
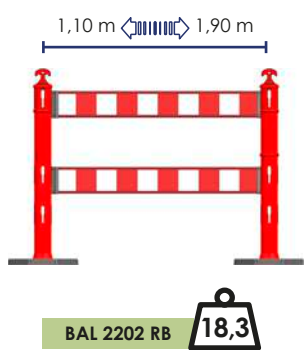
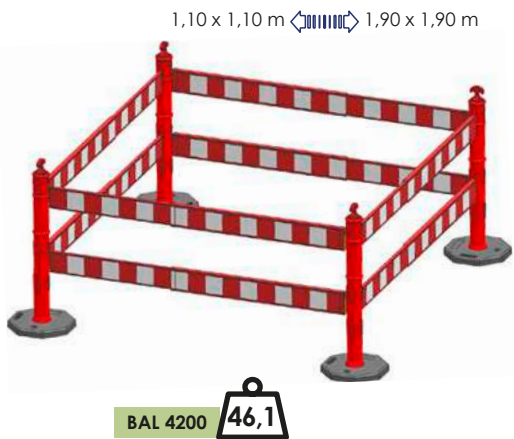
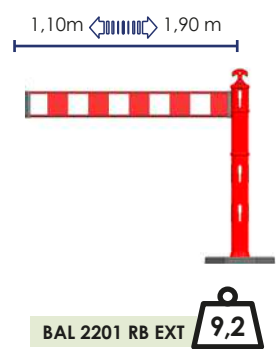
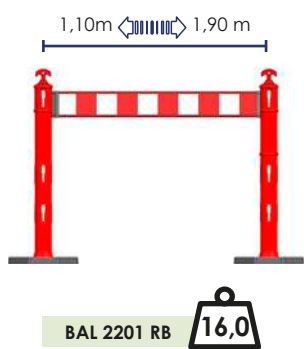





## KIT BÂCHE ◦ TARPAULIN KIT

### KIT CON LONA ◦ SET ABSPERPFOSTEN MIT PLANE



CAOUTCHOUC VULCANISÉ  
VULCANIZED RUBBER  
CAUCHO VULCANIZADO  
VULKANISIERTEM KAUSCHUK



Toile PP enduit PVC  
PVC coated polypropylene fabric  
Lona de PP recubierta de PVC  
PVC beschichtete Polyestergerewebe

Imprimé 1 face  
1 side printed  
Impreso a 1 cara  
1 seite ist bedruckt

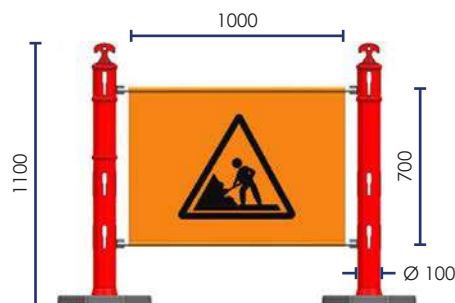

## BÂCHE PERSONNALISÉE ◦ CUSTOMIZED TARPAULIN

### LONA PERSONALIZADA ◦ KUNDENSPEZIFISCHE PLANEN

Minimum 5 barrières ◦ Minimum order 5 barriers  
Pedido mínimo: 5 barreras  
Mini Bestellungen 5 Absperrungen



Toile PP enduit PVC  
PVC coated polypropylene fabric  
Lona de PP recubierta de PVC  
PVC beschichtete Polyestergerewebe

Choix de couleur de fond, impression 4 couleurs  
Background to customer choice, 4 colors print  
Elección del color del fondo, impresión a 4 colores  
Wahl der Hintergrundfarbe, 4-farbiger Druck

## BÂCHE BRISE VENT ◦ WIND BREAK TARPAULIN

### LONA CORTAVIENTOS ◦ WINDFESTE PLANE

Minimum 5 barrières ◦ Minimum order 5 barriers  
Pedido mínimo: 5 barreras  
Mini Bestellungen 5 Absperrungen



Bâche brise vent microperforée  
Microperforation wind break tarpaulin  
Lona cortavientos microperforada  
Mikroperforierte Windschutzhülle

Choix de couleur de fond, impression 4 couleurs  
Background to customer choice, 4 colors print  
Elección del color del fondo, impresión a 4 colores  
Wahl der Hintergrundfarbe, 4-farbiger Druck







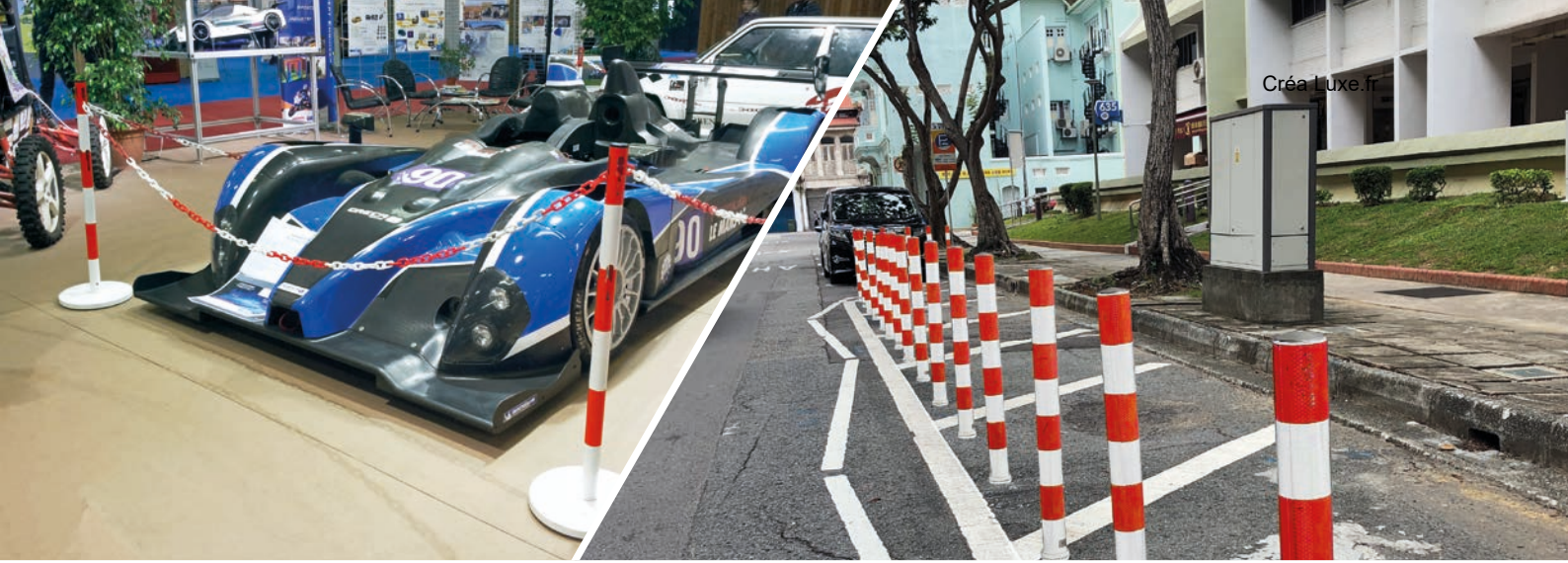

**ACIER** ◦ **STEEL** ◦ **ACERO** ◦ **STAHL**



**POTEAUX ET BASES** ◦ **POSTS AND BASES** ◦ **POSTES Y BASES** ◦ **PPOSTEN UND BASEN**

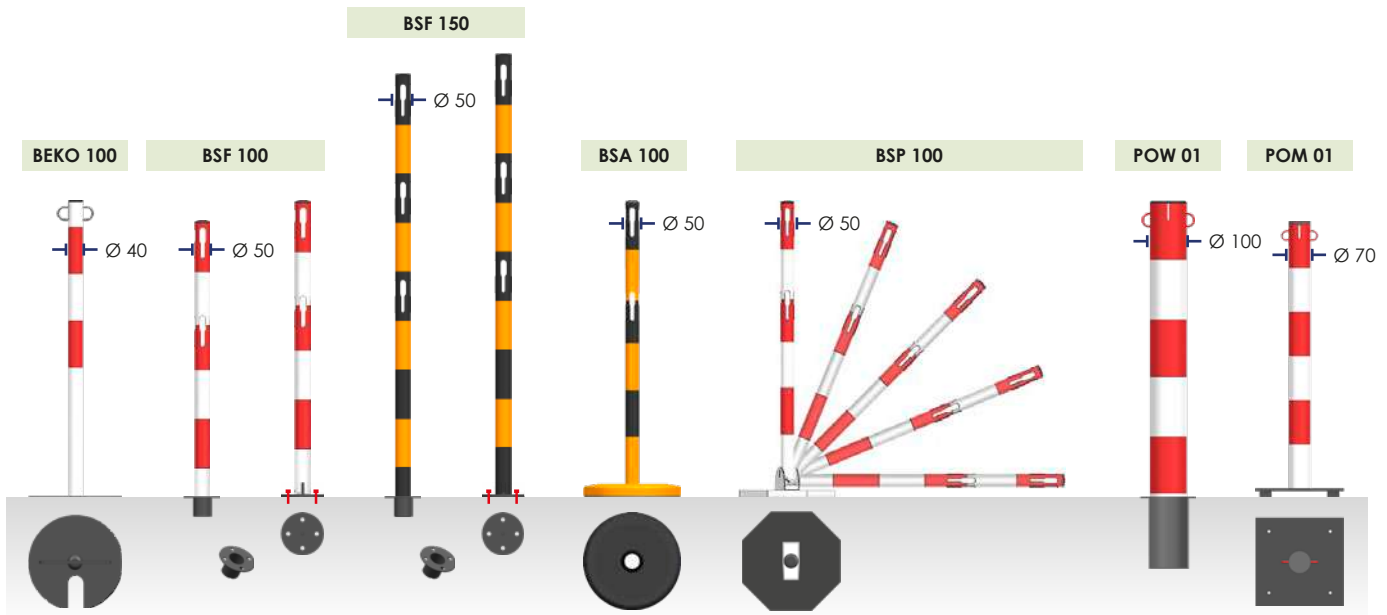

**KITS**

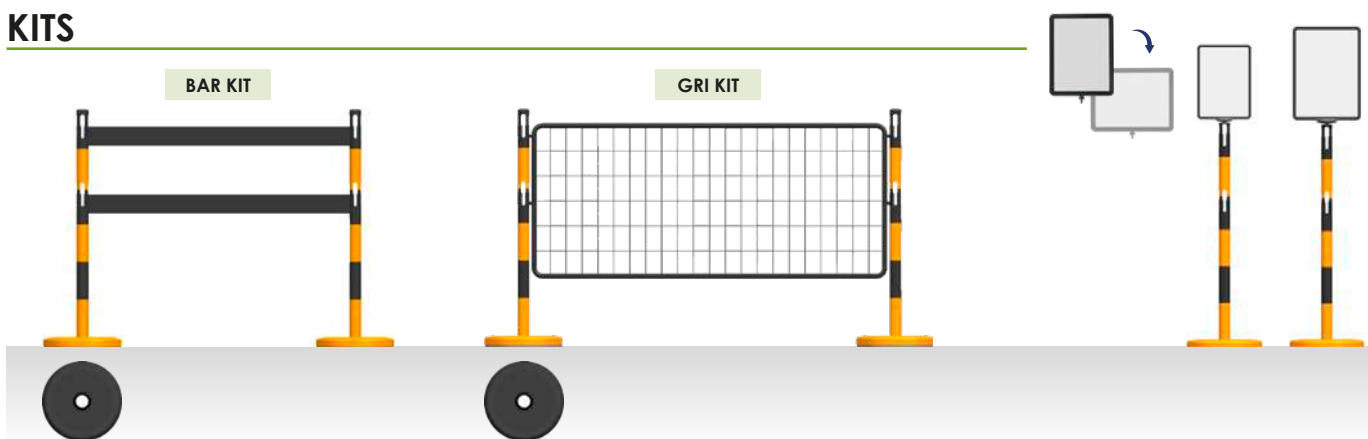

**ACCESSOIRES** ◦ **ACCESSORIES** ◦ **ACCESORIOS** ◦ **ZUBEHÖR**







**BSA**

**POTEAU ACIER BASE LESTÉE**  
**STEEL POST WITH LOADED BASE** ◦ **POSTE DE ACERO CON BASE PESADA**  
**KETTENSTÄNDER AUS STAHL MIT SCHWERE BASISPLATTE**

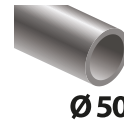

Code	
BSA 100 AISI *	
BSA 100 B	
BSA 100 N	
BSA 100 RB	
BSA 100 NJ	

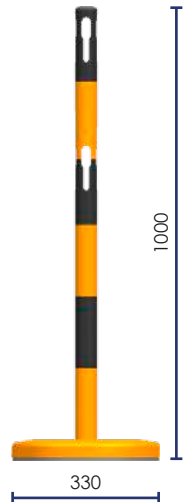

BSA 100



2 niveaux  
 2 levels  
 2 niveles  
 2 Aufhängenhöhen



4 directions  
 4 directions  
 4 direcciones  
 4 Anschlüsse

INCLUS ◦ INCLUDED ◦ INCLUIDO ◦ INKLUSIVE



OPTION ◦ OPTIONAL ◦ OPCIÓN ◦ OPTIONAL

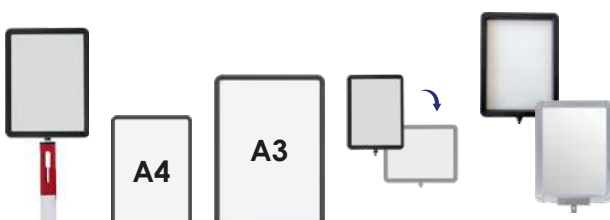

Code		
RS A4 PN		ABS
RS A3 PN		
RS A4		alu
RS A3		





**BSP 100**



**BSF**

**POTEAU DE BALISAGE**  
SIGN POST ◦ POSTE DE BALIZAMIENTO  
KETTENSTÄNDER



4 directions  
4 direcciones  
4 Richtungen

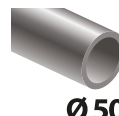

BSF 100 AISI

**À FIXER** ◦ TO FIX ◦ FIJOS ◦ ZU BEFESTIGENDEN

Code	
BSF 100 AISI *	
BSF 100 B	
BSF 100 N	
BSF 100 RB	
BSF 100 NJ	

2,4

BSF 100



BSF 150

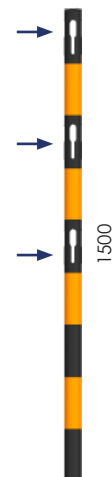
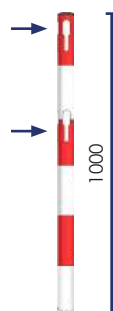

Code	
BSF 150 RB	
BSF 150 NJ	

3,5

**REPLIABLE** ◦ FOLDABLE ◦ PLEGABLE ◦ ZUSAMMENLEGBAR

Code	
BSP 100 B	
BSP 100 RB	
BSP 100 NJ	

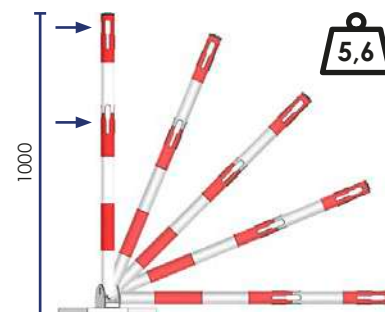
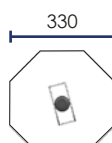

5,6

OPTION ◦ OPTIONAL ◦ OPCIÓN ◦ OPTIONAL ▶ BSF 100 / 150

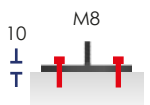
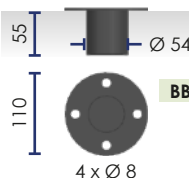

BBASE 200 AISI



INCLUS ◦ INCLUDED ◦ INCLUIDO ◦ INKLUSIVE



x 2 ▶ BSF / BSP 100  
x 3 ▶ BSF 150





POT 6 KIT



POT 1 KIT

## KIT CHAÎNE ACIER

### STEEL CHAIN KIT

### KIT CADENA METALICA ○ SET KETTEN STAHL



4 directions  
4 direcciones  
4 Richtungen

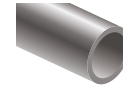

Ø50



POT - AISI -

Code	
POT 1 B KIT	○
POT 1 N KIT	●
POT 1 R KIT	◐
POT 1 J KIT	◑
POT 1 AISI KIT *	●

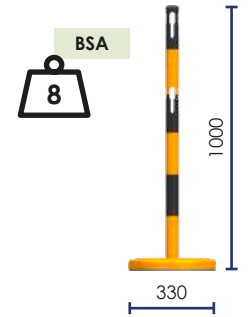

Code	
POT 6 B KIT	○
POT 6 N KIT	●
POT 6 R KIT	◐
POT 6 NJ KIT	◑
POT 6 AISI KIT *	●

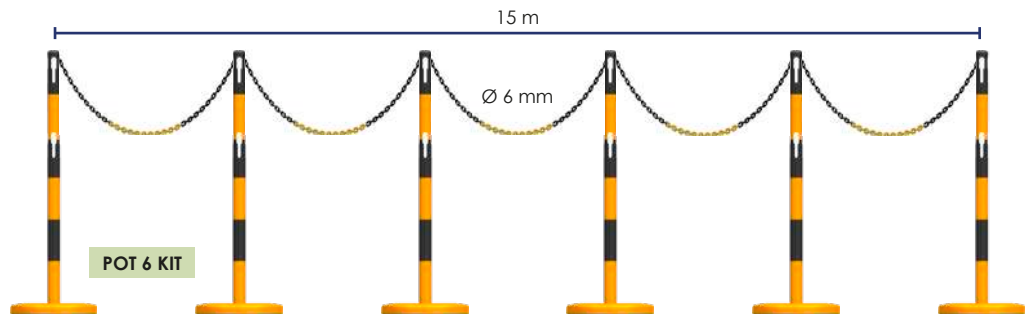

Code	
POT 1 B EXT	○
POT 1 N EXT	●
POT 1 R EXT	◐
POT 1 J EXT	◑
POT 1 AISI EXT *	●

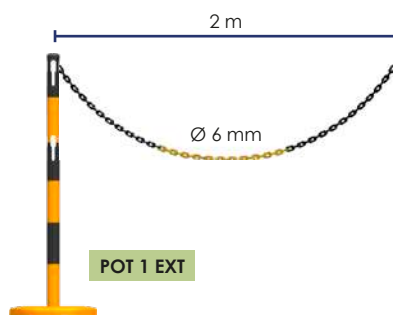

INCLUS ○ INCLUDED ○ INCLUIDO ○ INKLUSIVE



OPTION  
OPTIONAL  
OPCIÓN  
OPTIONAL

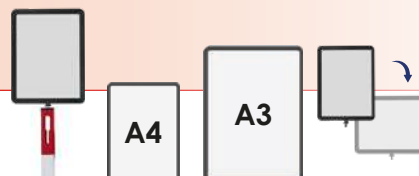

Code	
RS A4 PN	●
RS A3 PN	●
RS A4	○
RS A3	○



\* Poteaux et chaîne inox ○ Stainless steel posts and chain ○ Postes y cadena en acero inoxidable ○ Pfosten und Kette aus Edelstahl



# GRI KIT

## KIT GRILLE POSE LIBRE

FENCE KIT

KIT CON REJA ◦ SET ABSPERRUNG MIT GITTER

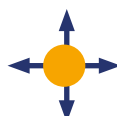

4 directions  
4 directions  
4 direcciones  
4 Richtungen

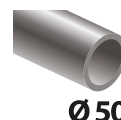

Code	
GRI CH KIT *	
GRI BK KIT	
GRI RB KIT	
GRI NJ KIT	

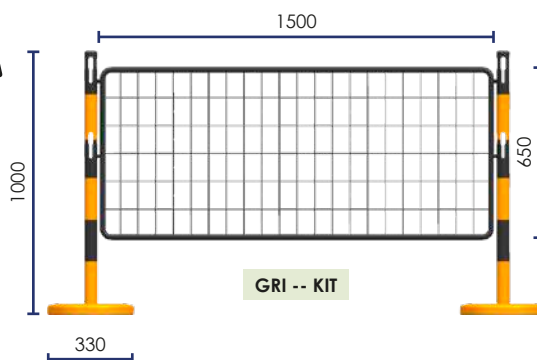

Code	
GRI CH EXT *	
GRI BK EXT	
GRI RB EXT	
GRI NJ EXT	

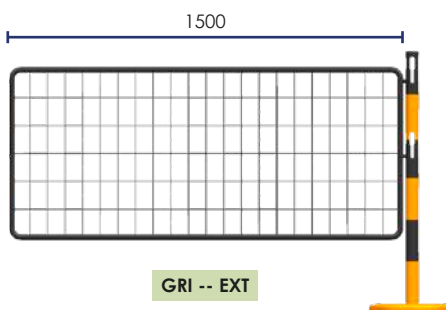

Code	
B 1500 ZG *	ZINGUÉ ZINC ZINCADO VERZINKTE
B 1500 N	
B 1500 R	

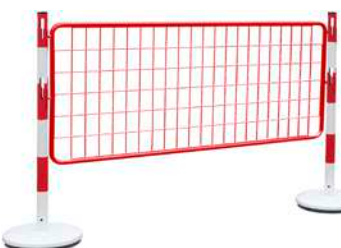
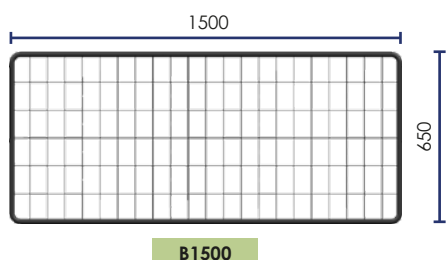

OPTION ◦ OPTIONAL ◦ OPCIÓN ◦ OPTIONAL

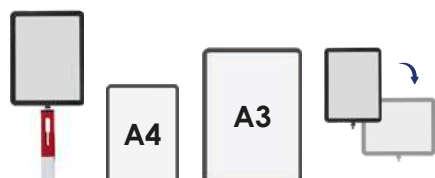

Code	
RS A4 PN	
RS A3 PN	
RS A4	
RS A3	

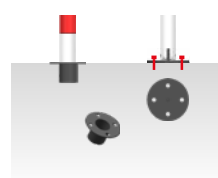

Fixation dans le sol ► p. 183  
Ground fixing ► p. 183  
Fijación al suelo ► p. 183  
Fixierung im Boden ► p. 183

\* Poteaux inox - Barrière acier zingué ◦ Stainless steel posts - zinc plated fence  
Postes de acero inoxidable - valla galvanizada ◦ Pfosten aus Edelstahl - Schranke aus verzinktem Stahl





# BAR- KIT

## KIT BARRIÈRE POSE LIBRE ◦ BARRIERS KIT KIT CON BARRERAS ◦ SET ABSPERRUNG MIT LATTEN



4 directions  
4 directions  
4 direcciones  
4 Richtungen

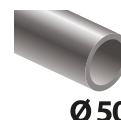

Code	
BAR-CH KIT *	
BAR-BK KIT	
BAR-RB KIT	
BAR-NJ KIT	

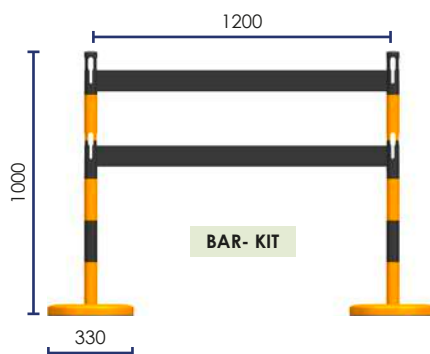

BAR- KIT



Code	
BAR-CH EXT *	
BAR-BK EXT	
BAR-RB EXT	
BAR-NJ EXT	

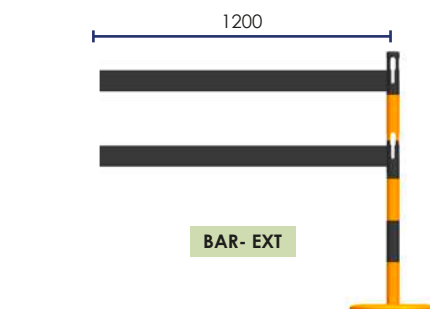

BAR- EXT



Code	
BSA 1202 ZG *	ZINGUÉ ZINC ZINCADO VERZINKTE
BSA 1202 N	alu
BSA 1202 RB	5 PP

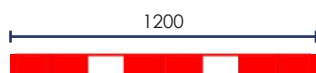
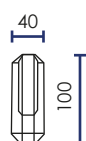

BSA 1202 RB



Code	
BSA 2101 RB	5 PP

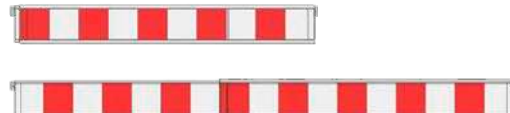
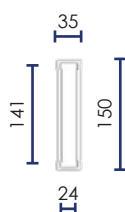

BSA 2101 RB



### OPTION ◦ OPTIONAL ◦ OPCIÓN ◦ OPTIONAL

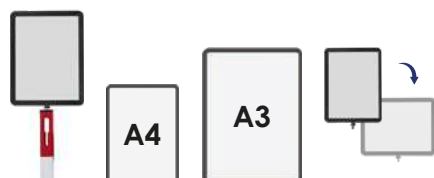

Code	
RS A4 PN	
RS A3 PN	
RS A4	alu
RS A3	alu

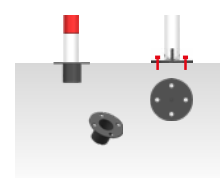

Fixation dans le sol ▶ p. 183  
Ground fixing ▶ p. 183  
Fijación al suelo ▶ p. 183  
Fixierung im Boden ▶ p. 183

\* Poteaux inox - Barrière acier zingué ◦ Stainless steel posts - zinc plated barriers  
Postes de acero inoxidable - barreras galvanizadas ◦ Pfosten aus Edelstahl - Schranke aus verzinktem Stahl



BEKO

**POTEAU EMPILABLE ACIER** ◦ **STACKABLE STEEL POST**  
**POSTE ACERO APILABLE** ◦ **KETTENSTÄNDER AUS STAHL**

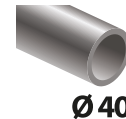

Code	
BEKO 100 BK	
BEKO 100 RB	
BEKO 100 NJ	

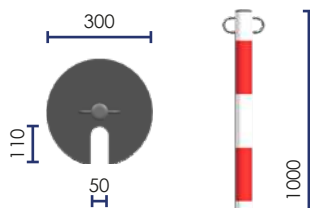

**INCLUS** ◦ **INCLUDED** ◦ **INCLUIDO** ◦ **INKLUSIVE**



Protection  
 Protection  
 Protección  
 Schutzplatte

**OPTION** ◦ **OPTIONAL** ◦ **OPCIÓN** ◦ **OPTIONAL**

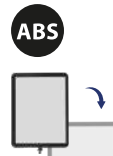
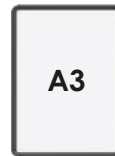

TUBEKO 100 RB  
 + BBASE 40

BEKO 100

**POTEAUX D'INFORMATION** ◦ **INFORMATION POST**  
**POSTE DE INFORMACIÓN** ◦ **INFO STÄNDER**

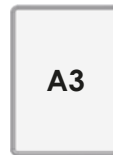

BSA 1004



BSA 1003



BKI 1004

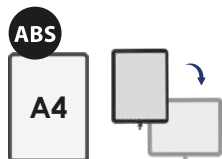

Code	
BKI 1004 RB	
BKI 1004 NJ	
BKI 1004 B	

A4

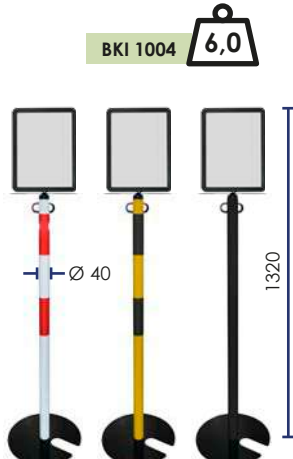

Code		
BSA 1004 RB		A4
BSA 1004 NJ		
BSA 1004 B		
BSA 1004 N		
BSA 1004 AISI		
BSA 1003 RB		A3
BSA 1003 NJ		
BSA 1003 B		
BSA 1003 N		
BSA 1003 AISI		







Créa Luxe.fr

## CHAINE ACIER ET ACCESSOIRES ◦ STEEL CHAIN AND ACCESSORIES CADENA DE ACERO Y ACCESORIOS ◦ STAHLKETTEN UND ZUBEHÖR

DIN 236 NB

CDI 236 NB



DVD 350

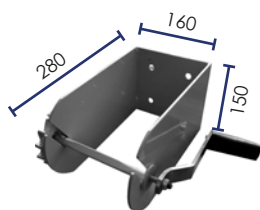

Avec blocage - Livré sans fixation  
With stop - No fixation included  
Con bloqueo - No incluye fijaciones  
Mit Blockierung - Ohne Fixierung



Ø 6

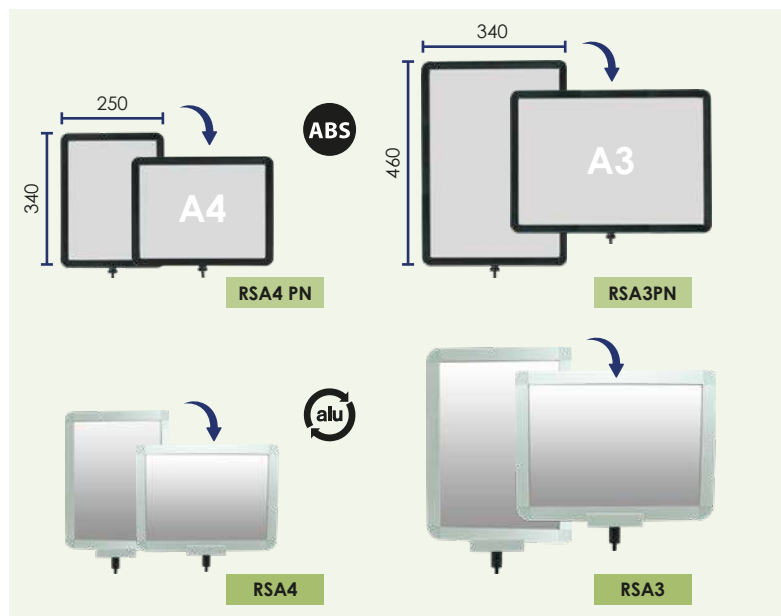

Ø 6



Ø 6

Code	*		↔	kg
DIN 236 NB	2	●		16,5
CDI 236 NB	1	●	25 m	17
NAU 64 NB	3	●		20
DIN 233 RB CT	4	●		9,3
DIN 233 NJ CT	4	●	15 m	9,3
DIN 233 BL CT	4	○		9,3
CDCH 25 SB	5	●		1,4
DIN 225 RB SB	4	●		1,7
DIN 225 NJ SB	4	●	2 m	1,7
DIN 225 B SB	4	○		1,7
DIN 225 N SB	4	●		1,7



Code	*		
MRA 602 NS	2	●	x 2
MRI 602 NS	1	●	x 2
MRAR 604 SB	4	●	x 4
MRAN 604 SB	4	●	x 4

Code	*		
ESS 582 NP	2	●	x 2
ESI 502 NS	1	●	x 2
ESR 584 SB	4	●	x 4
ESW 584 SB	4	○	x 4
ESN 584 SB	4	●	x 4
ESNJ 584 NS	4	●	2 ● + 2 ●

MDI 602 NS



MAN 602 NS



CPF 80 E



APV 80 E



\*

- 1 ▷ Inox ◦ Stainless steel ◦ Acero inoxidable ◦ Nichtrostend
- 2 ▷ Zingué ◦ Zinc ◦ Zincado ◦ Verzinkte
- 3 ▷ Galva à chaud ◦ Galvanized steel ◦ Acero galvanizado ◦ Nichtrostend
- 4 ▷ Epoxy
- 5 ▷ Chromé ◦ Chromed ◦ Cromado ◦ Verchromte



POW 01 RB

POM 01 RB

**POTEAUX SÉRIE LOURDE** ○ **HEAVY DUTY POST**  
**POSTES ALTA RESISTENCIA** ○ **METALL PFOSTEN – « BIG » AUSFÜHRUNG**



PEINTURE ÉPOXY  
 POWDER PAINTING  
 PINTURA EPOXICA  
 EPOXY FARBE

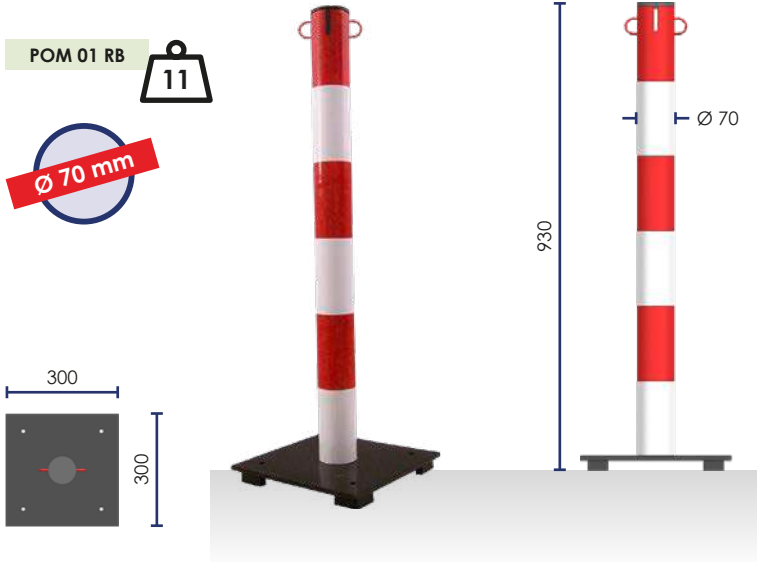

DIN 233 RB CT



DIN 225 RB SB

Ø 6

Code	*			
DIN 233 RB CT	4		15 m	9,3
DIN 225 RB SB	4		2 m	1,7

\* 4 ▷ Epoxy

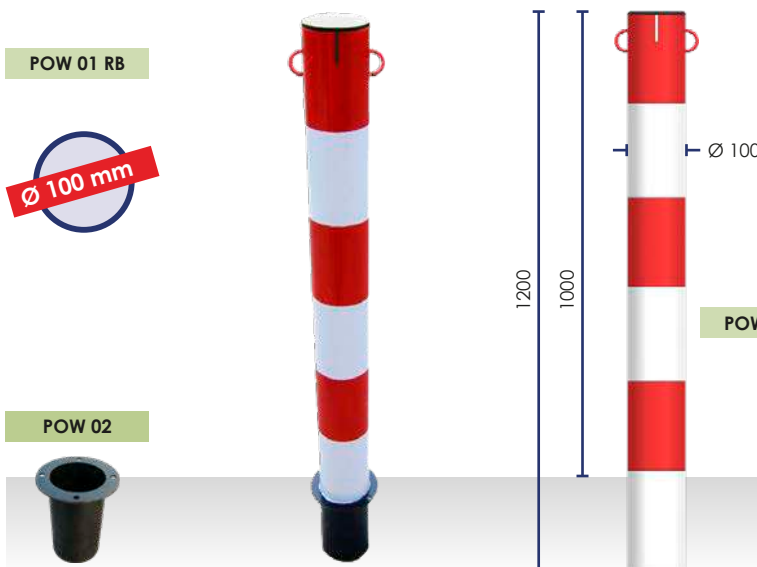

POW 01 RB



POW 02

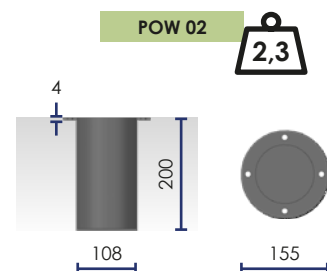

POW 02











**FLEXP**

**EXTENSO**

**BARRIÈRE EXTENSIBLE** ◦ **EXPANDABLE BARRIER**  
**BARRERA EXTENSIBLE** ◦ **ABSPERR-SCHERENGITTER**



**FLEXP** ◀▶ 2,00 m

Code		kg
FLEXP 200 RB		4,80
FLEXP EXTRB		3,40
FLEXP 200 NJ		4,80
FLEXP EXTNJ		3,40

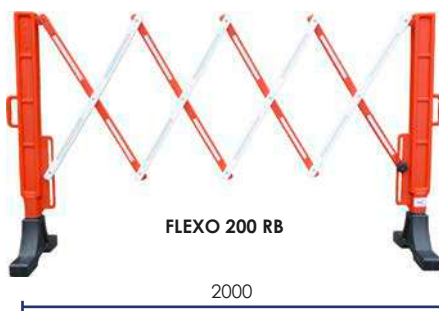
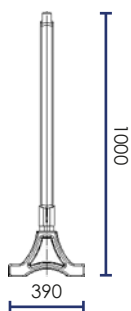

FLEXP 200 RB

2000

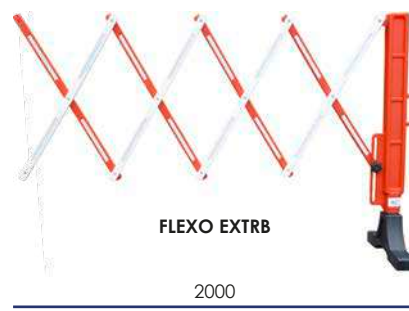

FLEXP EXTRB

2000

**EXTENSO** ◀▶ 2,40 m

Code		kg
EXTENSO		7,50
EXTENSO JA		7,50



5 x 2 = 10 L

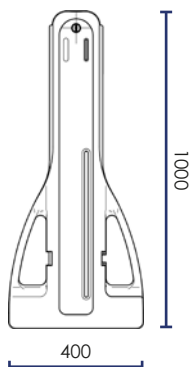
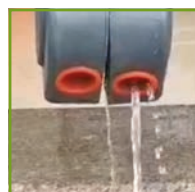

200

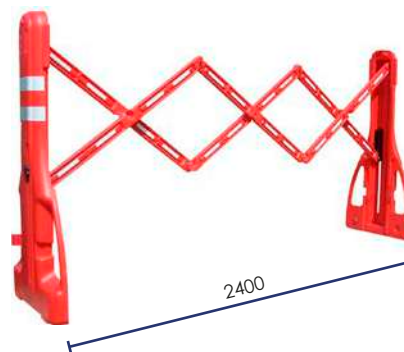

2400

OPTION ◦ OPTIONAL ◦ OPCIÓN ◦ OPCIÓNAL



FLASH 90



LAMP SOL 180





# BAR 3000

## BARRIÈRE EXTENSIBLE ◦ EXPANDABLE BARRIER BARRERA EXTENSIBLE ◦ SCHERRENSPERREN

3,00 m



Code	
BAR 3000 RB	
BAR 3000 BK	
BAR 3 EXT RB	
BAR 3 EXT BK	

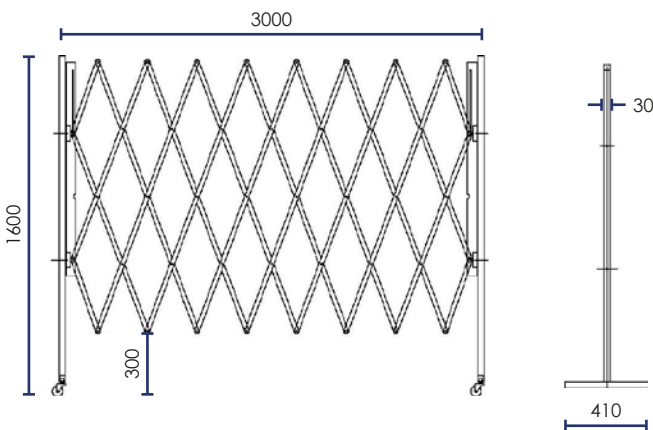
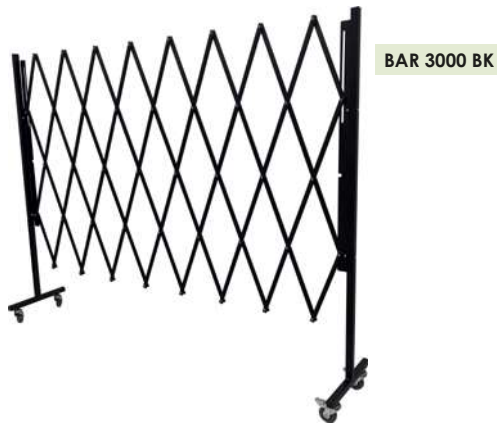



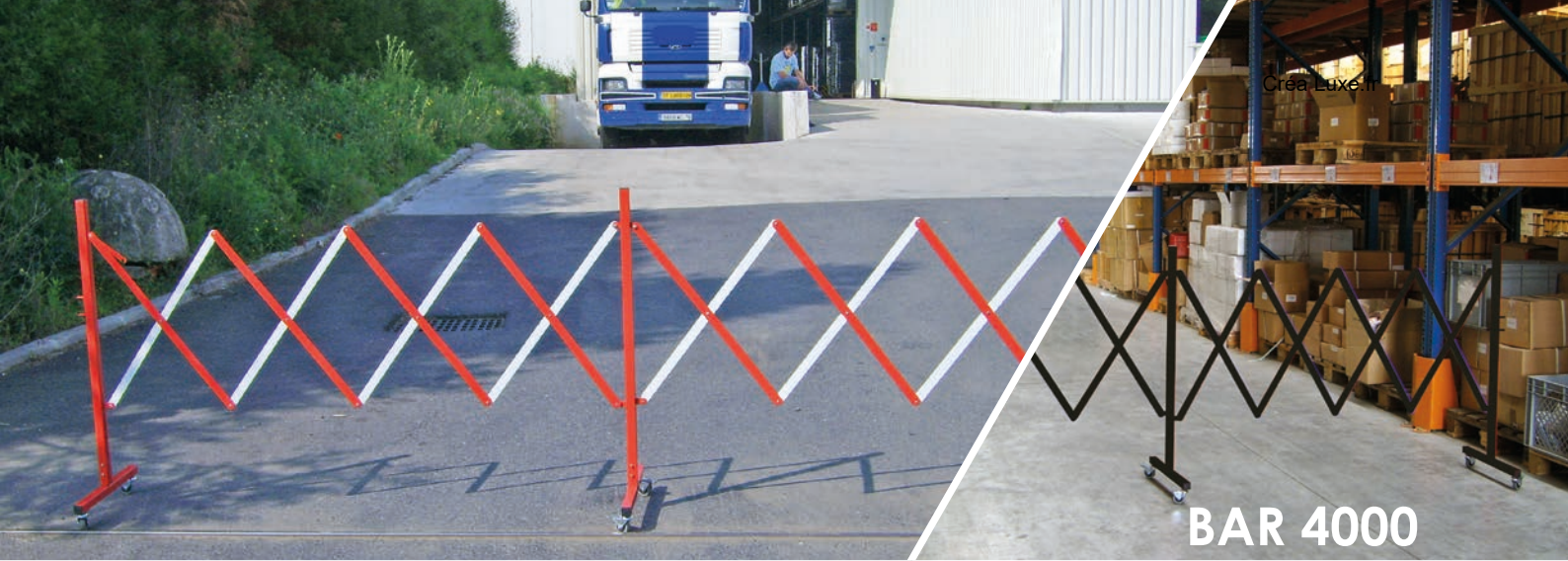

BAR 4000

**BARRIÈRE EXTENSIBLE** ◦ **EXPANDABLE BARRIER**  
**BARRERA EXTENSIBLE** ◦ **SCHERRENSPERREN**

4,00 m



Code	
BAR 4000	
BAR 4000 NJ	
BAR 4000 BK	

16

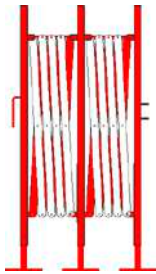

BAR 4000

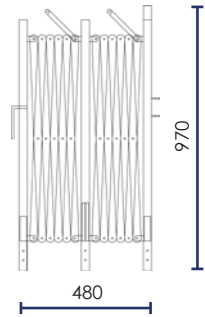
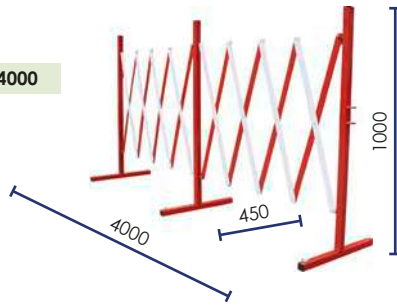

Code	
BAR 4000 FIX	
BAR 4000 NJ FIX	
BAR 4000 BK FIX	

18

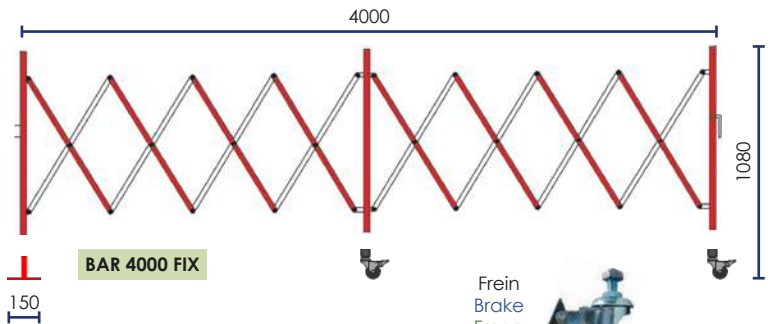

BAR 4000 FIX

Frein  
 Brake  
 Freno  
 Bremse

WH 501 SB  
 Ø 50 mm



Code	
BAR 4006 RB	
BAR 4006 NJ	
BAR 4006 BK	

17



BAR 4006 RB

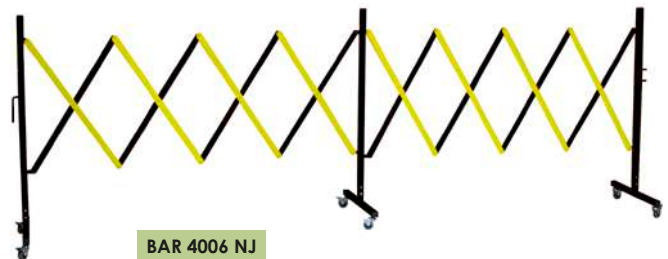

BAR 4006 NJ

**OPTION** ◦ **OPTIONAL** ◦ **OPCIÓN** ◦ **OPTIONAL**

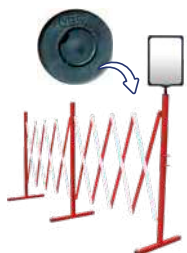

A4  
 RS A4 PN

A3  
 RS A3 PN

ABS

Frein  
 Brake  
 Freno  
 Bremse

WH 501 SB  
 Ø 50 mm

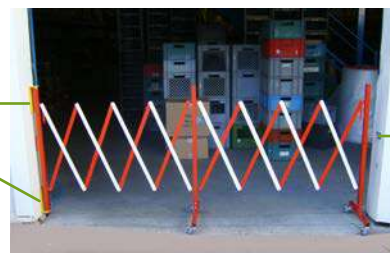

BAR 4 KIT

Kit de fixation murale ◦ Wall fixing kit  
 Kit de fijación a la pared  
 Wandbefestigungsset



# coffee

COMPTOIR DES ARÔMES

Créa Luxe.fr

SUCRE ET  
TOUILLETTE  
DISPONIBLES  
EN CAISSE

PORT DU MASQUE  
OBLIGATOIRE  
Même de votre côté



NOTRE CARTE  
TOUTES LES  
MIGNARDISES  
À  
PRIX  
MINI

NOTRE CARTE  
TOUTES LES  
MIGNARDISES  
À  
PRIX  
MINI

NOTRE CARTE  
TOUTES LES  
MIGNARDISES

SIMPLE ET PRATIQUE  
COMME LE PAIEMENT  
SANS CONTACT !  
FAITES DES  
ÉCONOMIES !







**PARAVENT  
/ BARRIÈRE DE PROTECTION**

- Auto portante
- 2 hauteurs : 1 m ou 1,80 m
- En 3 vantaux
- Inox ou PVC
- Repliable
- Tissus à assembler sur l'armature par le client
- Tissu imprimé 1 face.
- Panneaux décoratifs avec velcro :
  - ▷ Facile à mettre en place
  - ▷ Facile à tendre
  - ▷ Tissus lavables
- Option
  - ▶ Tissu Ignifugé, impression 3 couleurs
  - ▶ Tissu brise vent, impression 3 couleurs
  - ▶ Autre couleur de Tissu (Mini. 15 barrières)
  - ▶ Personnalisation quadri (tissu standard)
  - ▶ Sac de transport

**SCREEN  
/ PROTECTION BARRIER**

- Self Standing
- 2 heights: 1 m or 1.80 m
- In 3 panels
- Stainless steel or PVC
- Foldable
- Fabrics to be mounted on the frame by the customer
- 1 side printed fabric
- Decorative panels with velcro :
  - ▷ Easy to put in place
  - ▷ Easy to stretch
  - ▷ Washable fabrics
- Optional
  - ▶ Flame retardant fabric, 3 colors printing
  - ▶ Windproof fabric, 3 colors printing
  - ▶ Other color of Fabric (Mini 15)
  - ▶ Customization 4 colors (standard fabric)
  - ▶ Transport bag

**BIOMBO  
/ BARRERA DE SEÑALIZACIÓN**

- Estructura autoportante
- 2 alturas: 1 m o 1,80 m
- De 3 paneles
- Acero inoxidable o PVC
- Plegable
- Armados de los tejidos en el marco por el cliente
- Tejido impreso a 1 cara
- Paneles decorativos con velcro:
  - ▷ Fácil de colocar
  - ▷ Fácil de tender
  - ▷ Tejidos lavables
- Opción
  - ▶ Tejido ignífugo impresión a 3 colores
  - ▶ Tejido cortaviento impresión a 3 colores
  - ▶ Otro color de tejido (Mini 15)
  - ▶ Impresión a 4 colores (tejido estándar)
  - ▶ Bolsa de transporte

**SCHUTZ BARRIÈRE  
/ SICHTSCHUTZ**

- Freistehend
- Höhe : 1m oder 1,8m
- 3 Sicht- / Schutzfelder
- Ständer Ausführung in Stahl oder Kunststoff
- Faltbar
- Montage der Elemente vor Ort durch Kunden
- 1 Seite ist bedruckt.
- Bespannung mit Klettverschluss :
  - ▷ einfach zu montieren
  - ▷ ist dehnbar
  - ▷ waschbar
- Optional
  - ▶ Flammfestes Gewebe 3 Farben-Druck
  - ▶ Windiges Gewebe 3 Farben-Druck
  - ▶ Andere Farbversion (Mind. 15 Stück)
  - ▶ 4 Farben-druck (standard gewebe)
  - ▶ Transporttasche





**ENR 200**

**BARRIÈRE AVEC ENROULEUR** ◦ **EXPANDABLE / RETRACTABLE BARRIER**  
**BARRERA DE SEÑALIZACIÓN CON ENROLLADOR** ◦ **EINZIEHBARE ABSPERROLLE**

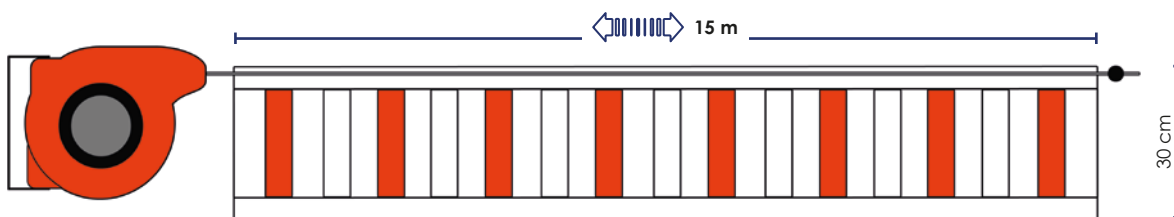

390 x 120 x 270  4.0



**ENR 200 OR**  
 Réflechissant  
 Reflective  
 Reflektivo  
 Reflektierend

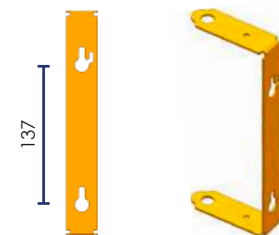

**ENR 200 RB**



**ENR 200 NJ**

**INCLUS** ◦ **INCLUDED**  
**INCLUIDO** ◦ **INKLUSIVE**



**OPTION** ◦ **OPTIONAL** ◦ **OPCIÓN** ◦ **OPTIONAL**

**ENR 200 ROUTE**  
 87 x 28 cm

**ROUTE BARREE**

**ENR 200 ACCES**  
 87 x 28 cm

**ACCES INTERDIT**

**ENR 200 SI**  
 29 x 27 cm





ENR 200

**OPTIONS** ○ **OPTIONS** ○ **OPCIONES** ○ **OPTIONEN**

**ENR BOX**

500 x 200 x H 480



Porte coulissante  
Sliding door  
Puerta corrediza  
Schiebetürsystem



**ENR POST 140**



Poteau support et récepteur  
Fixing post and receiver  
Poste soporte y receptor  
Doppelte Funktion: Träger und Empfänger

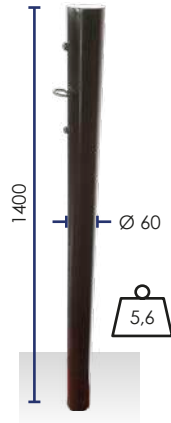

**BASE 2500**

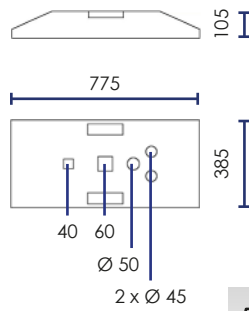

ENR 200 + BBASE

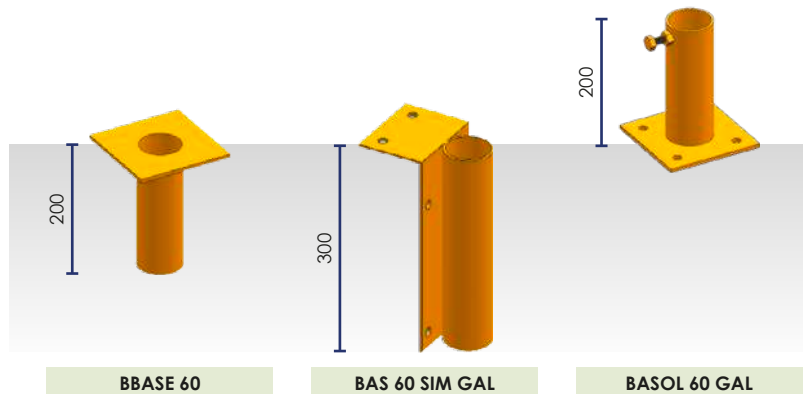

BBASE 60

BAS 60 SIM GAL

BASOL 60 GAL





RSNA

CHAINE

## RUBAN DE SIGNALISATION

WARNING TAPE ◦ CINTA DE SEÑALIZACIÓN ◦ ABSPERRBÄNDER



### IMPRESSION 1 FACE ◦ 1 SIDE PRINTING ◦ IMPRESIÓN 1 CARA ◦ 1-SEITIG BEDRUCKEN

Code	
RSNA 01 RB	x 36
RSNA 121 RB	x 12
RSNA 01 NJ	x 36
RSNA 121 NJ	x 12
RSNA 01 VE	x 36
RSNA 121 VE	x 12

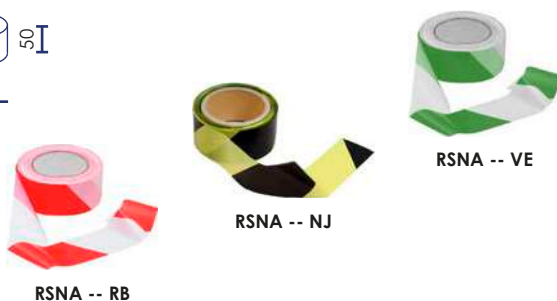
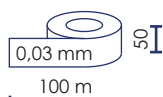

### IMPRESSION 2 FACES ◦ 2 SIDES PRINTING ◦ IMPRESIÓN 2 CARAS ◦ 2-SEITIG BEDRUCKEN

Code	
RSNA 02 RB	x 36

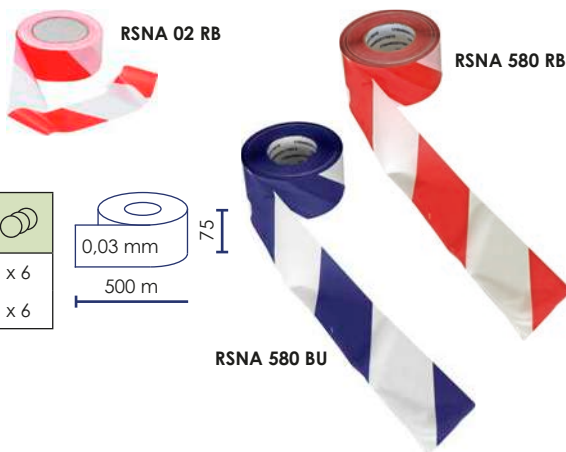
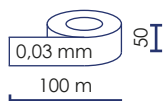

Code	
RSNA 580 RB	x 6
RSNA 580 BU	x 6

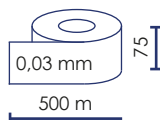

#### ACCESSOIRES ◦ ACCESSORIES ACCESORIOS ◦ ZUBEHÖR

PFER 520 SB



x 20



SP 1205 SB

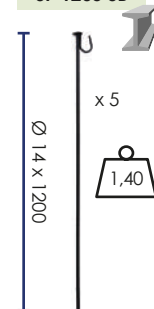

## CHAINE POLYPRO

POLYPROPYLENE CHAIN ◦ CADENA DE PLÁSTICO ◦ KUNSTSTOFFKETTEN



Code	
CFLUO 825 SBS	○
CNJ 801 SBS	●
CBR 801 SBS	●
CPB 801 SBS	○
CPR 801 SBS*	●
CBV 801 SBS	●
CBB 801 SBS	●
CPN 801 SBS	●

25 m - Ø 8



Accessoires ▶ p. 175  
Accessories ▶ p. 175  
Accesorios ▶ p. 175  
Zubehör ▶ p. 175

\* Epuisement stock ◦ While stock lasts ◦ Hasta agotar existencias ◦ Lagervorrat Begrenzung





GUI 200

GUI 500

**BANDEAU DE SIGNALISATION TISSU** ○ HIGH VISIBILITY WARNING STRIP  
**BANDA DE ADVERTENCIA ALTA VISIBILIDAD** ○ **BAND MIT HOHER SICHTBARKEIT**



5 M



Bandes lestées  
 Weighted bottom  
 Bandas lastradas  
 unten des Bands gewichtet

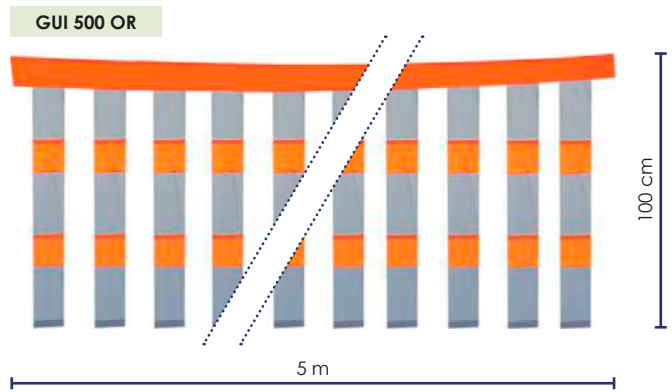

20 M



Bandes réfléchissantes  
 Reflective tapes  
 Tiras reflectantes  
 Reflektierende Streifen

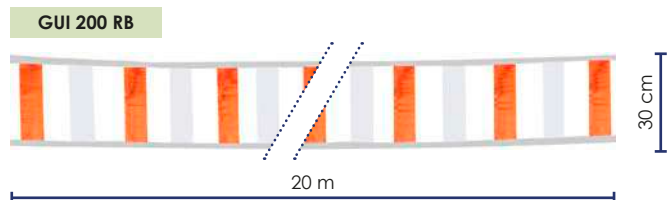
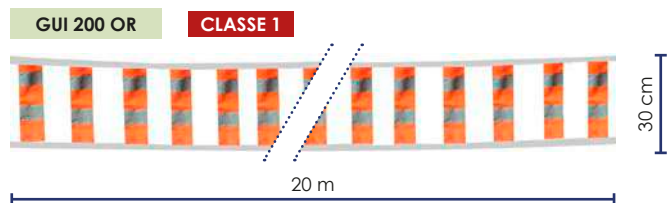

**INCLUS** ○ INCLUDED ○ INCLUIDO ○ INKLUSIVE



Sac de rangement  
 Storage bag  
 Bolsa de almacenamiento  
 Aufbewahrungstasche

**OPTION** ○ OPTIONAL ○ OPCIÓN ○ OPTIONAL

ENR 200 ROUTE  
 87 x 28 cm

**ROUTE BARREE**

ENR 200 ACCES  
 87 x 28 cm

**ACCES INTERDIT**

ENR 200 SI  
 29 x 27 cm







**RUBAN DE BALISAGE** ◦ MARKING TAPE ◦ CINTA DE SEÑALIZACIÓN ◦ BODENMARKIERUNG

**ADHÉSIF** ◦ ADHESIVE ◦ ADHESIVO ◦ KLEBSTOFF

Code		
RSA 335 STOP NJ		x 6
RSA 335 NJ		x 6
RSA 335 RB		x 6



RSA 335 STOP NJ



RSA 335 NJ



RSA 335 RB



**ANTI-DÉRAPANT** ◦ NON SKID ◦ ANTIDESLIZANTE ◦ ANTIRUTSCH VERSION

Code		
RSA 550 BK		x 6
RSA 550 NJ		x 6
RSA 550 RB		x 6
RSA 550 BYB		x 6

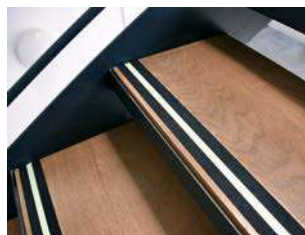
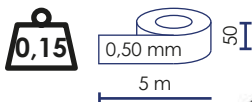

RSA 550 BYB

Code		
RSA 5100 BK		x 1
RSA 5100 NJ		x 1

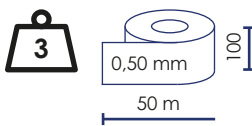

RSA 5100 BK



**RÉFLÉCHISSANT ET ANTI-DÉRAPANT \*** ◦ NON SKID AND REFLECTIVE  
REFLECTIVO Y ANTIDESLIZANTE ◦ REFLEKTIEREND & ANTIRUTSCH VERSION

Code		
RSNT 100 JA		x 1
RSNT 100 BL		x 1
PODGLUE2 *		

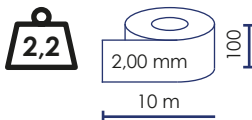

\* A poser avec colle ◦ To fix with glue ◦ Usar pegamento ◦ Befestigung durch Kleber



Colle époxydique souple 2 composants pour béton  
Flexible 2-component epoxy adhesive for concrete  
Adhesivo epoxidico flexible de 2 componentes para hormigón  
2-Komponenten Kleber für Beton







PDM

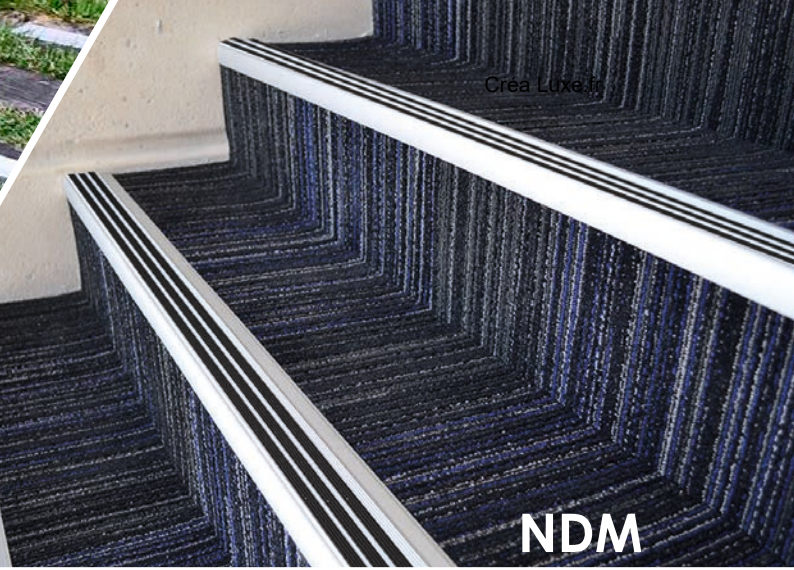

NDM

**NEZ DE MARCHE ANTIDÉRAPANT** ○ NON-SLIP STAIR NOSING  
**PERFIL ANTIDESLIZANTE PARA PELDAÑOS** ○ RUSTCHFEST TREPPENKANTENPROFIL



Code			
NDM 900 PVC	●	3 x 5 mm	0,80
NDM 900 BK	●		0,80
NDM 900 FLUO	●		0,80
NDM 1300 PVC	●	4 x 5 mm	1,20
NDM 1300 BK	●		1,20
NDM 1300 FLUO	●		1,20

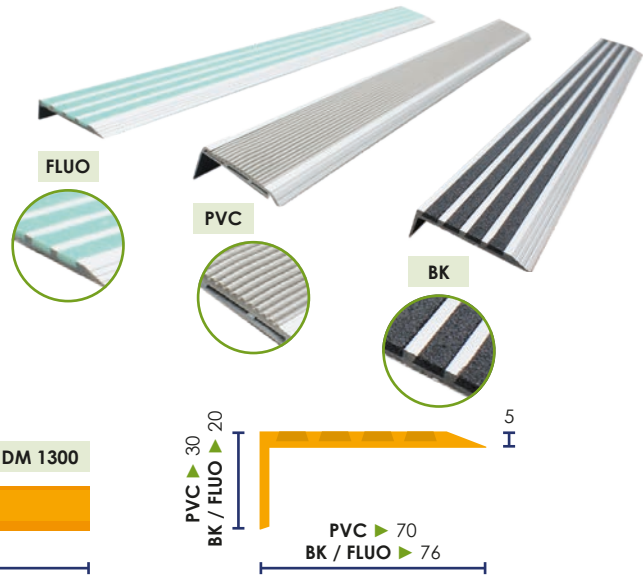

non fourni ○ not supplied ○ no incluido ○ nicht enthalten

NDM 900

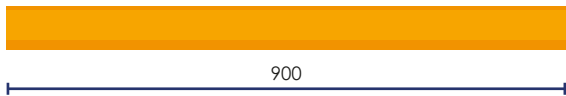

NDM 1300

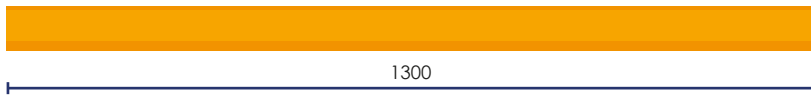

**PLAT DE MARCHE** ○ STAIRS PAD  
**PERFIL ANTIDESLIZANTE PARA PELDAÑOS** ○ TREPPENKANTEN



Code			
PDM 900 PVC	●	3 x 5 mm	0,80
PDM 900 BK	●		0,80
PDM 1300 PVC	●	4 x 5 mm	1,10
PDM 1300 BK	●		1,10

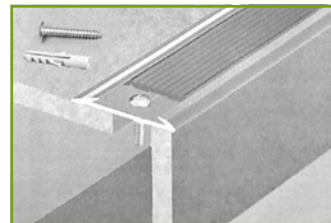

non fourni ○ not supplied ○ no incluido ○ nicht enthalten

PDM 900

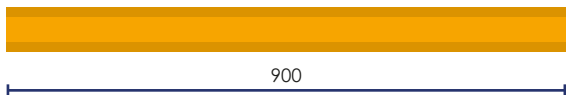

PDM 1300

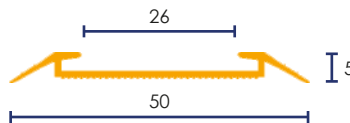
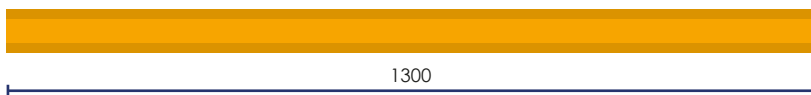

OPTION  
 OPCION  
 OPTIIONAL



RQ GLUE





SOLEX

**ADHÉSIF POUR MARQUAGE AU SOL EXTÉRIEUR**  
**OUTDOOR WARNING FLOOR STICKER**  
**ADHESIVO DE MARCADO PARA USO EXTERIOR**  
**BODENMARKIERUNGEN EXTERNE ANWENDUNG**

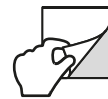

**ANTI-DÉRAPANT**

NON SKID ◦ ANTIDESLIZANTE ◦ ANTIRUTSCH VERSION



Impression sur vinyle adhésif antidérapant spécialement conçu pour asphalte, trottoirs ou béton.

Printing on non-slip adhesive vinyl specially designed for asphalt, sidewalks or concrete.

Impresión sobre vinilo adhesivo antideslizante especialmente diseñado para asfalto, aceras u hormigón.

Druck auf rutschfestem Klebevinyl speziell für Asphalt, Gehwege oder Beton.



**SOLEX 305 FLEC**

30 x 5 cm

x 5

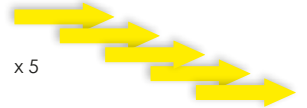

**SOLEX 280 PAS**

28 x 10 cm

x 10 (5 + 5)



**SOLEX 845 PERS**

80 x 45 cm

x 2



**SOLEX 560 HAND**

600 x 500



**SOLEX 500 STAT**

Ø 500



**SOLEX 500 OBLI**

Ø 500



**SOLEX 500 PIET**

Ø 500



**SOLEX 500 SENS**

Ø 500



**SOLEX 100 ZEBRA**

100 x 25 cm

x 3

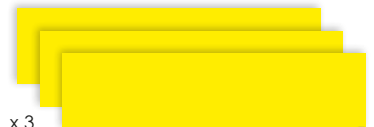

**SOLEX 453 CHUT**

45 x 35 cm



**SOLEX 453 TOMB**

45 x 35 cm







Casa Luxe.fr

SAN 500

# ADHÉSIF POUR MARQUAGE AU SOL INTÉRIEUR

INDOOR WARNING FLOOR STICKER

ADHESIVO DE MARCADO PARA USO INTERIOR

WARN- & VERBOTSSCHILDER BODEN INNENBEREICH

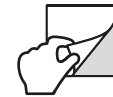

## STANDARD

## ANTI-DÉRAPANT

NON SKID

ANTIDESLIZANTE

ANTIRUTSCH VERSION



SOL 350 RSTOP

Ø 350



SOL 500 RCHAR

Ø 500



SOL 500 RFUM

Ø 500



SOL 500 RINT

Ø 500



SOL 500 ROBLI

Ø 500



SOL 500 RPIET

Ø 500



SOL 500 RSENS

Ø 500



SAN 500 TCHAR

500 x 500 x 500



SAN 500 TELEC

500 x 500 x 500



SAN 500 TGLIS

500 x 500 x 500



SAN 500 CEXT

500 x 500







**WALL 1200**



**WARN 1200**

**RAMPE DE PORTAIL**

**GATE RAMP** ◦ **RAMPA DE ENTRADA** ◦ **EINFahrtschwelle VOR EINEM TOR**

CAOUTCHOUC  
RUBBER  
CAUCHO  
KAUSCHUK

WARN 1200

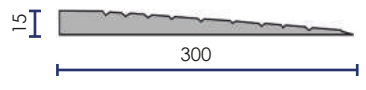
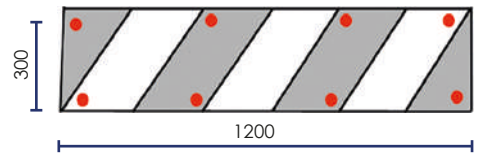

OPTION ◦ OPTIONAL ◦ OPCIÓN ◦ OPTIONAL



FSAFE  
x 8



RQ GLUE

**SIGNALISATION DE VIRAGE / PARKING**

**PARKING RAMP SIGN** ◦ **SEÑAL PARA APARCAMIENTO** ◦ **SIGNALISIERUNG**

CAOUTCHOUC  
RUBBER  
CAUCHO  
KAUSCHUK

WALL 1200



x 15  
Réflecteurs  
Eye cats  
Reflectores  
Reflektoren

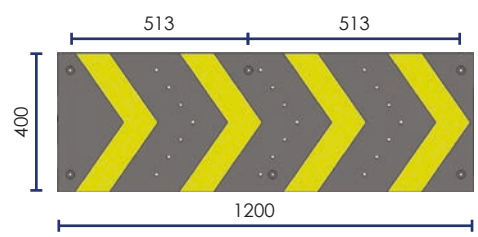

INCLUS ◦ INCLUDED ◦ INCLUIDO ◦ INKLUSIVE



x 6



x 15





Collectivités ◦ Welcome





A series of horizontal lines for writing, starting from the top line and extending down to the bottom of the page.

BURGER & STEAK HOUSE

Oréal Luxe.fr

OLE

PEPPERICO

TAPASANA

Début de la file d'attente FNAC.

Merci de respecter les distances de sécurité

Merci de respecter les distances de sécurité

file d'attente FNAC

Ensemble, bientôt

Westfield VÉLIZY 2







**COMMENT CHOISIR SON POTEAU ?** ◦ HOW TO CHOOSE YOUR STANCHION?  
 ¿CÓMO ELEGIR SU POSTE? ◦ WIE WÄHLEN SIE IHREN PFOSTEN AUS?

**1. INTÉRIEUR OU EXTÉRIEUR ?** ◦ INDOOR OR OUTDOOR ?  
 INTERIOR ◦ EXTERIOR ? ◦ ANWENDUNG: INNEN ODER AUSSEN?



**2. JE CHOISIS LA LONGUEUR ET LA LARGEUR DE MA SANGLE**  
 I CHOOSE THE LENGTH AND WIDTH OF MY BELT ◦ ELIJO EL LARGO Y EL ANCHO DE MI CINTA  
 DIE BREITE UND LÄNGE DES ABSPERRBANDES WÄHLEN

INTÉRIEUR ◦ INDOOR ◦ INTERIOR ◦ INNEN



EXTÉRIEUR ◦ OUTDOOR ◦ EXTERIOR ◦ AUSSEN

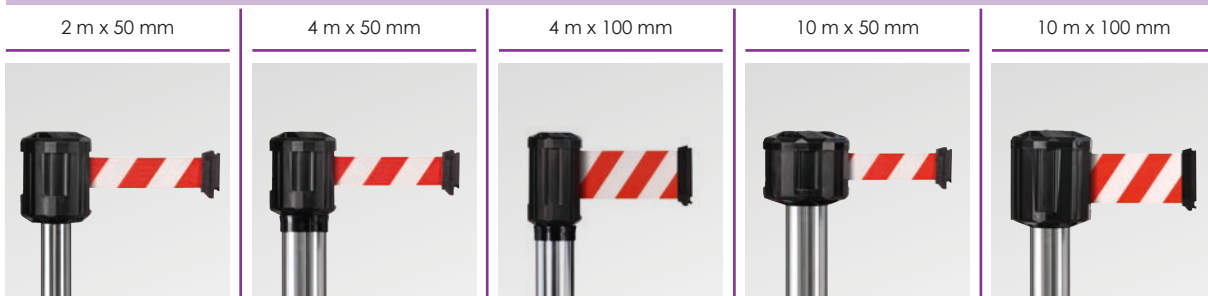



**3. JE CHOISIS LA COULEUR DE MA SANGLE** ◦ I CHOOSE THE COLOR OF MY BELT  
 ELIJO EL COLOR DE MI CINTA ◦ DIE FARBE DES BANDES AUSWÄHLEN

2 M X 50 MM 4 M X 50 MM 4 M X 100 MM 10 M X 50 MM 10 M X 100 MM Sangle freinée Braked strap Cinta frenada Absperrgurt mit Bremsvorrichtung						
	<b>BU</b>	<b>VE</b>	<b>RE</b>	<b>JA</b>	<b>GR</b>	<b>BK</b>
						
	<b>RB</b>	<b>NJ</b>	<b>ENT</b>	<b>STOP</b>		
						
	<b>DAN</b>	<b>BYB</b>	<b>BBR</b>	<b>IS</b>		

▲ Sangle personnalisée, nous consulter ◦ Customized belt, consult us.  
 Cinta personalizada, consultarnos ◦ Gurt Personalisierung, uns konsultieren.



**4. JE CHOISIS LA COULEUR DE MON TUBE** ◦ I CHOOSE THE COLOR OF MY TUBE  
 ELIJO EL COLOR DE MI TUBO ◦ DIE FARBE DES STÄNDERS AUSWÄHLEN

										
<b>BK</b>	<b>GR</b>	<b>SR</b>	<b>RB</b>	<b>RE</b>	<b>OR</b>	<b>JA</b>	<b>NJ</b>	<b>VE</b>	<b>BU</b>	<b>WH</b>





**5. JE CHOISIS MA BASE** ◦ I CHOOSE MY BASE  
 ELIJO MI BASE ◦ DIE BODENPLATTE AUSWÄHLEN

<p><b>ECO</b></p>	<p><b>NOMAD</b></p>
<p>2 m (2,5 kg)</p>	<p>2 m / 4 m (8 kg)</p>
	
<p><b>CLASSIC</b></p>	
<p>2 m (8,1 kg)</p>	<p>4 m (8,5 kg)</p>
	
<p><b>FIX</b></p>	<p><b>AMOVIBLE</b></p>
<p>2 m   4 m</p>	<p>2 m / 4 m</p>
	
<p><b>HEAVY</b></p>	<p><b>À LESTER</b></p>
<p>2 m / 4 m (14 kg)</p>	<p>4 m (8,3 kg *)</p>
	

\* avec de l'eau ◦ with water ◦ Con agua ◦ mit Wasser



**6. OPTION : JE CHOISIS MES ACCESSOIRES** ○ OPTION : I CHOOSE MY ACCESSORIES  
 OPCIÓN: ELIJO MIS ACCESORIOS ○ ALTERNATIVEN: ZUBEHÖR AUSWÄHLEN

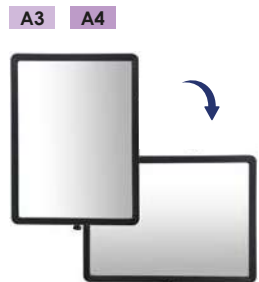
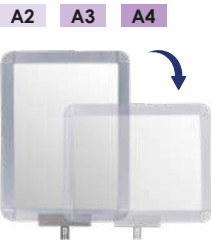

A2 A3 A4



CONNECTEUR ○ CONNECTOR  
 CONECTOR ○ VERBINDUNGSELEMENT





**RS2 \***  
Type base / longueur de sangle \*  
Base type / belt length  
Tipo base / largo cinta  
Bodenhülse / Die Länge des Absperribandes

**BK**  
Couleur poteau  
Color post  
Color poste  
Farbauswahl der Pfosten

**RE**  
Couleur sangle  
Belt color  
Color cinta  
Gurt-Farbe

**RS2BKRE**

Créa Luxe.fr

## COULEUR POTEAU ○ POST COLOR COLOR POSTE ○ FARBAUSWAHL DER PFOSTEN

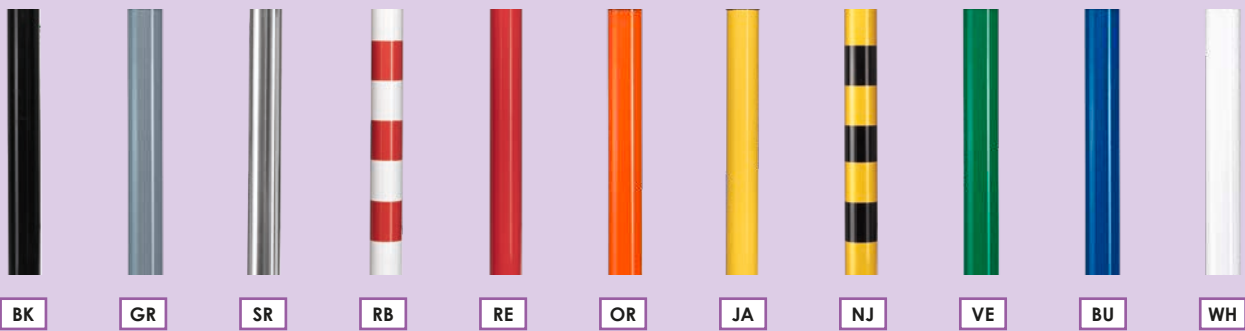

## STANDARD

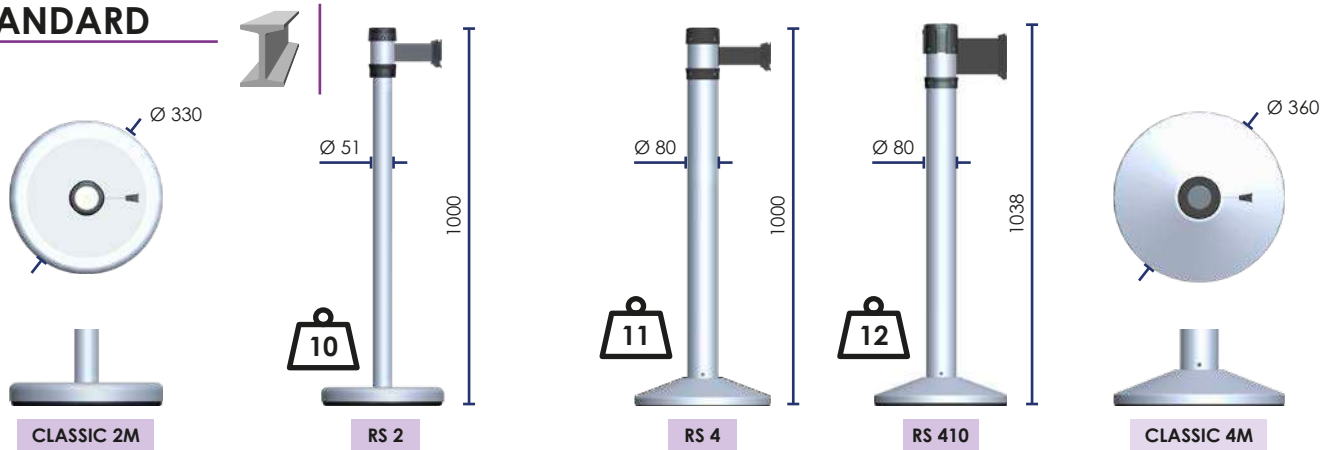

## BASE U ○ U BASE BASE EN U U-BASISPLATTE

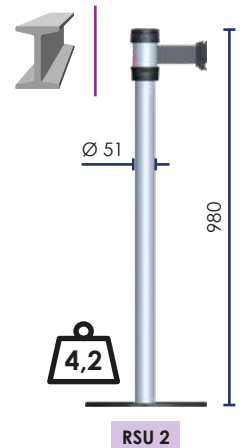
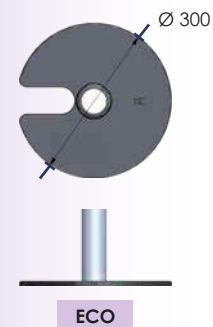



**INTÉRIEUR** Créa Luxe.fr **INDOOR**  
**INTERIOR** ◦ **INNEN AUSFÜHRUNG**

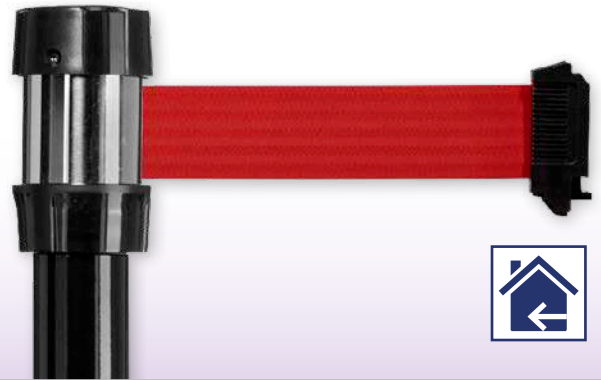

**COULEUR SANGLE** ◦ **BELT COLOR**

**COLOR CINTA** ◦ **GURT-FARBE**

2 M X 50 MM  
4 M X 50 MM

4 M X 100 MM

Sangle freinée  
Braked strap  
Cinta frenada  
Abspergurt mit  
Bremsvorrichtung



**BASE FIXE** ◦ **FIXED BASE**

**BASE FIJA**

**BODENBEFESTIGUNG FEST**

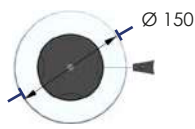

FIX

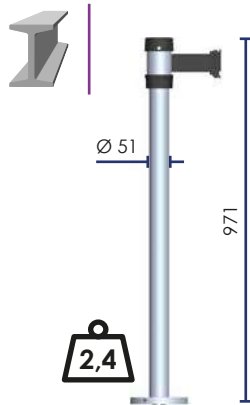

RSF 2

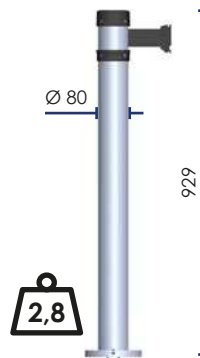

RSF 4

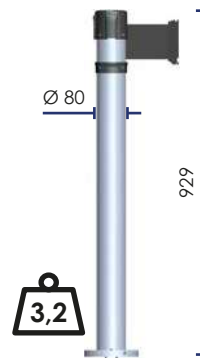

RSF 410

**AMOVIBLE** \* ◦ **REMOVABLE**

**EXTRAÍBLE** ◦ **ABNEHMBAR**

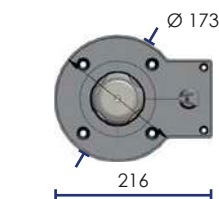

RS BOX

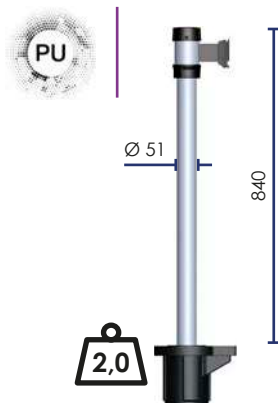

RSB 2

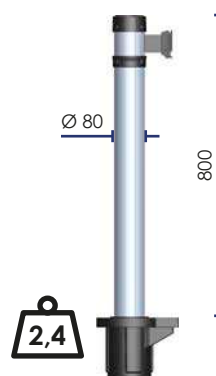

RSB 4

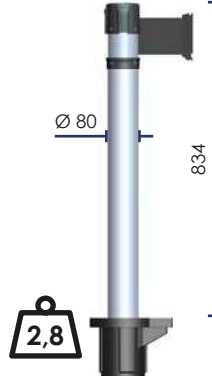

RSB 410

\* Poteau amovible ◦ Removable post ◦ Poste extraíble ◦ Abnehmbarer Pfosten



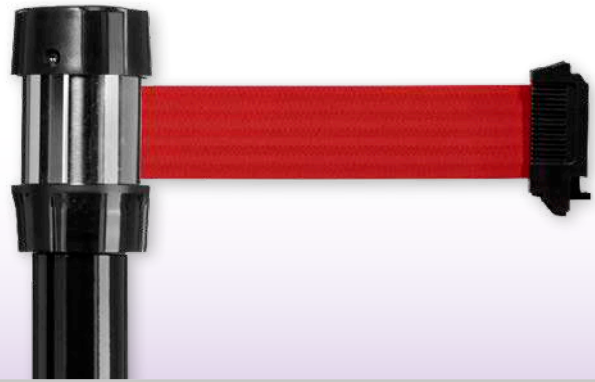

**ROULETTES** ◦ WHEELS  
 RUEDAS ◦ RUNDERFUSS



NOMAD

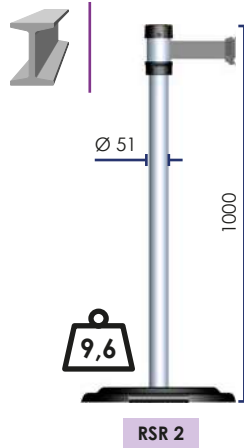

RSR 2

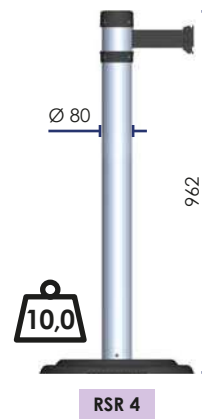

RSR 4

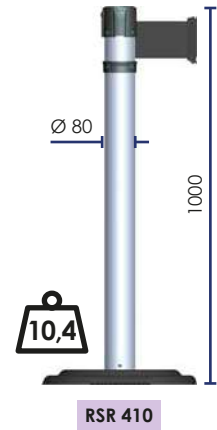

RSR 410

**HEAVY**

FONTE D'ACIER  
 IRON CAST  
 ACERO FUNDIDO  
 STAHLGUSS

- Lourde
- À roulettes
- Rangement
- Heavy
- Wheels
- Storage

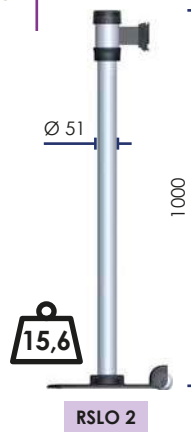
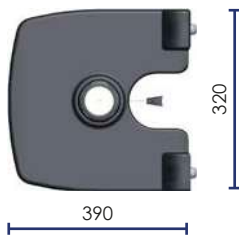

RSLO 2

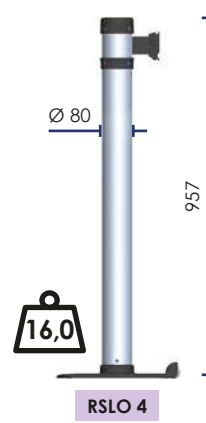

RSLO 4

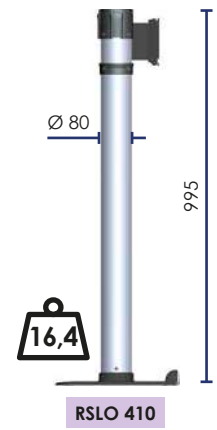

RSLO 410

**À LESTER** ◦ TO BE LOADED  
 LASTRABLE ◦ BEFÜLBAR

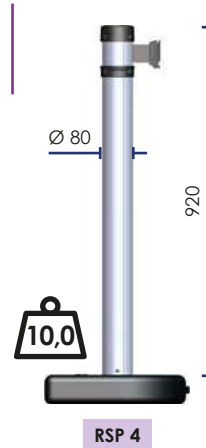

RSP 4

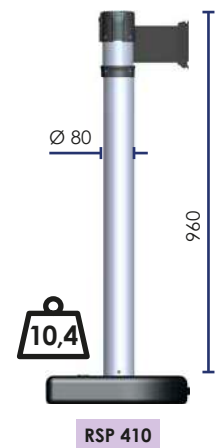

RSP 410



**INTÉRIEUR** Créa Luxe.fr **INDOOR**  
**INTERIOR**  
**INNEN AUSFÜHRUNG**



**RW**

**ENROULEUR MURAL** ◦ **WALL MOUNTED BARRIER**  
**ENROLLADOR MURAL DE CINTA** ◦ **WANDAUFROLLER**



- Enrouleur mural à sangle pour limiter facilement l'accès à une zone
- Sangle freinée
- Tête orientable
- Récepteur mural et fixations inclus
- Personnalisation de sangle sur demande

- Wall-mounted retractable belt to easily limit access to an area
- Braked strap
- Adjustable head
- Wall receiver and fixings included
- Strap customization on demand

- Enrollador mural de cinta para limitar fácilmente el acceso a un área
- Cinta con freno
- Cabezal ajustable
- Receptor de pared y fijaciones incluidos.
- Personalización de la cinta bajo pedido

- Durch den Wandaufroller kann der Zugang für bestimmte Bereiche eingeschränkt werden
- Absperrgurt mit Bremsvorrichtung
- Verstellbarer Kopf
- Inklusive Wandaufroller und Befestigungsmaterial
- Gurtlänge Änderung - auf Anfrage

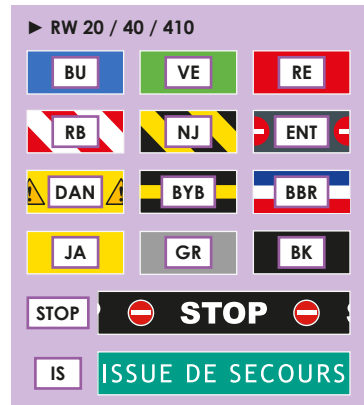
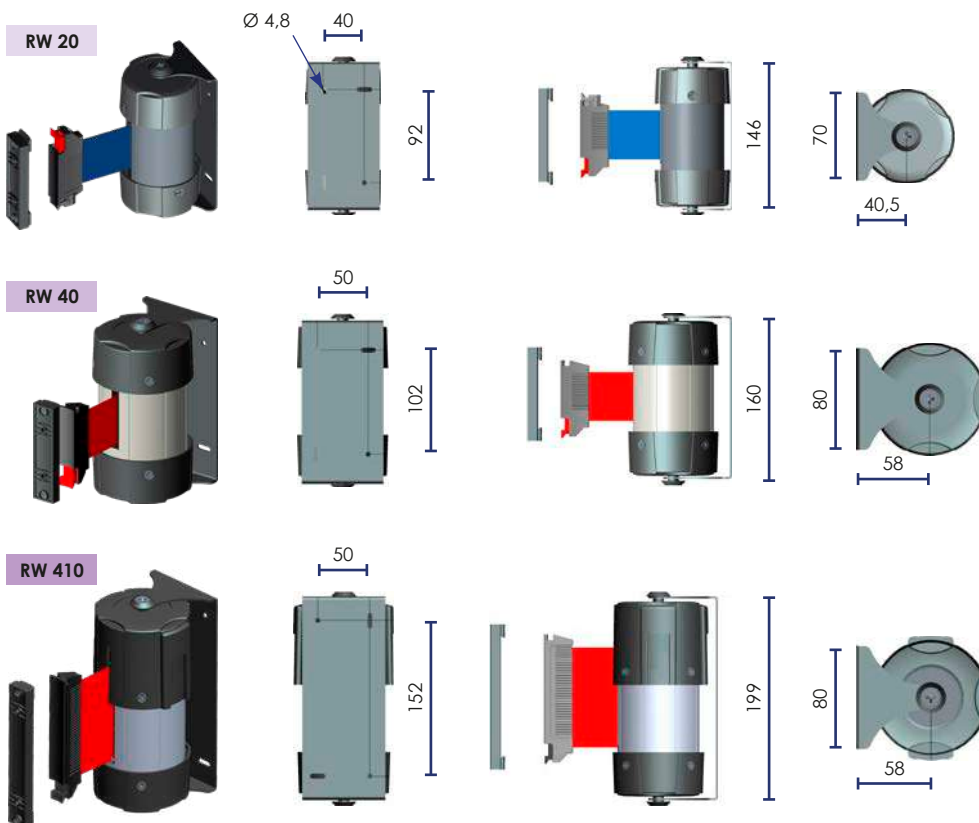

**INCLUS** ◦ **INCLUDED**  
**INCLUIDO** ◦ **INKLUSIVE**



**OPTION** ◦ **OPTIONAL**  
**OPCIÓN** ◦ **OPTIONAL**



Dispositif anti-panique  
 No panic device ◦ Dispositivo antipánico  
 Anti-Panik-Gerät

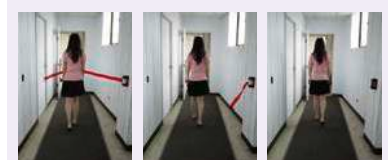





## COULEUR POTEAU ○ POST COLOR COLOR POSTE ○ FARBAUSWAHL DER PFOSTEN

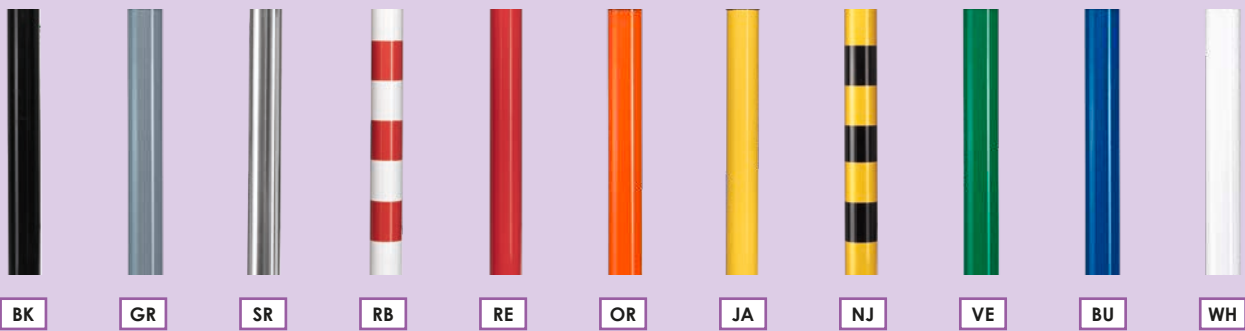

### STANDARD

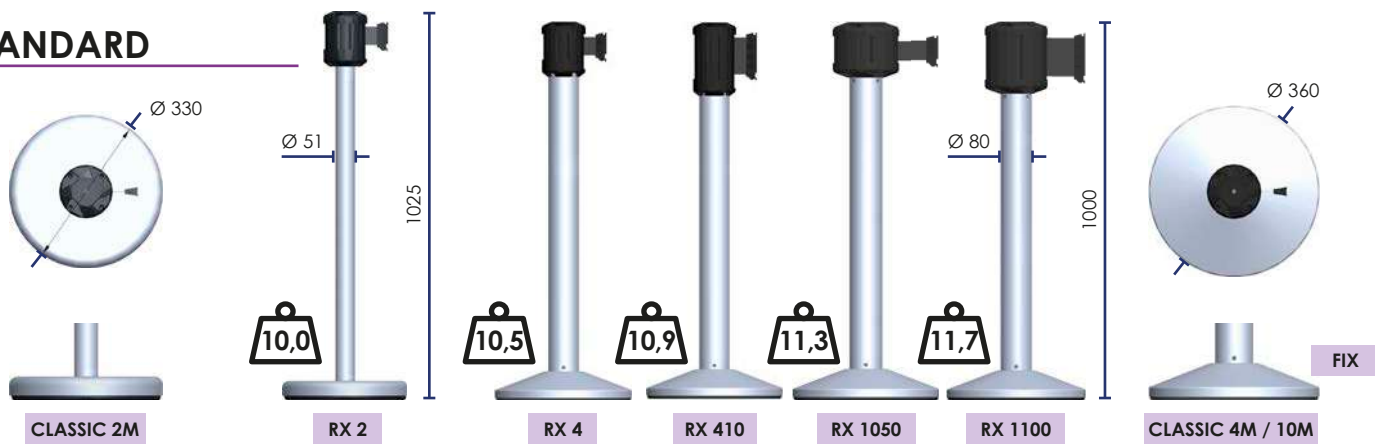

### BASE U ○ U BASE BASE EN U U-BASISPLATTE

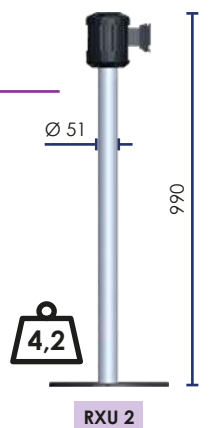
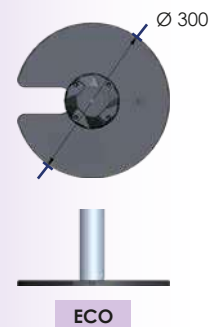

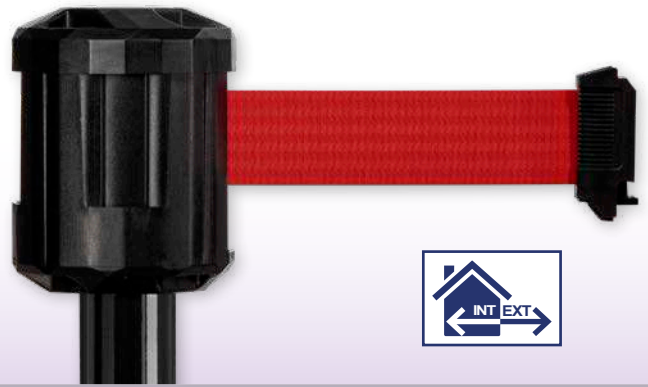

**COULEUR SANGLE** o BELT COLOR

COLOR CINTA o GURT-FARBE

2 M X 50 MM  
4 M X 50 MM

4 M X 100 MM

10 M X 50 MM

10 M X 100 MM

Sangle freinée  
Braked strap  
Cinta frenada  
Abspergurt mit  
Bremsvorrichtung



**BASE FIXE** o FIXED BASE

BASE FIJA

BODENBEFESTIGUNG FEST



FIX

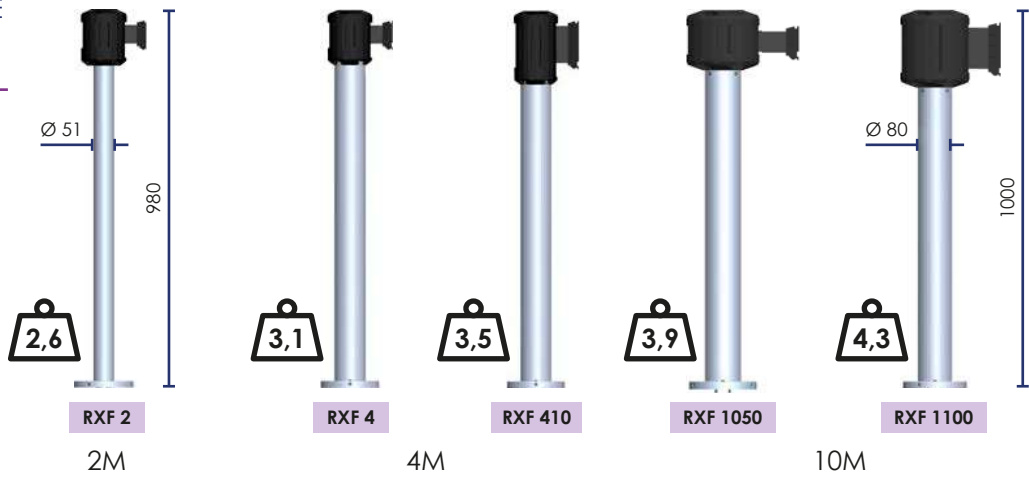

**AMOVIBLE** \* o REMOVABLE

EXTRAÍBLE o ABNEHMBAR

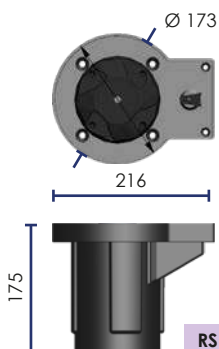

RS BOX

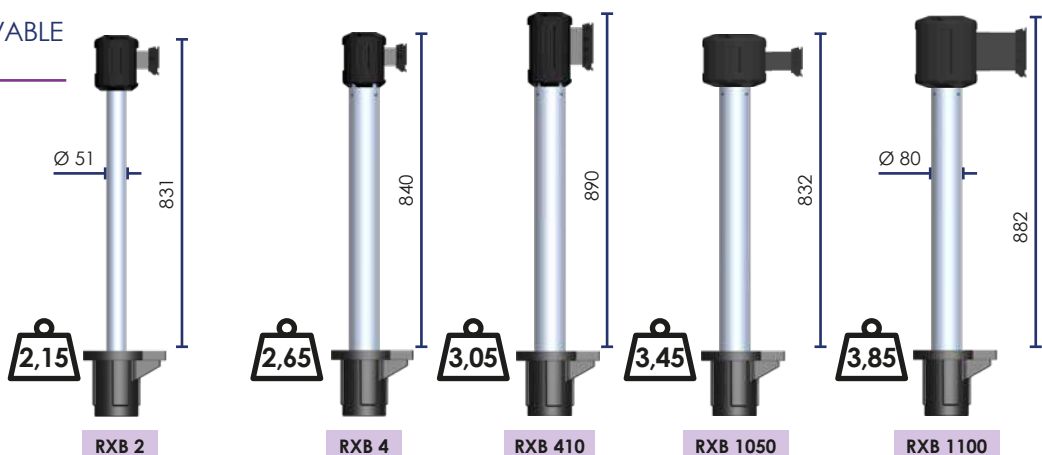

\* Poteau amovible o Removable post o Poste extraíble o Abnehmbarer Pfosten



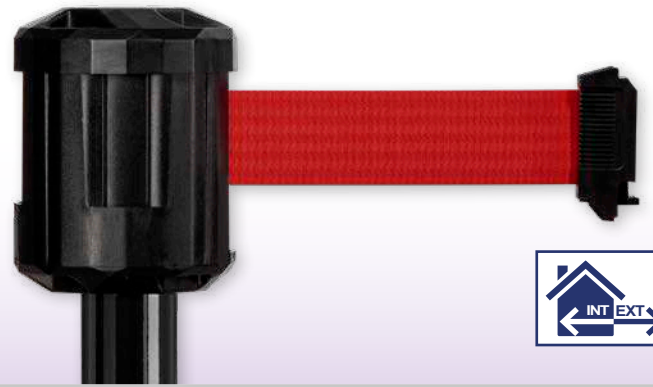

**ROULETTES** ◦ WHEELS  
 RUEDAS ◦ RUNDERFUSS

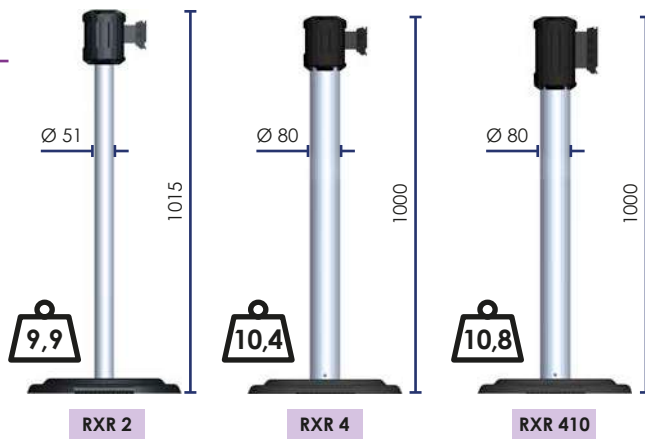

**HEAVY**



**À LESTER** ◦ TO BE LOADED  
 LASTRABLE ◦ BEFÜLBAR

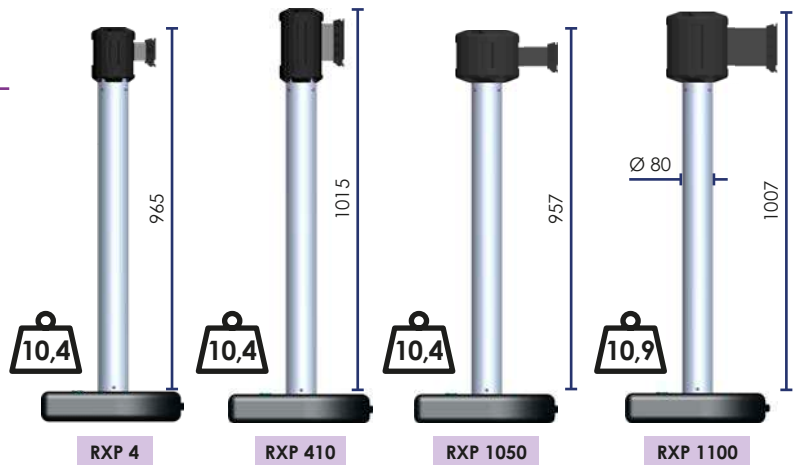



**RWX**

**ENROULEUR MURAL** o **WALL MOUNTED BARRIER**  
**ENROLLADOR MURAL DE CINTA** o **WANDAUFROLLER**



- Enrouleur mural à sangle pour limiter facilement l'accès à une zone
- Boîtier ABS étanche
- Sangle freinée
- Tête orientable
- Récepteur mural, kit aimanté et fixations inclus

- Wall-mounted retractable belt to easily limit access to an area
- Water-resistant ABS box
- Braked strap
- Adjustable head
- Wall receiver, magnets kit and fixings included

- Enrollador mural de cinta para limitar fácilmente el acceso a un área
- Caja ABS resistente al agua
- Cinta con freno
- Cabezal ajustable
- Receptor de pared, kit de imanes y fijaciones incluidos

- Durch den Wandaufroller kann der Zugang für bestimmte Bereiche eingeschränkt werden
- Wasserdichtes ABS-Gehäuse
- Absperrgurt mit Bremsvorrichtung
- Verstellbarer Kopf
- Einhängenvorrichtung, Magnetset und Befestigungen enthalten

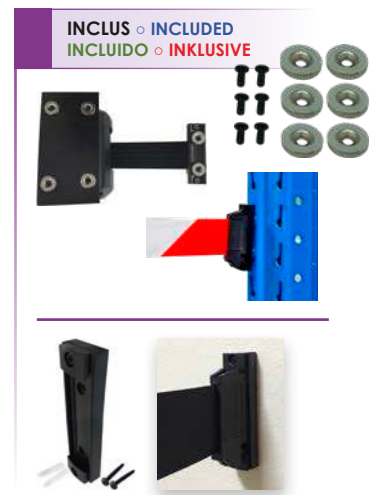
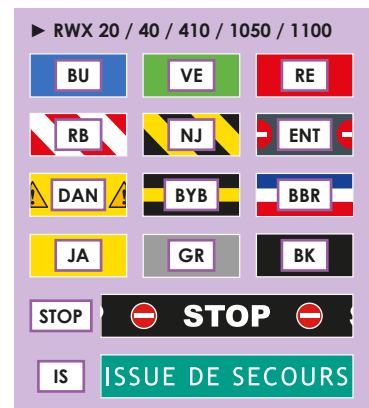
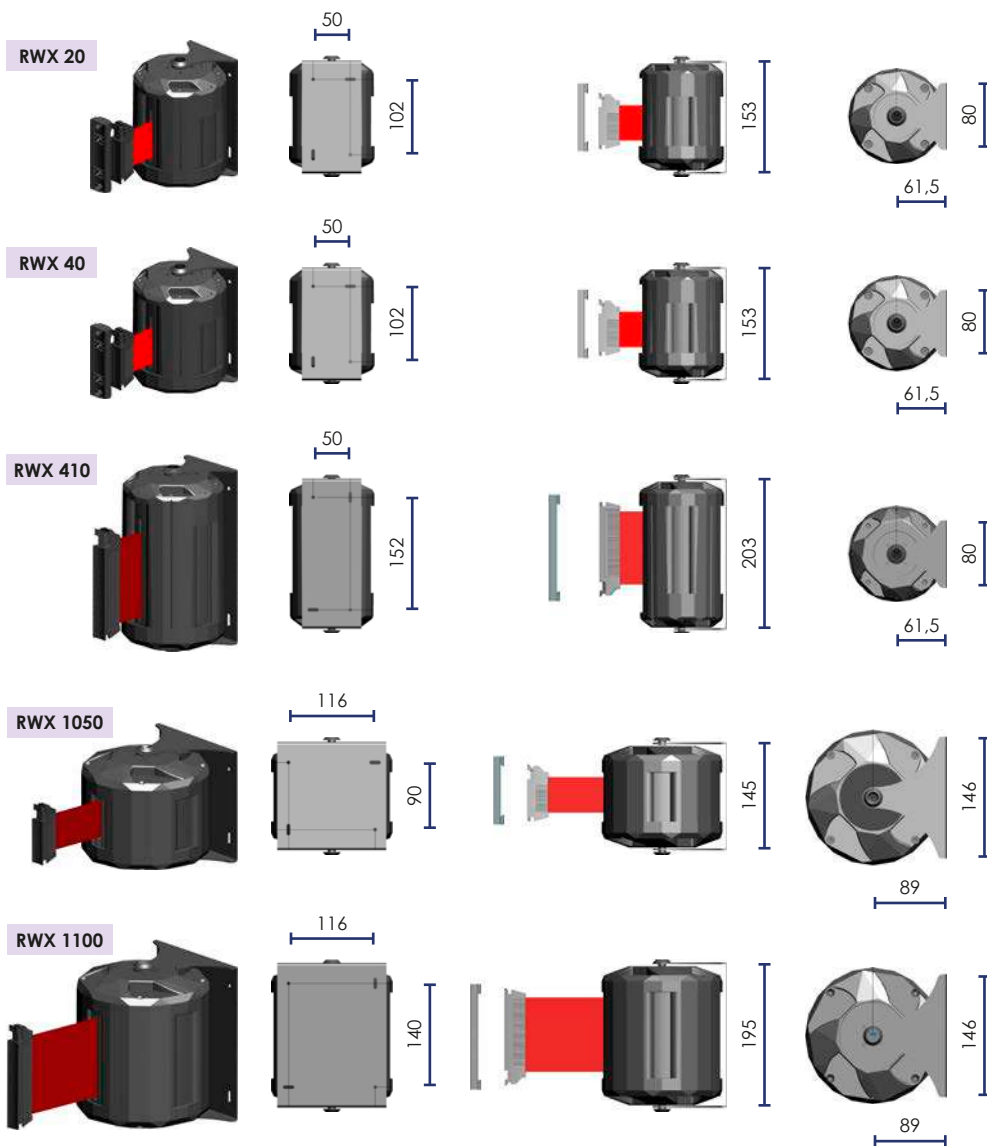





# POTEAUX D'INFORMATION

## INFORMATION POST ◦ POSTE DE INFORMACIÓN

### INFO STÄNDER



	Code	
	RS 160 BK	●
	RS 160 SR	●
	RSF 160 BK	●
	RSF 160 SR	●
	RSLO 160 BK	●
	RSLO 160 SR	●
	RSP 160 BK	●
	RSP 160 SR	●
	RSB 160 BK	●
	RSB 160 SR	●

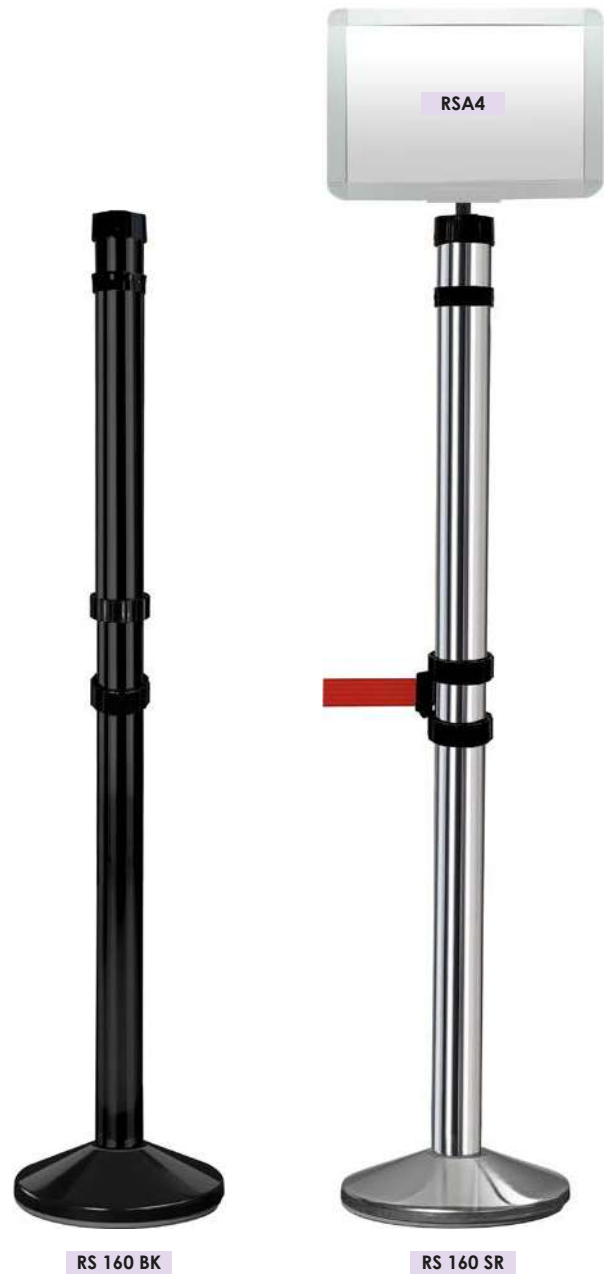
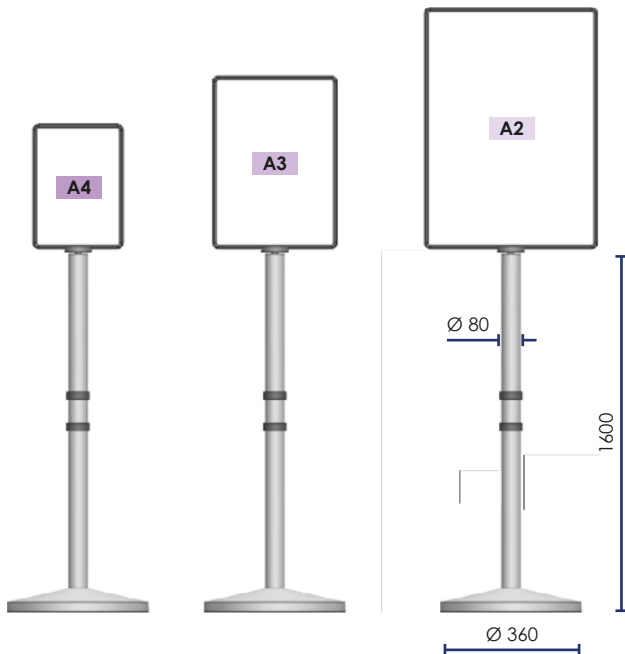
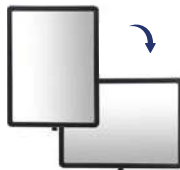

OPTION ◦ OPTIONAL ◦ OPCIÓN ◦ OPTIONAL ▶ p. 221



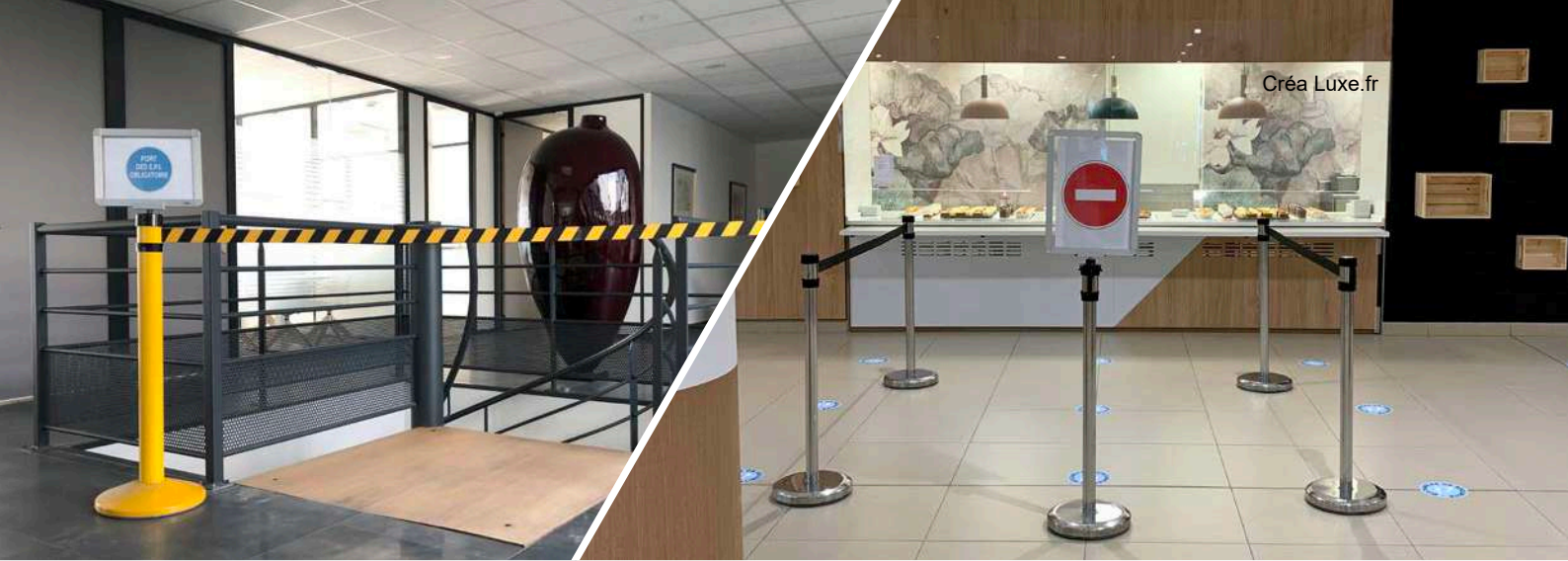

## ACCESSOIRES D'INFORMATION

SIGN HOLDERS ◦ PORTA CARTELES

ZUBEHÖR FÜR INFO STÄNDER



• La tête filetée de nos poteaux permet d'accrocher différents panneaux d'informations.

• The threaded head of our posts can be used to hold different information panels.

• La cabeza roscada de nuestros postes permite colocar distintos formatos de carteles.

• Die Gewindeaufnahme im Pfosten ermöglicht dieschnelle Aufnahme (Wechsel) von diversen Info-Tafel

Code		
RSA4 PN	●	0,54
RSA3 PN	●	0,98
RSA4 G	●	0,54
RSA3 G	●	0,98

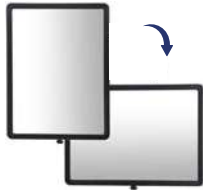

RSA4 PN



RSA3 PN



RSA4 G

Code		
RSA4	●	0,84
RSA3	●	1,15
RSA2	●	1,83



RSA4



RSA3

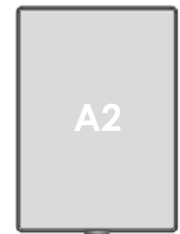

RSA2

Résistant à l'eau  
Water-resistant  
Resistente al agua  
Spritzwasser geschützt

Porte-affiche Aluminium orientable  
Aluminum sign holder multiposition  
Soporte ajustable de aluminio  
Verstellbarer Posterhalter aus Aluminium

Code		
RSA4 ROT	●	0,96
RSA3 ROT	●	1,39
RSA2 ROT	●	2,28



RSA4 ROT

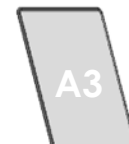

RSA3 ROT

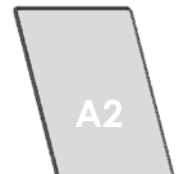

RSA2 ROT



- Affichage multi positions
- Utilisation intérieure et extérieure
- Multi-position display
- Indoor and outdoor use
- Porta-cartel multi-posición
- Uso en interior y en exterior
- Multipositionsanzeige
- Verwendung im Innen- und Außenbereich





## ACCESSOIRES ◦ ACCESSORIES ◦ ACCESORIOS ◦ ZUBEHÖR

### CONNECTEUR DE SANGLE ◦ BELT CONNECTOR CONECTOR DE CINTA ◦ GURTVERBINDER

Code	H Sangle Belt ◦ Cinta ◦ Gurt	
WRE CONNECT SB	50 mm	92 x 15
WRE 100 CONNECT	100 mm	144 x 15



### KIT FIXATION MAGNÉTIQUE ◦ MAGNETIC MOUNTING KIT KIT DE MONTAJE MAGNÉTICO ◦ HALTERUNGSATZ MIT MAGNET

- Kit composé de 6 aimants, livré avec la visserie : 2 aimants sont à poser sur l'attache murale et 4 sur le support mural de l'enrouleur.
- Kit including 6 magnets, delivered with fixings: 2 magnets are to be placed on the wall receiver and 4 on the belt frame.

- Kit compuesto de 6 imanes, suministrado con fijaciones: 2 imanes para colocar en el receptor de pared y 4 en el marco de la cinta.
- Satz besteht aus 6 Magneten inkl. Schrauben, 2 Magnete f. Wandhalterung / 4 Magnete f. Aufroller

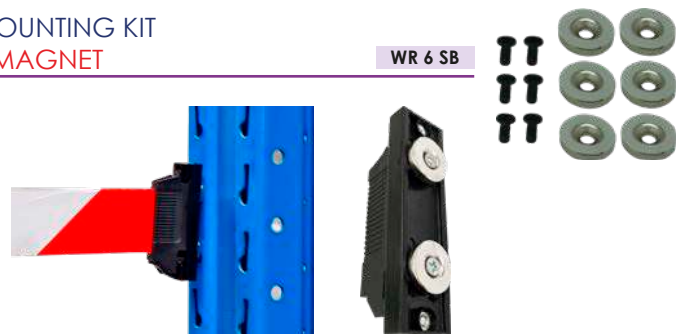

### RÉCEPTEUR MURAL DE SANGLE ◦ BELT WALL RECEIVER RECEPTOR MURAL DE CINTA ◦ WANDHALTERUNG

Code	H Sangle Belt ◦ Cinta ◦ Gurt	
WRE SB	50 mm	92 x 15
WRE 100 SB	100 mm	144 x 15



### ADAPTATEUR UNIVERSEL UNIVERSAL ADAPTER ADAPTADOR UNIVERSAL UNIVERSAL ADAPTER

Code	H Sangle Belt ◦ Cinta ◦ Gurt
WRAD SB	50 mm



- Permet un raccordement avec les poteaux d'autres marques. Nous consulter.
- Allows connection with posts of other brands. Contact us.
- Permite la conexión con postes de otras marcas. Consultarnos.
- Ermöglicht die Verbindung mit Pfosten von anderer Fabriken. Wir bitten Rücksprache.

### FIXATION AUTOUR D'UN POTEAU FIXATION AROUND A POST FIJACIÓN ALREDEDOR DE UN POSTE BEFESTIGUNG UM EINEN PFOSTEN

Code	H Sangle Belt ◦ Cinta ◦ Gurt
WR 10 SB	50 mm





## TROLLEY 6 / 9

### CHARIOT TRANSPORT POTEAU ○ POST TROLLEY CARRO DE TRANSPORTE PARA POSTES ○ TRANSPORTWAGEN F. PFOSTEN

Code	kg
TROLLEY 9	50
TROLLEY 9 EXT	47
TROLLEY 6	38
TROLLEY 6 EXT	35

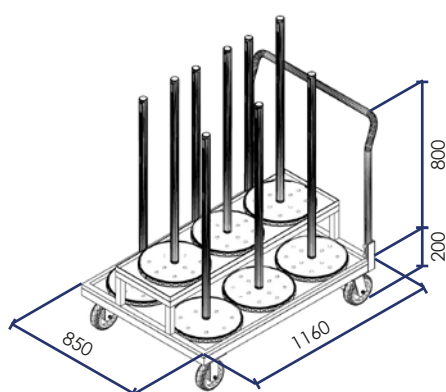

TROLLEY 9 EXT

TROLLEY 9 EXT

TROLLEY 9

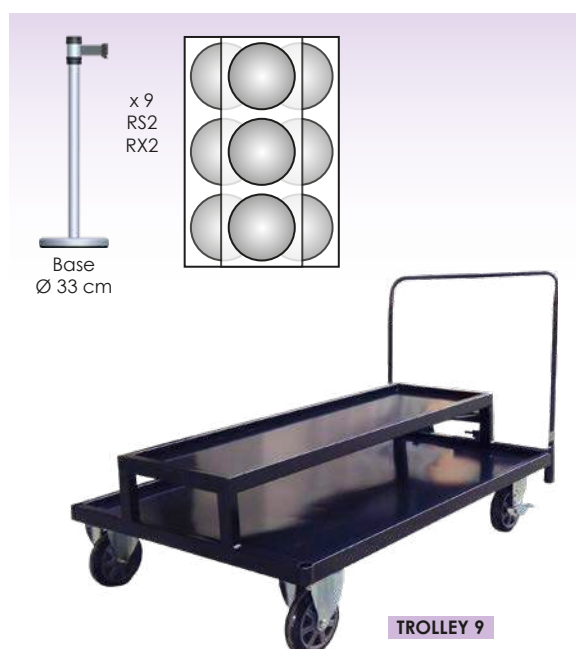

TROLLEY 9

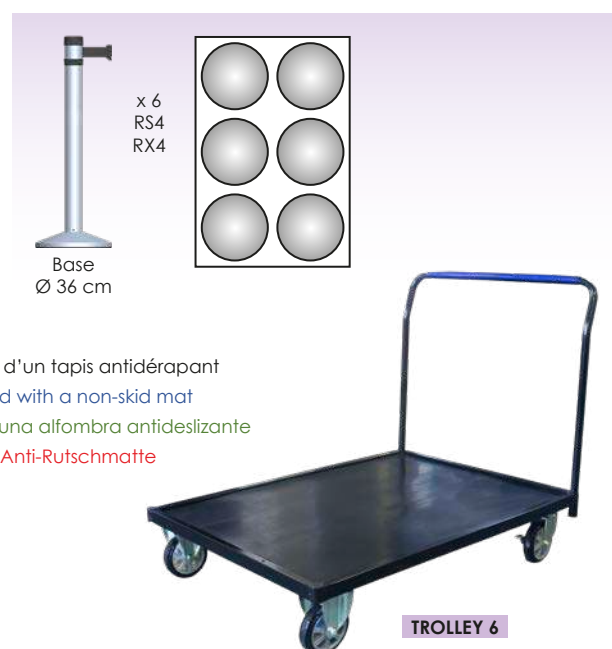

TROLLEY 6



x 9  
RS2  
RX2

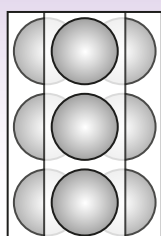

x 6  
RS4  
RX4

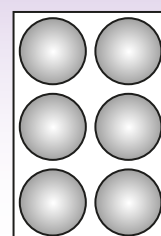

- Recouvert d'un tapis antidérapant
- Covered with a non-skid mat
- Cubierto con una alfombra antideslizante
- Mit Anti-Rutschmatte



2 roues pivotantes avec frein  
2 swivel wheels with brakes  
2 ruedas giratorias con freno  
2 Schwenkräder mit Bremse



2 roues fixes  
2 fixed wheels  
2 ruedas fijas  
2 Räder fest



Capuchons cache trous  
Caps for hiding holes  
Tapones ciegos  
Abdeckkappen



Liaison chariot  
Trolley link  
Enlace para carros  
Anhänger Vorrichtung



Poignée ergonomique  
Ergonomic handle  
Mango ergonómico  
Ergonomische Griffe





A series of horizontal lines for writing, starting from the top line and extending down to the bottom of the page.









# RECO / REDO

## POTEAU DE GUIDAGE À SANGLE ○ RETRACTABLE BELT STANCHION POSTE CON CINTA ○ PERSONNENLEITSYSTEM



- Permet d'interdire facilement l'entrée d'une zone, délimiter des accès ou guider les personnes dans la file d'attente.
- Sangle de 3 m, largeur 50 mm.
- Usage recommandé en intérieur. Occasionnel en extérieur mais pas sous la pluie.
- In order to easily forbid the access of an area.
- 3 m belt, width 50 mm.
- Indoor use recommended. Outdoor use occasionally but not under the rain.
- Permite prohibir la entrada a una zona, delimitar los accesos o guiar a las personas en la cola.
- 3 m de correa, anchura 50 mm.
- Recomendado para uso en interiores. Uso ocasional en el exterior pero no en la lluvia.
- Einfache Regelung der Zugangsbereiche.
- Gurtlänge 3 m, Breite 50 mm.
- Empfohlen f. Innenbereich. Gelegentliche Außenbenutzung möglich, jedoch nicht regentauglich.

	RECO 2 BK BK	RECO 2 SR BK	RECO 2 LA BK
	RECO 2 BK RE	RECO 2 SR RE	RECO 2 LA RE
	RECO 2 BK BU	RECO 2 SR BU	RECO 2 LA BU
	RECO 2 BK JA	RECO 2 SR JA	RECO 2 LA JA
	RECO 2 BK NJ	RECO 2 SR NJ	RECO 2 LA NJ
	RECO 2 BK RB	RECO 2 SR RB	RECO 2 LA RB

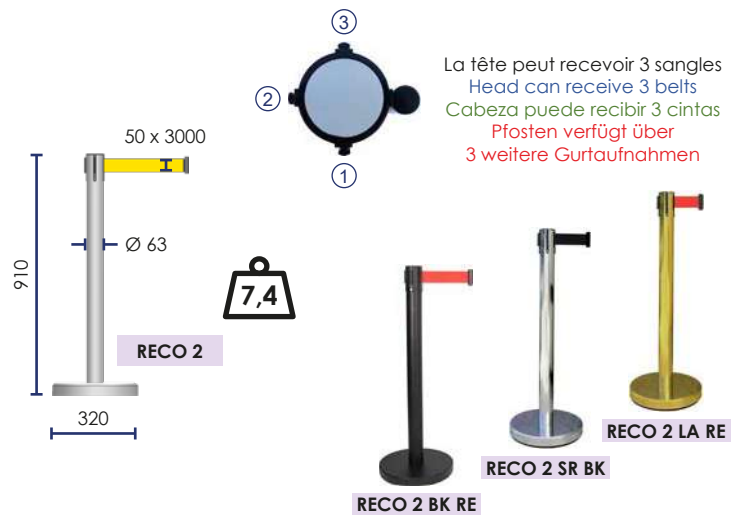

	RECO 22 BK BK	RECO 22 SR BK	RECO 22 LA BK
	RECO 22 BK RE	RECO 22 SR RE	RECO 22 LA RE
	RECO 22 BK BU	RECO 22 SR BU	RECO 22 LA BU
	RECO 22 BK JA	RECO 22 SR JA	RECO 22 LA JA
	RECO 22 BK NJ	RECO 22 SR NJ	RECO 22 LA NJ
	RECO 22 BK RB	RECO 22 SR RB	RECO 22 LA RB



	REDO 4 BK BK	REDO 4 SR RE	REDO 4 NJ NJ	REDO 4 RB RB

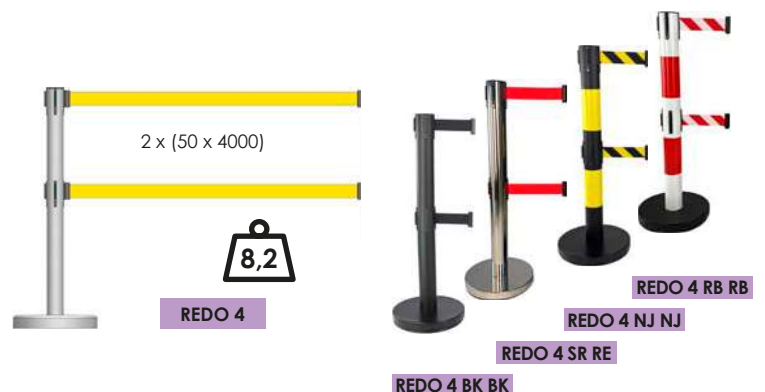

## REWO 20

## ENROULEUR MURAL ◦ WALL MOUNTED RECEIVER

### ENROLLADOR MURAL DE CINTA ◦ WANDKASSETTE



- Permet d'interdire facilement l'entrée d'une zone, délimiter des accès.
- Sangle 3 m, largeur 50 mm.
- Récepteur mural inclus.
- Fixations incluses.

- In order to easily forbid the access of an area.
- Strap 3 m, width 50 mm.
- Wall-mounted receiver included.
- Fixations included.

- Facilita prohibir la entrada a una zona, delimitar los accesos o guiar a las personas en la cola.
- Correa de 3 m, anchura 50 mm.
- Incluye un receptor de pared.
- Se incluyen soportes de montaje.

- Einfaches absperrn des Zugangs zu einem Bereich.
- Bandlänge 3 m, Breite 50 mm.
- Wandclip im Lieferumfang enthalten.
- Inkl. Befestigungsmaterial.

Code	
REWO 20 BK	
REWO 20 RE	
REWO 20 BU	
REWO 20 JA	
REWO 20 NJ	
REWO 20 RB	



REWO 20 BK

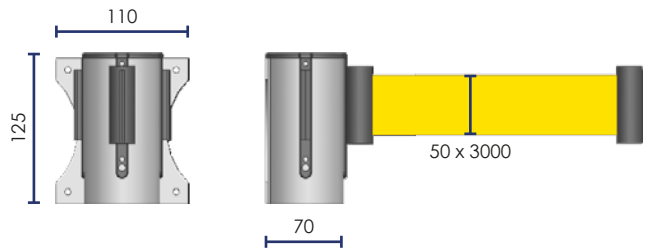

INCLUS ◦ INCLUDED ◦ INCLUIDO ◦ INKLUSIVE



Accroche murale  
Wall-mounted receiver  
Receptor de pared  
Wandbefestigungsplatte

WR 24 SB

## ACCESSOIRES ◦ ACCESSORIES ◦ ACCESORIOS ◦ ZUBEHÖR

### KIT FIXATION MAGNÉTIQUE ◦ MAGNETIC MOUNTING KIT

#### KIT DE MONTAJE MAGNÉTICO ◦ BEFESTIGUNGSSET MAGNETISCH

- Kit composé de 6 aimants, livré avec la visserie : 2 aimants sont à poser sur l'attache murale et 4 sur le support mural de l'enrouleur.
- Kit including 6 magnets, delivered with fixings: 2 magnets are to be placed on the wall receiver and 4 on the belt frame.
- Kit compuesto de 6 imanes, suministrado con fijaciones: 2 imanes para colocar en el receptor de pared y 4 en el marco de la cinta.
- Satz besteht aus 6 Magneten inkl. Schrauben, 2 Magnete f. Wandhalterung / 4 Magnete f. Aufroller



WR 6 SB

### PORTE AFFICHE ◦ SIGN HOLDER

#### PORTA AFICHE ◦ INFORMATIONSTAFEL



RECO A4P BK

Code		
RECO A4P BK		ABS
RECO A3P BK		ABS
RECO A4P GO		ABS
RECO A3P GO		ABS
RECO A4P CH		alu
RECO A3P CH		alu

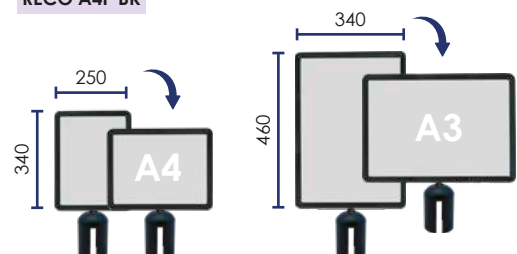

### ACCROCHE MURALE

#### WALL-MOUNTED RECEIVER

#### RECEPTOR DE PARED

#### WANDBEFESTIGUNGSPLATTE



WR 24 SB

En option pour les poteaux à sangle  
Optional with retractable belt stanchion  
Opcional con el poste con cinta  
Optional für Gurtpfosten





A series of horizontal lines for writing notes, starting from the top line below the pencil icon and extending down to the bottom of the page.







SMART

## POTEAU DE GUIDAGE À SANGLE

### RETRACTABLE BELT STANCHION ◦ POSTE CON CINTA

### PERSONNENLEITSYSTEM



- Usage recommandé en intérieur. Occasionnel en extérieur mais pas sous la pluie.
- Indoor use recommended. Outdoor use occasionally but not under the rain.
- Recomendado para uso en interiores. Uso ocasional en el exterior pero no en la lluvia.
- Empfohlen f. Innenbereich. Gelegentliche Außenbenutzung möglich, jedoch nicht regentauglich.
- Sangle de 2 m, largeur 30 mm.
- 2 m belt, width 30 mm.
- 2 m de cinta, ancho 30 mm.
- Gurtlänge 2m, Breite 30 mm.

	SMART 55 BK BK	SMART 55 SR BK
	SMART 55 BK RE	SMART 55 SR RE
	SMART 85 BK BK	SMART 85 SR BK
	SMART 85 BK RE	SMART 85 SR RE

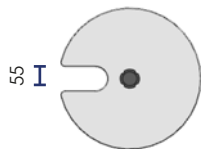

	RWSMART BK
	RWSMART RE



OPTION ◦ OPTIONAL ◦ OPCIÓN ◦ OPTIONAL

Code	
SMART A4 PN	
SMART A3 PN	
SMART A4	
SMART A3	



Adaptateur  
Connector  
Adaptador  
Adapter

INCLUS ◦ INCLUDED  
INCLUIDO ◦ INKLUSIVE



Base lestée + patin de protection  
Weighted base with foam  
Base pesada con protecciones  
Basisplatte + Schutzpolster



## POTEAU DE DÉLIMITATION POUR CORDE ÉLASTIQUE

GUIDING POST WITH ELASTIC CORD ◦ POSTE CON CUERDA ELÁSTICA

BEGRENZUNGSPFOSTEN FÜR ELASTISCHES SEIL



- Usage recommandé en intérieur.  
Occasionnel en extérieur mais pas sous la pluie.
- Indoor use recommended.  
Outdoor use occasionally but not under the rain.

- Recomendado para uso en interiores.  
Uso ocasional en el exterior pero no en la lluvia.
- Empfohlen f. Innenbereich. Gelegentliche  
Außenbenutzung möglich, jedoch nicht regentauglich.

Code	
RMU 500	
RMU 850	
RMU 500 BK	
RMU 850 BK	

RMU 850



RMU 850 BK

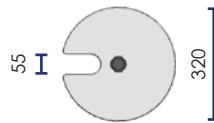

RMU 850

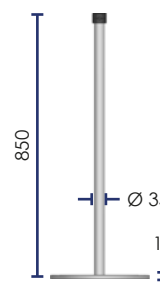

RMU 500

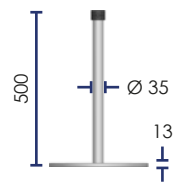

## CORDE ÉLASTIQUE ◦ ELASTIC CORD ◦ CUERDA ELÁSTICA ◦ GUMMIBAND



Ø 4MM X 20 M

SL 420 SB



Ø 6MM X 20 M

SL 620 SB

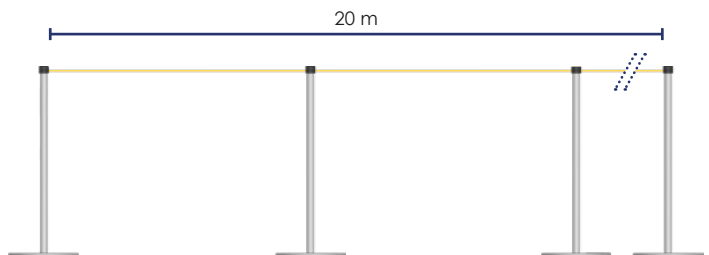

OPTION ◦ OPTIONAL ◦ OPCIÓN ◦ OPTIONAL

Code		
RMU A4 PN		
RMU A3 PN		
RMU A4 ALU		
RMU A3 ALU		



INCLUS ◦ INCLUDED  
INCLUIDO ◦ INKLUSIVE



Base lestée + patin de protection  
Weighted base with foam  
Base pesada con protecciones  
Basisplatte + Schutzpolster





## POTEAU DE DÉLIMITATION POUR CORDE ET CHAÎNE

GUIDING POST WITH CHAIN OR ROPE ◦ POSTE CON CUERDA O CADENA  
PFOSTEN (PERSONENLEITSYSTEM) FÜR SEIL ODER KETTE



Code	
SMART 55 SR	
SMART 85 SR	
SMART 55 BK	
SMART 85 BK	



- Usage recommandé en intérieur. Occasionnel en extérieur mais pas sous la pluie.
- Indoor use recommended. Outdoor use occasionally but not under the rain.
- Recomendado para uso en interiores. Uso ocasional en el exterior pero no en la lluvia.
- Empfohlen f. Innenbereich. Gelegentliche Außenbenutzung möglich, jedoch nicht regentauglich.

## CORDE TRESSÉE ◦ BRAIDED ROPE

CUERDA TRENZADA ◦ KORDEL GEFLOCHTEN

Code		
CI 2 C		
CI 2 G		
CI 2 BLE N		
CI 2 BLE		
CI 2 RN		
CI 2 R		
CI 2 NN		
CI 2 N		
CI 2 BBR N		
CI 2 BBR		



## CORDE VELOURS ◦ VELVET ROPE

CUERDA DE TERCIPELO ◦ SAMT / VELOURSKORDEL

Code		
REZO 150 BK SR		
REZO 150 BK LA		
REZO 150 RE SR		
REZO 150 RE LA		



## CHAÎNE ACIER ◦ STEEL CHAIN ◦ CADENA DE ACERO ◦ STAHLKETTEN

Code	
CDCH 252 SB	
CDN 252 SB	

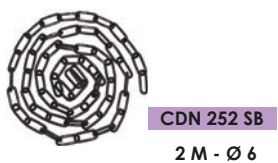
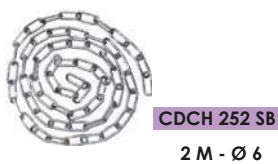

INCLUS ◦ INCLUDED ◦ INCLUIDO ◦ INKLUSIVE



Autres couleurs ► p. 188 ◦ Other color ► p. 188 ◦ Otros colores ► p. 188 ◦ Andere Farben ► p. 188





PRINTEMPS  
MODE

PRINTEMPS





REXO 100

**POTEAU DE GUIDAGE POUR CORDE OU CHÂÎNE**  
**GUIDING POST WITH CHAIN OR ROPE** ◦ **POSTE CON CUERDA O CADENA**  
**PPOSTEN (PERSONENLEITSYSTEM) FÜR SEIL ODER KETTE**



- Usage recommandé en intérieur.  
Occasionnel en extérieur mais pas sous la pluie.
- Indoor use recommended.  
Outdoor use occasionally but not under the rain.

- Recomendado para uso en interiores.  
Uso ocasional en el exterior pero no en la lluvia.
- Empfohlen f. Innenbereich. Gelegentliche  
Außenbenutzung möglich, jedoch nicht regentauglich.



Code	
REXO 100 CHC	
REXO 100 BKC	
REXO 100 LAC	



REXO 100 BKC



REXO 100 CHC



REXO 100 LAC

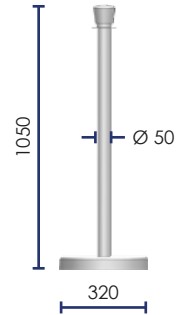

Code	
REXO 100 CHR	
REXO 100 BKR	
REXO 100 LAR	



REXO 100 BKR



REXO 100 CHR



REXO 100 LAR

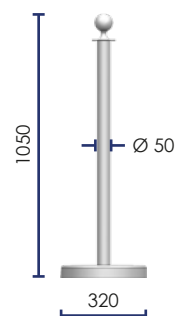

**PORTE AFFICHE** ◦ **SIGN HOLDER**  
**PORTA AFICHE** ◦ **INFORMATIONSTAFEL**



Code		
REXO 4 PN		ABS
REXO 3 PN		ABS
REXO 4 ALU		alu
REXO 3 ALU		alu
REXO 4 G		ABS
REXO 3 G		ABS

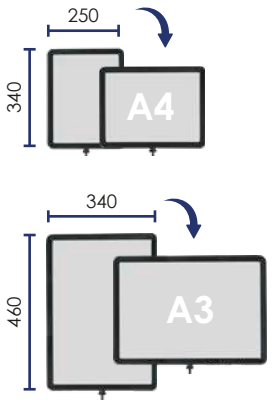



REXO 2 / 22

# POTEAUX DE GUIDAGE À CORDE

## GUIDING POST WITH ROPE

### POSTE CON CUERDA

### KORDELSTÄNDER



- Usage recommandé en intérieur.  
Occasionnel en extérieur mais pas sous la pluie.
- Indoor use recommended.  
Outdoor use occasionally but not under the rain.

- Recomendado para uso en interiores.  
Uso ocasional en el exterior pero no en la lluvia.
- Empfohlen f. Innenbereich. Gelegentliche  
Außenbenutzung möglich, jedoch nicht regentauglich.



Corde velours  
Velvet rope  
Cuerda de terciopelo  
Samt / Velourskordel

1,60 M - Ø 30



REXO 22 LAI BK



REXO 22 SR BK



REXO 22 BK RE

	REXO 22 BK BK	REXO 22 SR BK	REXO 22 LAI BK
	REXO 22 BK RE	REXO 22 SR RE	REXO 22 LAI RE

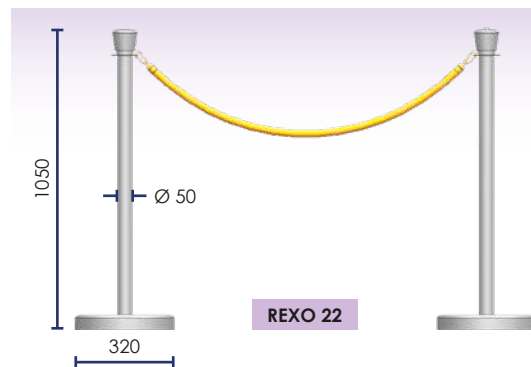

REXO 22

	REXO 2 BK BK	REXO 2 SR BK	REXO 2 LAI BK
	REXO 2 BK RE	REXO 2 SR RE	REXO 2 LAI RE

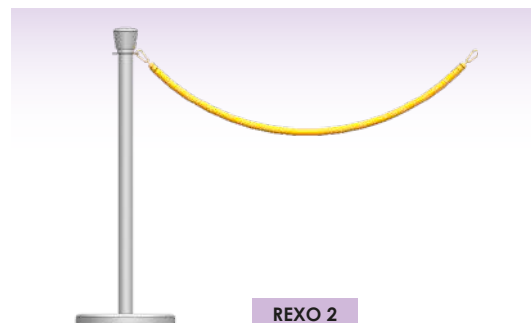

REXO 2





## CORDE TRESSÉE

BRAIDED ROPE ◦ CUERDA TRENZADA ◦ KORDEL GEFLOCHTEN



Code		
CI 2 BLE L		
CI 2 BLE		
CI 2 G		
CI 2 R L		
CI 2 R		
CI 2 N L		
CI 2 N		
CI 2 BBR L		
CI 2 BBR		



CI 2 BLE

2 M - Ø 30



CI 2 BBR



## CORDE VELOURS

VELVET ROPE ◦ CUERDA DE TERCIOPELO ◦ KORDEL MIT SAMT

Code		
REZO 150 BK SR		
REZO 150 BK LA		
REZO 150 RE SR		
REZO 150 RE LA		



1,60 M - Ø 30

REZO 150 RE LA



REZO 150 BK SR



## CORDE TORSADES

TWISTED ROPE ◦ CUERDA TORCIDA ◦ FLECHTSEIL

Code	
CI 2 C L	
CI 2 C	



CI 2 C



## ACCROCHE MURALE

WALL RECEIVER ◦ RECEPTOR DE PARED ◦ WANDHALTERUNG

Code	
ATC 01 SB	
ATL 01 SB	

ATC 01 SB



ATL 01 SB





## REXO 60

### POTEAU POUR CORDE FILANTE

POST FOR ROPE ◦ POSTE PARA CUERDA

STÄNDER FÜR KORDEL



REXO 60 BK



REXO 60 CH



REXO 60 LA

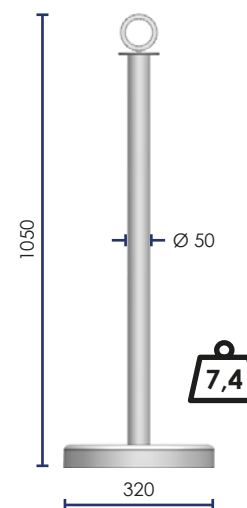

### CORDE 10 M

ROPE ◦ CUERDA ◦ SEIL

Code	
REZO 100 RED	
REZO 100 BLACK	
REZO 100 ECRU	

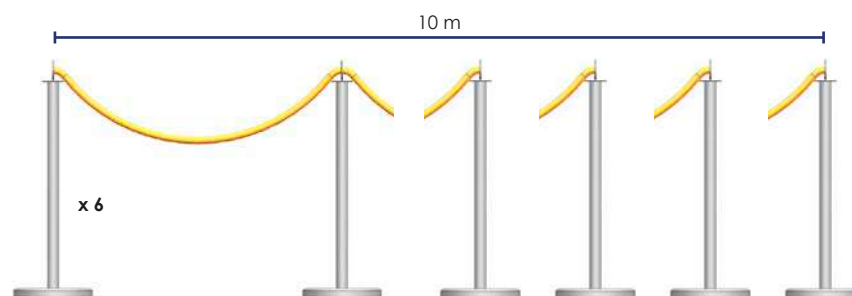

10 M - Ø 32



10 M - Ø 32



10 M - Ø 32





# REXO CHAIN

## POTEAUX DE GUIDAGE AVEC CHAÎNE

GUIDING POSTS WITH CHAIN ◦ POSTES CON CADENA

ABSPERRPFOSTEN MIT KETTE



REXO CHAIN 2 CH	REXO CHAIN 2 BK	REXO CHAIN 2 LA	
REXO CHAIN 1 CH	REXO CHAIN 1 BK	REXO CHAIN 1 LA	

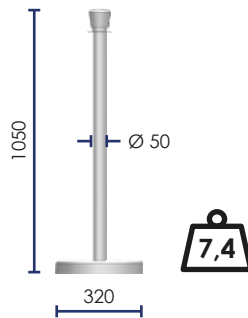
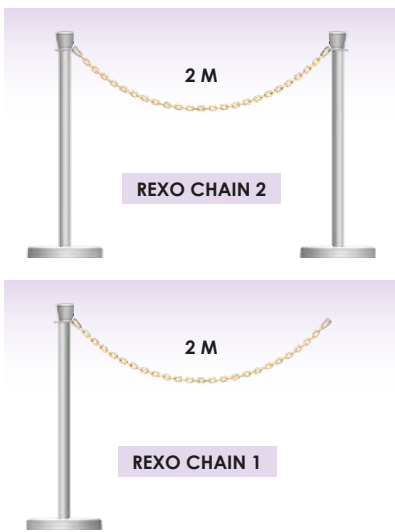

## ACCESSOIRES ◦ ACCESSORIES ◦ ACCESORIOS ◦ ZUBEHÖR

CDCH 252 SB  
2 M - Ø 6



CDN 252 SB  
2 M - Ø 6



CDGO 252 SB  
2 M - Ø 6



► p. 234



## REXO BACH

### KIT POTEAUX AVEC BÂCHE PERSONNALISÉE POSTS AND CUSTOMIZED TARPULIN ◦ POSTES CON LONA PERSONALIZADA STÄNDER SATZ MIT KUNDENINDIVIDUELLEN PLANE



- Bâche avec fourreau - traitée anti UV
- Tarpaulin with scabbard - UV resistant
- Lona con funda - Resistente a los UV
- Plane mit Aufbewahrungsfutteral - UV beständig

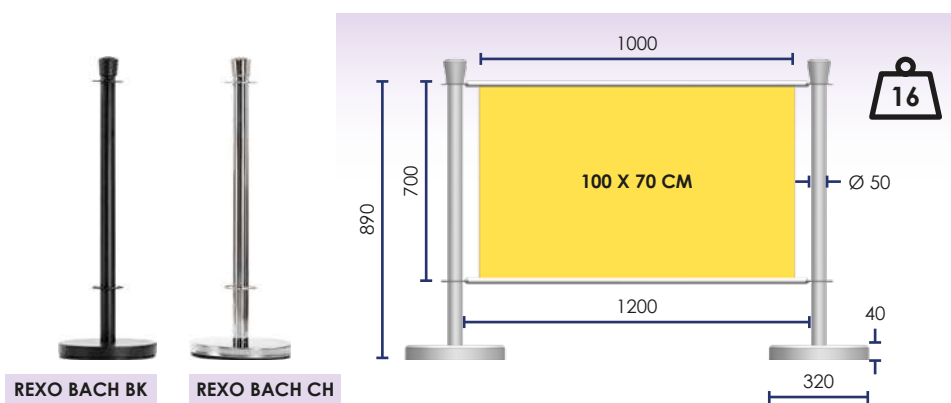

REXO BACH 2 BK



REXO BACH 1 BK



REXO BACH 2 CH



REXO BACH 1 CH

#### OPTION ◦ OPTIONAL ◦ OPCIÓN ◦ OPTIONAL



Code	
REXO 4 PN	
REXO 3 PN	
REXO 4 ALU	
REXO 3 ALU	

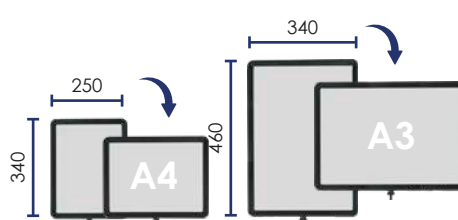

Bâche brise vent microperforée  
Microperforation wind break tarpaulin  
Lona cortavientos microperforada  
Mikroperforierte Windschutzhülle







## KIT POTEAUX AVEC PANNEAU PERSONNALISÉ

POSTS AND CUSTOMIZED PANEL ◦ POSTES CON PANEL PERSONALIZADO  
PFOSTEN SATZ MIT INDIVIDUELLEN KUNDEN PANEL

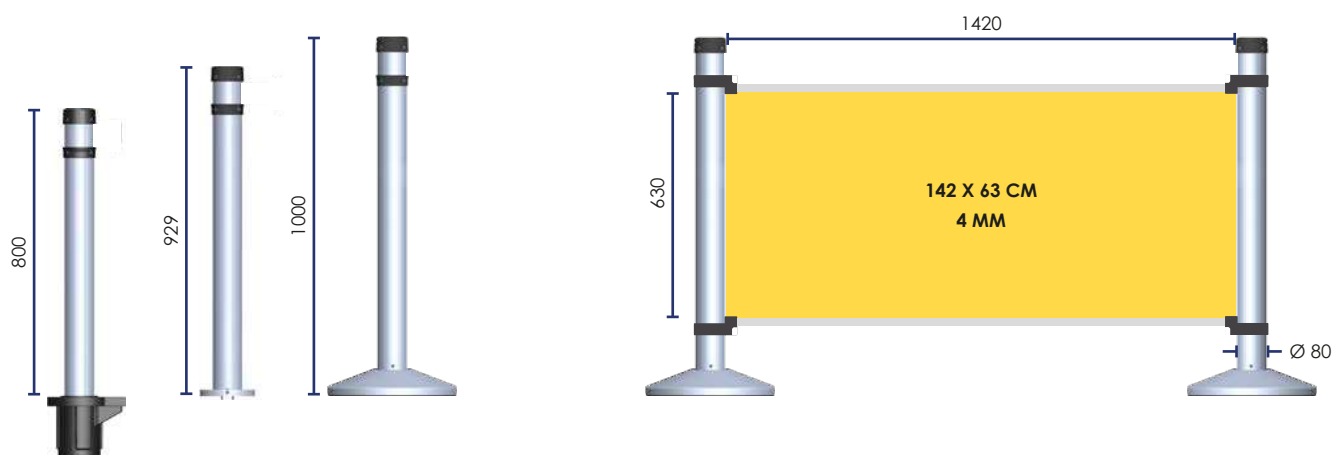

Type base ► p. 212 - 213  
Base type  
Tipo base  
Bodenhülse



RS 4 RING

Bagues de fixations  
Fixations rings  
Anillo de fijación  
Befestigungsring



RS 4 BAR

Rails pour panneau  
Panel rails  
Rieles para panel  
Führungsschiene für Panel



RS 4 PNX

142 x 63 cm / 4 mm

Panneau personnalisé  
Customized panel  
Panel personalizado  
Individueller Kunden Panel

## COULEUR POTEAU ◦ POST COLOR

COLOR POSTE ◦ PFOSTEN FARBVARIANTEN



OPTION ◦ OPTIONAL ◦ OPCIÓN ◦ OPTIONAL ► p. 221







# BAR- KIT



## KIT POTEAUX AVEC BARRIÈRES ○ POSTS WITH BARRIERS POSTES CON BARRERAS ○ SET Absperrung mit Latten

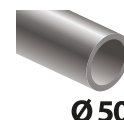

Code		
BAR-CH KIT		19
BAR-BK KIT		
BAR-CH EXT		9,5
BAR-BK EXT		

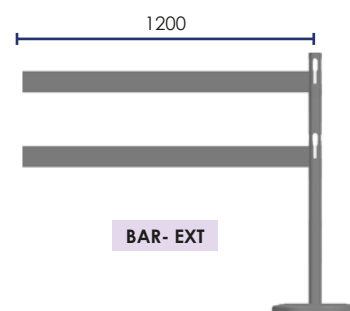
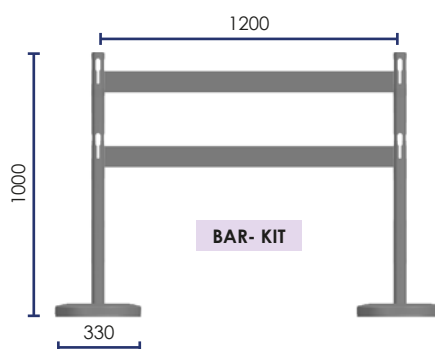

Code		
BSA 100 AISI		8
BSA 100 N		

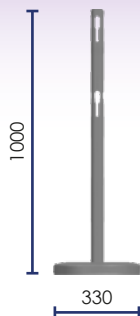

Code		
BSA 1202 ZG		2,7
BSA 1202 N		

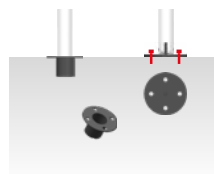
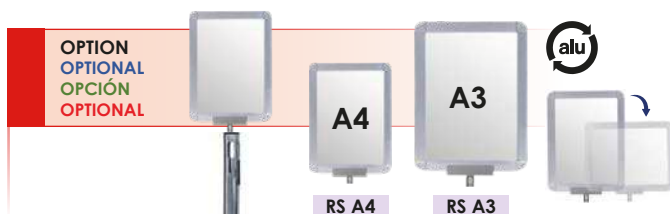
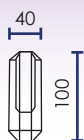

Fixation dans le sol ► p. 183  
Ground fixing ► p. 183  
Fijación al suelo ► p. 183  
Boden Befestigung ► p. 183

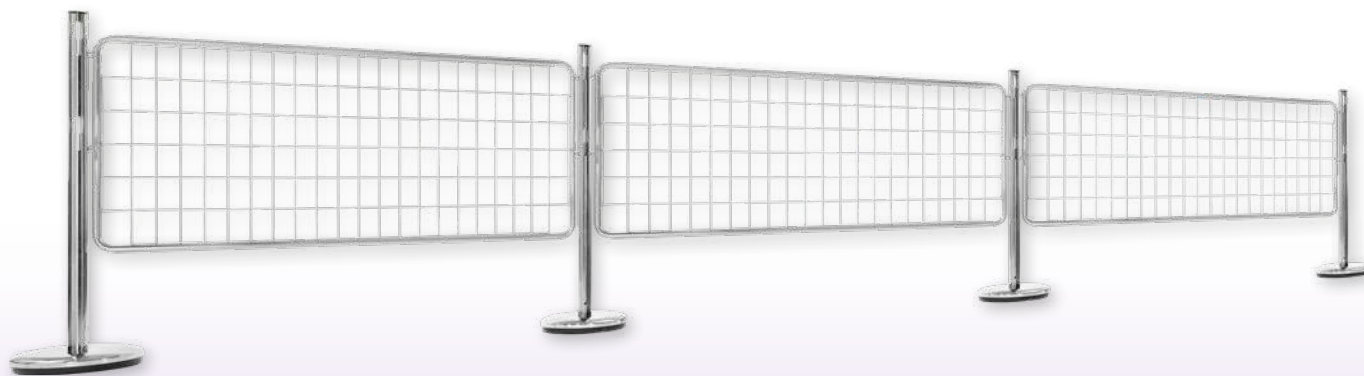

# GRI KIT

## KIT POTEAUX AVEC GRILLE

POSTS WITH FENCE  
POSTES CON REJA ○ SET ABSPERRUNG MIT GITTER

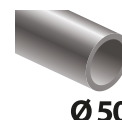

Code	
GRI CH KIT	
GRI BK KIT	
GRI CH EXT	
GRI BK EXT	

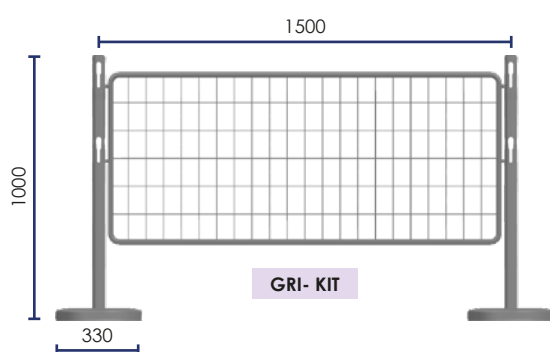

GRI- KIT

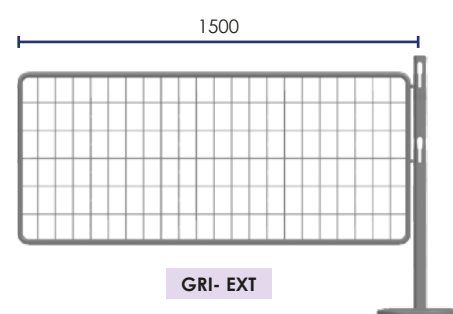

GRI- EXT

Code	
BSA 100 AISI	
BSA 100 N	

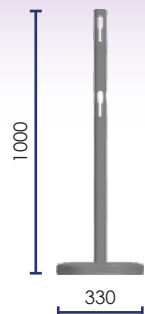

BSA 100 AISI

BSA 100 N



Code	
B 1500 ZG	
B 1500 N	

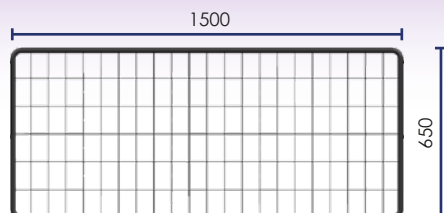

B1500



OPTION  
OPTIONAL  
OPCIÓN  
OPTIONAL

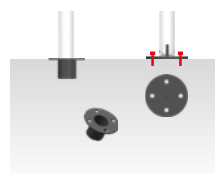
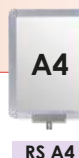

Fixation dans le sol ▶ p. 183  
Ground fixing ▶ p. 183  
Fijación al suelo ▶ p. 183  
Boden Befestigung ▶ p. 183





# KIT DE GUIDAGE PLASTIQUE

## PLASTIC GUIDING KIT ◦ KIT DE GUIADO DE PLÁSTICO

### ABSPERRUNGSSET AUS KUNSTSTOFF

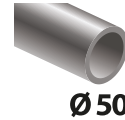

Code		
CBR SET N	●	●
CBR SET B	○	○
CBR SET G	●	●
CBR EXT N	●	●
CBR EXT B	○	○
CBR EXT G	●	●

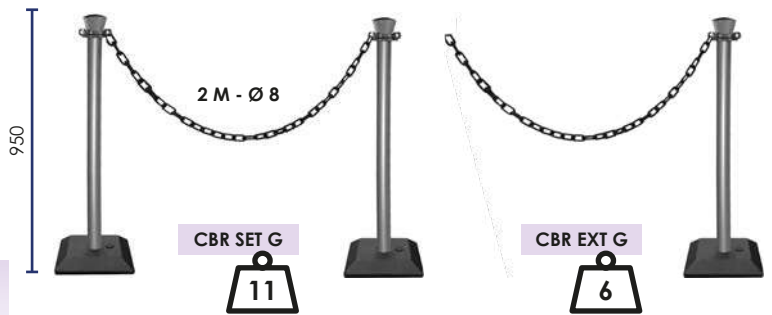

Code		
PPC 1 NN KIT	●	●
PPC 1 BR KIT	○	●
PPC 1 GG KIT	●	●
PPC 1 NN EXT	●	●
PPC 1 BR EXT	○	●
PPC 1 GG EXT	●	●

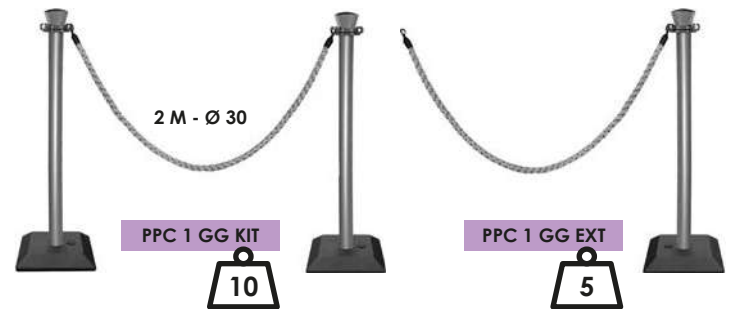

EXISTE AUSSI EN VERSION ◦ ALSO EXISTS IN VERSION  
TAMBIÉN EXISTE EN VERSIÓN ◦ LIEFERBAR IN AUSFÜHRUNGEN

Pliant ▶ p. 173  
Foldable  
Plegable  
Zusammenlegenbar

Base lourde ▶ p. 172  
Heavy base  
Base pesada  
Stanfuss

A planter ▶ p. 172  
With stake  
Con estaca  
Bodenbefestigung



OPTION  
OPTIONAL  
OPCIÓN  
OPTIONAL

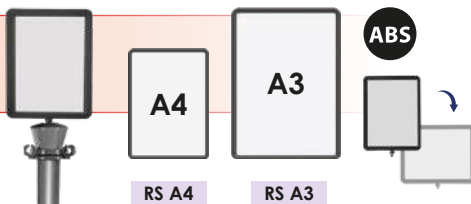

APF 801 N SB	●
APF 801 B SB	○



APO 801 N SB	●
APO 801 B SB	○





INFORMATION  
SORTIE  
MUSEE DE LYONNE







## POTEAU D'INFORMATION - HAUTEUR AJUSTABLE

INFORMATION POST - ADJUSTABLE HEIGHT

POSTE DE INFORMACIÓN - ALTURA AJUSTABLE

INFO-PFOSTEN HÖHENVERSTALLBAR



Code		
SWP 4	A4	8
SWP 3	A3	9
SWP 2	A2	10



SWP 2



SWP 3

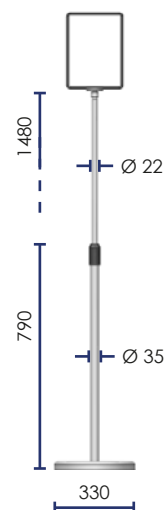

SWP 4



Portrait ou paysage  
Portrait or landscape  
Retrato o paisaje  
Hoch- oder Querformat



SWP 2



SWP 3



SWP 4



SWP ROT

## POTEAUX D'INFORMATION - POSITION ET HAUTEUR RÉGLABLES

INFORMATION POST - ADJUSTABLE POSITION AND HEIGHT

POSTE DE INFORMACIÓN - POSICIÓN Y ALTURA AJUSTABLES

INFO-POSTEN - INFOTAFEL VERSTELLBAR (IN 2 RICHTUNGEN)



Code		
SWP 4 ROT	A4	9
SWP 3 ROT*	A3	10,5
SWP 2 ROT	A2	12



Rotule permettant d'orienter ou d'incliner le panneau dans toutes les positions.  
Swivel support allowing the panel to be oriented or tilted in any position.  
Soporte giratorio que permite que el panel sea girado o inclinado en cualquier posición.  
Infotafel ist drehbar und kann in jeder Position fixiert werden

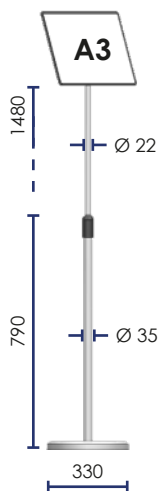

\* Livré avec réglette support menu  
Delivered with a menu support strip  
Entregado con una tira de soporte de menú  
Auflegeleiste inklusive

SWP 4 ROT

SWP 3 ROT

SWP 2 ROT

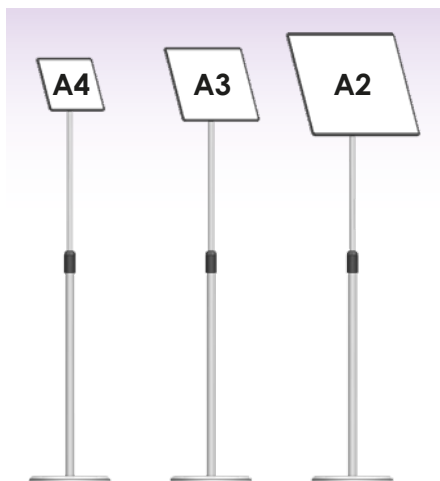





# SWP FIX



Créa Luxe.fr

## POTEAU D'INFORMATION - HAUTEUR FIXE

INFORMATION POST ◦ POSTE DE INFORMACIÓN

INFO PFOSTEN - NICHT HÖHEN VERSTELLBAR



	A4	A3	A2
●	SWP 4 FIX CH	SWP 3 FIX CH	SWP 2 FIX CH
●	SWP 4 FIX BK	SWP 3 FIX BK	SWP 2 FIX BK
●	SWP 4 FIX JA	SWP 3 FIX JA	SWP 2 FIX JA
●	SWP 4 FIX NJ	SWP 3 FIX NJ	SWP 2 FIX NJ
●	SWP 4 FIX RO	SWP 3 FIX RO	SWP 2 FIX RO
●	SWP 4 FIX RB	SWP 3 FIX RB	SWP 2 FIX RB
●	SWP 4 FIX OR	SWP 3 FIX OR	SWP 2 FIX OR
●	SWP 4 FIX VE	SWP 3 FIX VE	SWP 2 FIX VE
●	SWP 4 FIX BU	SWP 3 FIX BU	SWP 2 FIX BU
○	SWP 4 FIX WH	SWP 3 FIX WH	SWP 2 FIX WH
●	SWP 4 FIX GR	SWP 3 FIX GR	SWP 2 FIX GR

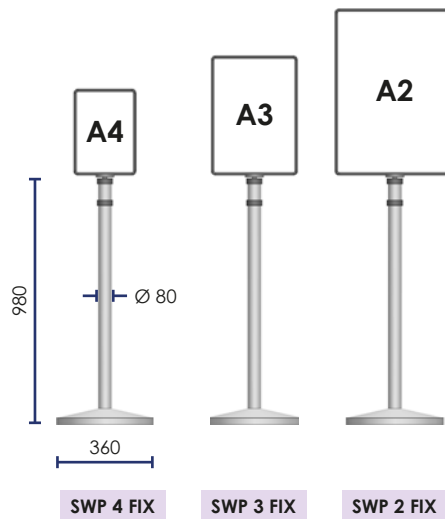

	A4	A3	A2
●	SWPO 4 CH	SWPO 3 CH	SWPO 2 CH
●	SWPO 4 BK	SWPO 3 BK	SWPO 2 BK
●	SWPO 4 JA	SWPO 3 JA	SWPO 2 JA
●	SWPO 4 NJ	SWPO 3 NJ	SWPO 2 NJ
●	SWPO 4 RO	SWPO 3 RO	SWPO 2 RO
●	SWPO 4 RB	SWPO 3 RB	SWPO 2 RB
●	SWPO 4 OR	SWPO 3 OR	SWPO 2 OR
●	SWPO 4 VE	SWPO 3 VE	SWPO 2 VE
●	SWPO 4 BU	SWPO 3 BU	SWPO 2 BU
○	SWPO 4 WH	SWPO 3 WH	SWPO 2 WH
●	SWPO 4 GR	SWPO 3 GR	SWPO 2 GR



Rotule permettant d'orienter ou d'incliner le panneau dans tous les positions.  
Swivel allowing the panel to be oriented or tilted in any position.  
Giratorio que permite que el panel sea girado o inclinado en cualquier posición.  
Infotafel ist drehbar und kann in jeder Position fixiert werden

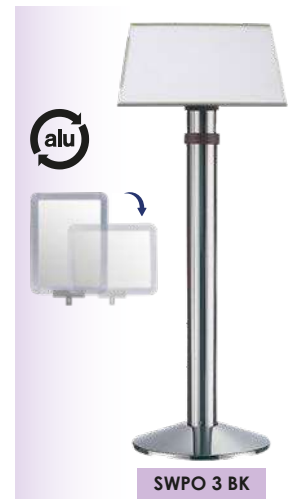
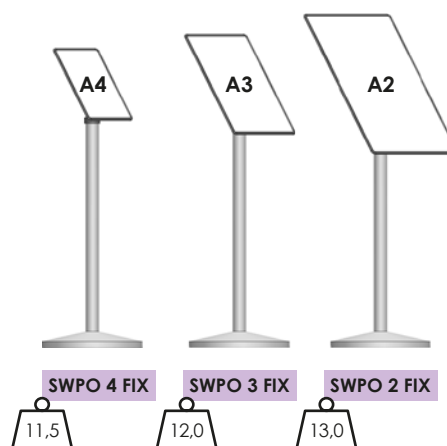

### SWPO 3

Livré avec réglette support menu  
Delivered with a menu support strip  
Entregado con una tira de soporte de menú  
Aufgabeleiste inklusive



PPC

REXO 4 / 3

**POTEAU D'INFORMATION - HAUTEUR FIXE**

INFORMATION POST ◦ POSTE DE INFORMACIÓN

INFO PFOSTEN - NICHT HÖHEN VERSTELLBAR

ACIER ◦ STEEL ◦ ACERO ◦ STAHL



ABS

	A4	A3
●	REXO CH 4	REXO CH 3
●	REXO BK 4	REXO BK 3
●	REXO GO 4	REXO GO 3



7,4

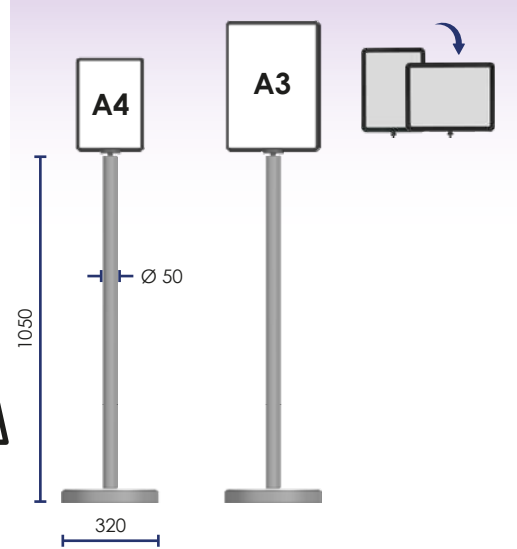

PLASTIQUE ◦ PLASTIC ◦ PLÁSTICO ◦ KUNSTOFF



ABS

	A4
○	PPC A4 B
●	PPC A4 G
●	PPC A4 N

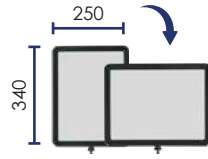

PPC A4 B

PPC A4 G

PPC A4 N

6,0

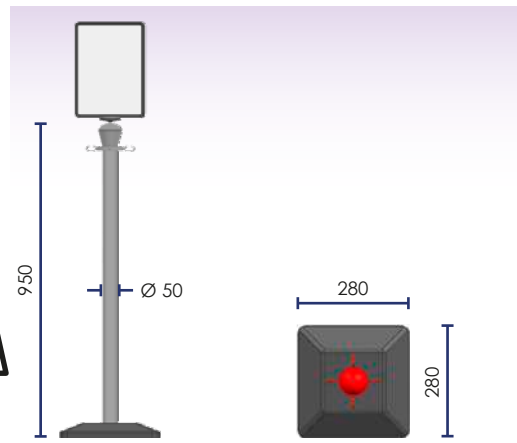





# REXURN

## URNE SUR POTEAU BALLOT BOX ON POST ◦ URNA SOBRE POSTE SAMMELBOX FÜR DEN PFOSTEN



Code		
REXURN 300 CH		500
REXURN 300 LA		
REXURN 300 BK		
REXURN 400 CH		1000
REXURN 400 LA		
REXURN 400 BK		

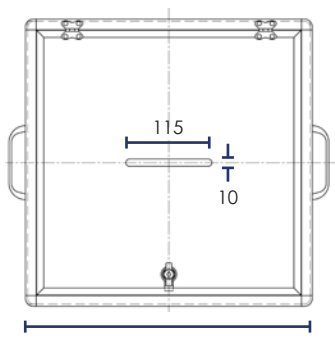

REXURN 400 ▶ 400 x 400  
REXURN 300 ▶ 300 x 300

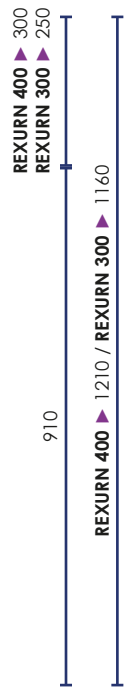

7,4

REXURN 300 CH



REXO V / H

©rea-Luxe.fr

**POTEAU SUPPORT CATALOGUE**  
**BROCHURE HOLDER POST** ◦ **POSTE PORTA FOLLETO**  
**PFOSTEN ABLAGE FÜR KATALOGE / PROSPEKTE**



Code		
REXO CH V		
REXO LA V		
REXO BK V		
REXO CH H		
REXO LA H		
REXO BK H		

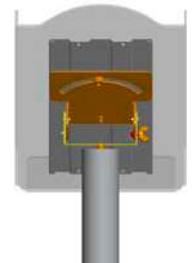
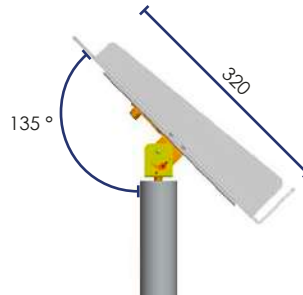
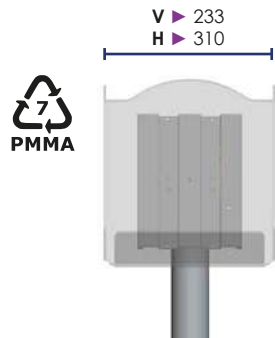

REXO CH H

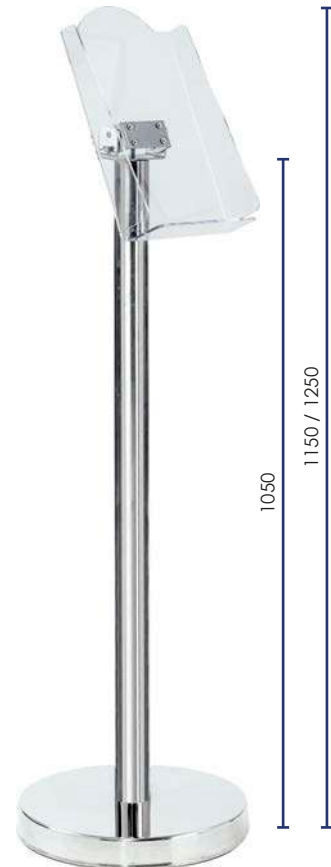

REXO CH V





Élections Régionales

Élections Régionales

RUE AMBETTA

3

2

1





PEL



Créa Luxe.fr

ISO

## PANNEAU ELECTORAL

ELECTION POSTER BOARD ◦ CARTELERA ELECTORAL  
PLAKATWAND



Ø 35 x 1,2



GALVA

Code		
PEL 1023	2300 x 1085	20,0
PEL 1523	2300 x 1585	30,5



OPTION ◦ OPTIONAL  
OPCIÓN ◦ OPTIONAL



PEL FEET2



Avec 2 crochets  
With 2 hooks  
Con 2 ganchos  
Mit 2 Halterungen

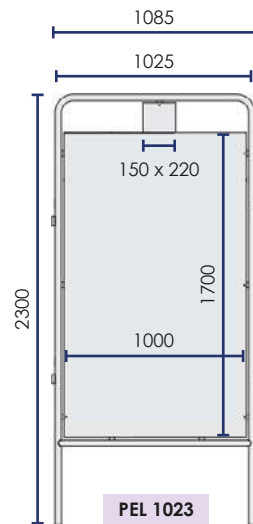

PEL 1023

1 candidat

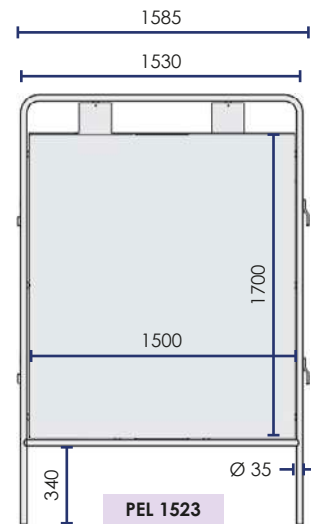

PEL 1523

2 candidats

## ISOLOIR

VOTING BOOTH  
CABINA DE VOTACIÓN ◦ WAHLKABINE



PEINTURE ÉPOXY  
POWDER PAINTING  
PINTURA EPOXICA  
EPOXY FARBE

Code		
ISO 800	800 x 800	16
ISO 1300	1000 x 1300	21

Rideaux ignifugés ◦ Fireproof curtains  
Cortinas ignífugas ◦ Feuerfeste Vorhänge



ISO 1300



ISO 800



Liaison  
Link  
Enlace  
Verbindung

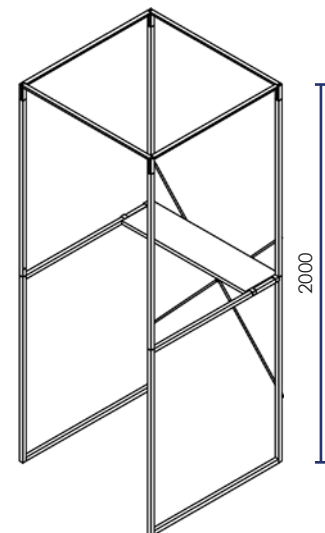

OPTION ◦ OPTIONAL  
OPCIÓN ◦ OPTIONAL



ISO BAG





URNOF

## URNE OFFICIELLE AVEC COMPTEUR

BALLOT BOX WITH COUNTER ◦ URNA DE VOTO CON CONTADOR

WAHLURNE MIT ZÄHLWERK



Code	L	W	H	kg
URNOF 600	30	1200	350 x 350 x 250	2,3
URNOF 1200	60	2400	400 x 400 x 350	4,4



Compteur intégré  
Counter integrated  
Contador integrado  
Inklusive Zählwerk



2 poignées  
2 handles  
2 manijas  
2 Tragegriffe



2 charnières  
2 hinges  
2 bisagras  
2 Metallscharniere



Coins renforcés  
Reinforced corners  
Esquinas reforzadas  
Schutzecken



Fermeture par 2 cadenas différents inclus  
Closing by 2 different padlocks included  
Cierre por 2 candados diferentes incluidos  
Schließung durch 2 Vorhangschlösser

URN

# URNE

BALLOT BOX ◦ URNA  
WAHLURNE



Code				
URN 300	25	400 / 500	300 x 300 x 250	1,5
URN 400	48	800 / 1000	400 x 400 x 300	2,0

Fente 115 x 10  
Opening  
Apertura  
Einwurfgröße



Fermeture par clés  
Closing by keys  
Cierre con llaves  
Schließung durch Schlüssel



URN 300



URN 400



Coins renforcés  
Reinforced corners  
Esquinas reforzadas  
Schutzecken

Code				
URN 250	15	300 / 400	∅ 200 x 250	1,5
URN 750	50	1000 / 1200	∅ 200 x 750	3,1

Fente 115 x 10  
Opening  
Apertura  
Einwurfgröße



Fermeture par clés  
Closing by keys  
Cierre con llaves  
Schließung durch Schlüssel

Mousse dans le fond  
Foam at the bottom  
Espuma en el fondo  
Schaumstoff für den Boden



URN 250



URN 750





## CASIER POUR EFFETS PERSONNELS

LOCKER FOR PERSONAL BELONGINGS

LOCKERS PARA OBJETOS PERSONALES

AUFWAHRUNGSFÄCHER FÜR PERSONAL



Code	
CAS20TEL	525 x 420 x 180



20 clés différentes  
20 different keys  
20 llaves diferentes  
20 unterschiedliche Schlüssel



Charnières acier nickelé  
Nickel plated hinges  
Bisagras de acero niquelado  
Scharniere verchromt

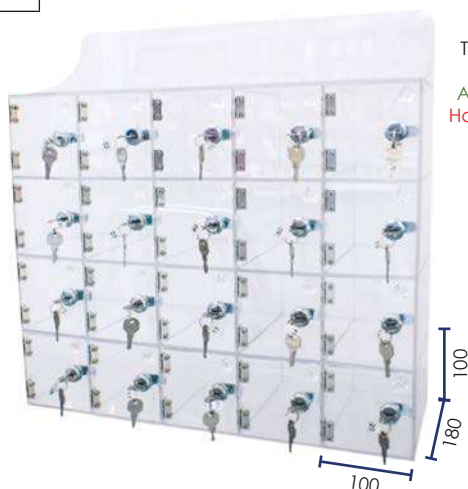

Trous d'accrochage  
Hanging hooks  
Agujeros para colgar  
Haken zum Aufhängen

## COLLECTEUR DE PILES ET CARTOUCHES

BATTERIES AND CARTRIDGES COLLECTOR

COLECTOR DE BATERIAS Y CARTUCHOS

SAMMELBEHÄLTER FÜR BATTERIE & DRUCKERPATRONEN



Code		
BAT 250		7
BAT 750		20
BCC 250		7
BCC 750		20

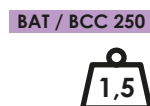

Couvercle amovible  
Removable lid  
Cubierta desmontable  
Deckel abnehmbar

Mousse dans le fond  
Foam at the bottom  
Espuma en el fondo  
Schaumstoff für den Boden



## CADENAS

PADLOCK

CANDADO

VORHANGSCHLOSS

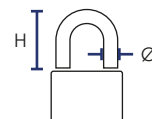

Code	Ø	H	kg
CADSTOP	6	62	0,14
CAD 203 NP (x 3)	2,5	15	0,02
CAD 301 SB / NP	4,4	23	0,04
CAD 401 SB / NP	5	30	0,07
CAD 501 NP	6	35	0,13
CAD 701 G SB	12	60	0,53



CADSTOP



CAD 501 NP



Code	Ø	H	kg
CBAG SB	4	20	0,02
CA 3 COM SB	3	25	0,02
CL 4 COM SB / NP	5	32	0,14



CBAG SB



CA 3 COM SB



CL 4 COM SB







RAMP

ADJ 1100

## RAMPE D'ACCÈS TRANSPORTABLE

TRANSPORTABLE ACCESS RAMP ◦ RAMPA DE ACCESO PORTÀTIL ◦ MOBILE RAMPEN

Code		kg maxi	kg
ADJ 1100	1120 (1010) x 750 x 160	300	9

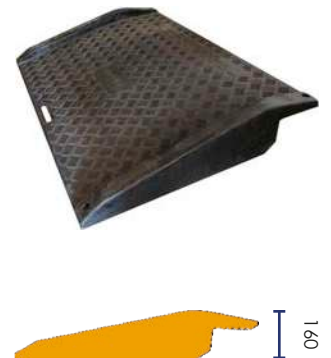
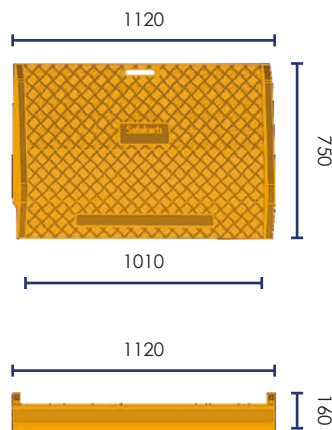

## PLIANTES ◦ FOLDABLE ◦ PLEGABLE ◦ FALTBARE

Code		kg maxi	kg
RAMP 125	1220 x 710 x 50	300	9,2
RAMP 178	1830 x 710 x 50	300	13,8



Bavette ajustable  
Adjustable plate  
Placa ajustable  
Einstellbarer Schaufel

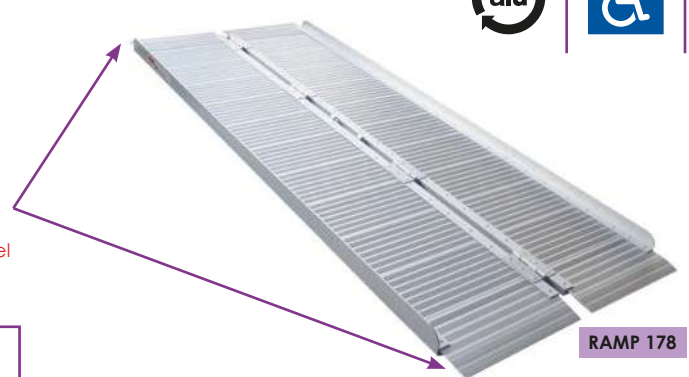

RAMP 178

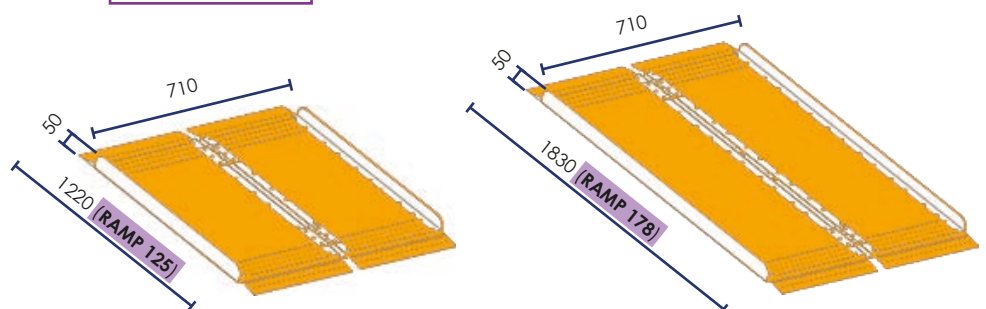











M4161 / 5177

M 450 / 600 / 800

## MIROIR DE SÉCURITÉ

MIRROR ◦ ESPEJO ◦ SICHERHEITSSPIEGEL



Code	 m	
M 450	10	
M 600	15	130°
M 800	25	

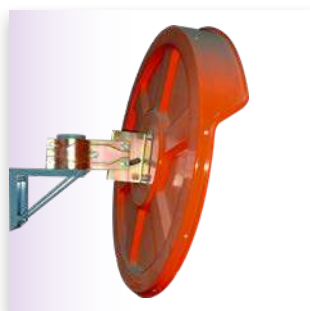

M 450





M 600



M 800



Code	 m	
M 4161	10	
M 5177	20	130°



M 4161



M 5177



INCLUS ◦ INCLUDED ◦ INCLUIDO ◦ INKLUSIVE

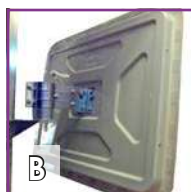
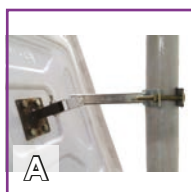



Avec fixation Ø 60 mm selon modèle (A / B)  
With fixation depending on model (A / B)  
Con fijaciones según referencia (A / B)  
Mit Befestigung nach Modell (A / B)



## MIROIR INTÉRIEUR DE SÉCURITÉ

INDOOR USE SAFETY MIRROR ◦ ESPEJO INTERIOR DE SEGURIDAD  
INNEN BEOBACHTUNGSSPIEGEL



Code	 m	
MS 90	10	90°
MS 180	15	180°
MS 360	25	360°



Ø 650 (1/4)

MS 90



Ø 650 (1/2)

MS 180



Ø 650



MS 360



## MIROIR DE SÉCURITÉ

MIRROR ◦ ESPEJO ◦ SICHERHEITSSPIEGEL



Code	 m	
MIROIR	5	130°

Tige flexible 30 cm  
Flexible stem  
Varilla flexible  
Flexibler Stab



Ø 330

MIROIR

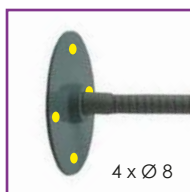









**PSG 680**

## BALISE CHEVALET INOX

**STAINLESS STEEL FLOOR SIGN** ○ **BALIZA DE SUELO EN ACERO INOXIDABLE**  
**WARNAUFSTELLER AUS INOX**



Verrouillage ouverture  
 Opening lock  
 Bloqueo apertura  
 Verriegelung der Öffnung

A personnaliser avec des stickers ou sur demande  
 To customize with stickers or on request  
 Personalización con adhesivos o bajo pedido  
 Individuelle Sticker  
 Ausführung auf Anfrage

## CHEVALET SOL

**FLOOR SIGN** ○ **BALIZA DE SUELO**  
**WARNAUFSTELLER**



+ livré avec 2 x 2 stickers  
 + delivered with 2 x 2 stickers  
 + suministrado con 2 x 2 pegatinas  
 lieferbar mit 2 x 2 Warnsticker

NETTOYAGE  
 NETTOYAGE  
 EN COURS  
 WORK  
 IN PROGRESS  
 ACHTUNG!  
 REINIGUNG  
 LIMPIEZA  
 EN CURSO

ATTENTION  
 ATTENTION  
 CAUTION  
 CUIDADO  
 ACHTUNG  
 ATTENZIONE

A personnaliser avec des stickers ou sur demande  
 To customize with stickers or on request  
 Personalización con adhesivos o bajo pedido  
 Individuelle Sticker  
 Ausführung auf Anfrage





PSG 700

**CHEVALET SOL PREMIUM**  
 PREMIUM FLOOR SIGN ◦ BALISA DE SUELO PREMIUM  
 WARNAUFSTELLER IN PREMIUM QUALITÄT



PSG 700 BU



PSG 700 RO



PSG 700



A personnaliser avec des stickers ou sur demande  
 To customize with stickers  
 or on request  
 Personalizable con pegatinas o a petición  
 Individuelle Sticker Ausführung auf Anfrage

Poignée ergonomique  
 Ergonomic handle  
 Mango ergonómico  
 Ergonomischer Griff

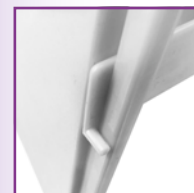

PSGI 700



PSGG 700



PSGP 700



PSGE 700



PSGATT 700



PSGD 700



PSGT 700



PSGSI 700



PSGNOPASS 700



PSGTVX 700



CSL



Créa Luxe.fr

PSG 501

## CÔNE PARAPLUIE SOL GLISSANT

POP UP WET FLOOR SIGN ◦ CONO PLEGABLE SUELO MOJADO

WARNAUFSTELLER MIT HINWEIS «RUTSCHGEFAHR»

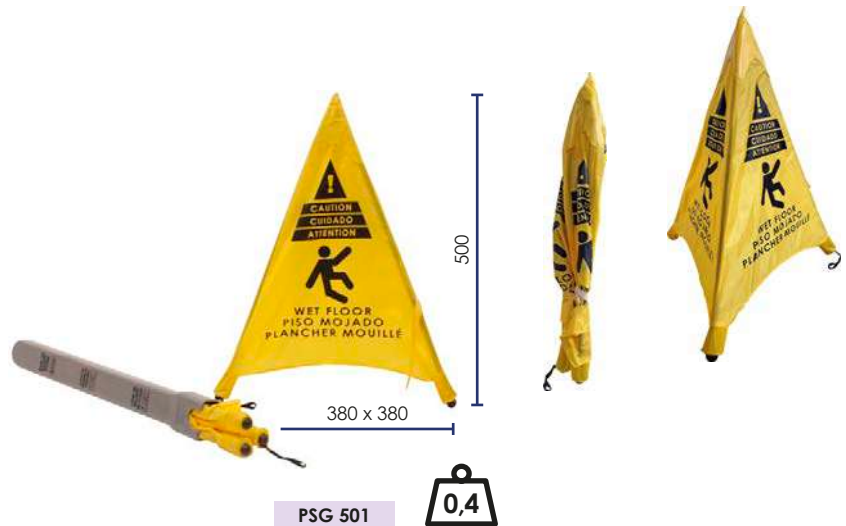

## BALISE DE RUE

BLACK CUSTOMIZABLE CONE ◦ BALIZA ◦ STRASSEN LEITBAKE



Classe 1  
Class 1  
Clase 1  
Klasse 1



Réfléchissant  
Reflective  
Reflectante  
Reflektierende

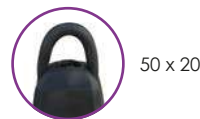

Personnalisation : mini 100  
Customization mini 100  
Personalización mini 100  
Personalisierung : Mini 100

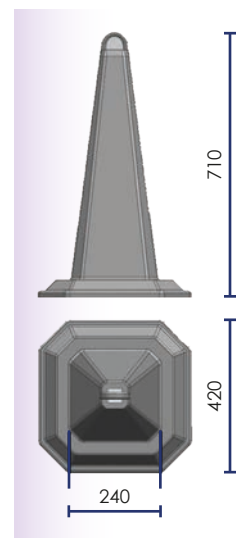









RSNT 100



RSA

**RUBAN DE BALISAGE** ◦ MARKING TAPE ◦ CINTA DE SEÑALIZACIÓN ◦ BODENMARKIERUNG

**ADHÉSIF** ◦ ADHESIVE ◦ ADHESIVO ◦ Klebstoff



Code		
RSA 335 STOP NJ		x 6
RSA 335 NJ		x 6
RSA 335 RB		x 6



RSA 335 STOP NJ



RSA 335 NJ



RSA 335 RB



**ANTI-DÉRAPANT** ◦ NON SKID ◦ ANTIDESLIZANTE ◦ ANTIRUTSCH VERSION



Code		
RSA 550 BK		x 6
RSA 550 NJ		x 6
RSA 550 RB		x 6
RSA 550 BYB		x 6

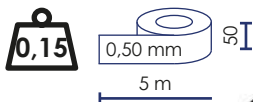

RSA 550 BYB

Code		
RSA 5100 BK		x 1
RSA 5100 NJ		x 1

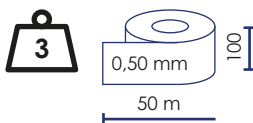

RSA 5100 BK

**RÉFLÉCHISSANT ET ANTI-DÉRAPANT \*** ◦ NON SKID AND REFLECTIVE  
REFLECTIVO Y ANTIDESLIZANTE ◦ REFLEKTIEREND & ANTIRUTSCH VERSION



Code		
RSNT 100 JA		x 1
RSNT 100 BL		x 1
PODGLUE2 *		

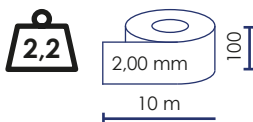

\* A poser avec colle ◦ To fix with glue ◦ Usar pegamento ◦ Befestigung durch Kleber



Colle époxydique souple 2 composants pour béton  
Flexible 2-component epoxy adhesive for concrete  
Adhesivo epoxidico flexible de 2 componentes para hormigón  
2-Komponenten Kleber für Beton





PDM



NDM

## NEZ DE MARCHE ANTIDÉRAPANT ○ NON-SLIP STAIR NOSING PERFIL ANTIDESLIZANTE PARA PELDAÑOS ○ RUSTCHFEST TREPPENKANTENPROFIL



Code			
NDM 900 PVC		3 x 5 mm	0,80
NDM 900 BK			0,80
NDM 900 FLUO			0,80
NDM 1300 PVC		4 x 5 mm	1,20
NDM 1300 BK			1,20
NDM 1300 FLUO			1,20

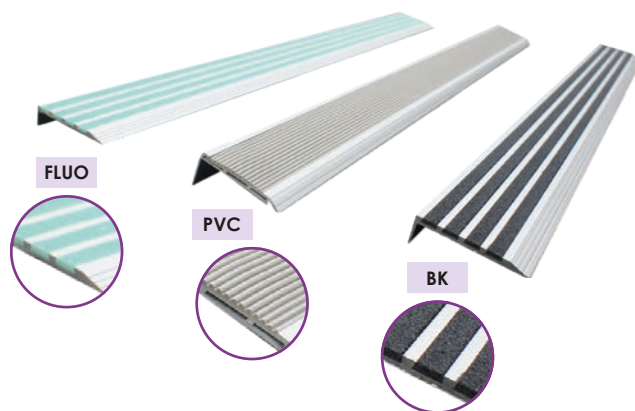

non fourni ○ not supplied ○ no incluido ○ nicht enthalten

NDM 900



900



NDM 1300



1300



## PLAT DE MARCHE ○ STAIRS PAD PERFIL ANTIDESLIZANTE PARA PELDAÑOS ○ TREPPENKANTEN



Code			
PDM 900 PVC		3 x 5 mm	0,80
PDM 900 BK			0,80
PDM 1300 PVC		4 x 5 mm	1,10
PDM 1300 BK			1,10

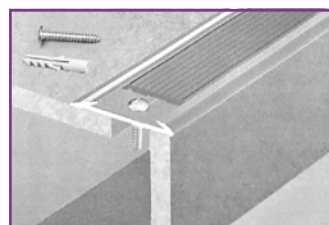

non fourni ○ not supplied ○ no incluido ○ nicht enthalten

PDM 900



900



PDM 1300



1300

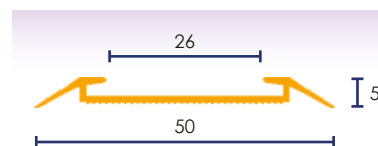

OPTION  
OPCIÓN  
OPCIÓN



RQ GLUE





## ADHÉSIF POUR MARQUAGE AU SOL EXTÉRIEUR

OUTDOOR WARNING FLOOR STICKER

ADHESIVO DE MARCADO PARA USO EXTERIOR

BODENMARKIERUNGEN EXTERNE ANWENDUNG



## ANTI-DÉRAPANT

NON SKID ◦ ANTIDESLIZANTE ◦ ANTIRUTSCH VERSION



Impression sur vinyle adhésif antidérapant spécialement conçu pour asphalte, trottoirs ou béton.

Printing on non-slip adhesive vinyl specially designed for asphalt, sidewalks or concrete.

Impresión sobre vinilo adhesivo antideslizante especialmente diseñado para asfalto, aceras u hormigón.

Druck auf rutschfestem Klebevinyl, speziell für Asphalt, Gehwege oder Beton

SOLEX 560 HAND

600 x 500



SOLEX 500 STAT

Ø 500



SOLEX 500 OBLI

Ø 500



SOLEX 500 PIET

Ø 500



SOLEX 500 SENS

Ø 500



SOLEX 305 FLEC

30 x 5 cm

x 5

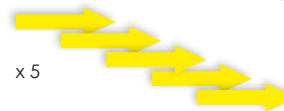

SOLEX 280 PAS

28 x 10 cm

x 10 (5 + 5)



SOLEX 845 PERS

80 x 45 cm

x 2



SOLEX 100 ZEBRA

100 x 25 cm

x 3

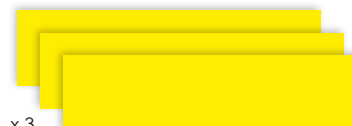

SOLEX 453 CHUT

45 x 35 cm



SOLEX 453 TOMB

45 x 35 cm







SAN 500

**ADHÉSIF POUR MARQUAGE INTÉRIEUR**  
**INDOOR WARNING STICKER**  
**ADHESIVO DE MARCADO INTERIOR**  
**WARN- & VERBOTSSCHILDER INNENBEREICH**



**STANDARD**

**SOL 350 RSTOP**  
 Ø 350



**SOL 500 RCHAR**  
 Ø 500



**SOL 500 RFUM**  
 Ø 500



**SOL 500 RINT**  
 Ø 500



**SOL 500 ROBLI**  
 Ø 500



**SOL 500 RPIET**  
 Ø 500



**SOL 500 RSENS**  
 Ø 500



**ANTI-DÉRAPANT**  
**NON SKID**  
**ANTIDESLIZANTE**  
**ANTIRUTSCH VERSION**



**SAN 500 TCHAR**  
 500 x 500 x 500



**SAN 500 TELEC**  
 500 x 500 x 500



**SAN 500 TGLIS**  
 500 x 500 x 500



**SAN 500 CEXT**  
 500 x 500





EXPOSITION



EXPOSITION



## SIGNAC COLLECTIONNEUR

12-10-2021 > 13-02-2022  
Niveau 0, espace d'exposition temporaire

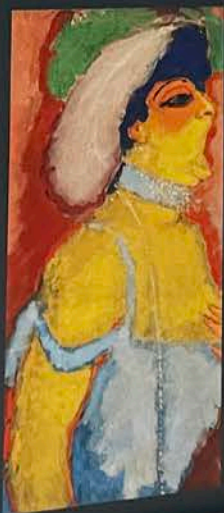

## ENFIN LE CINÉMA !

ARTS, IMAGES ET SPECTACLES EN FRANCE (1833-1907)

22-09-2021 > 16-01-2022  
Niveau 0, espace d'exposition temporaire







STICK

ESA

**SIGNALÉTIQUE ADHÉSIVE** ○ **ADHESIVE SIGNS**  
**SEÑALIZACIÓN ADHESIVA** ○ **WARNSTICK SELBSKLEBEND**

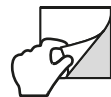

115 X 115 x 10

 ESA 01	 ESA 03	 ESA 06	 ESA 11	<b>WC</b> ESA 13	 ESA 16
 ESA 02	 ESA 04	 ESA 07	 ESA 12	 ESA 14	 ESA 17
	 ESA 05	 ESA 08	 ESA 12ST	 ESA 15	

58 X 21 + Ø 43 x 10

  
PAS de PUBLICITÉ S.V.P.

  
PAS de PUBLICITÉ S.V.P.







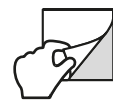



LAPDP



**SIGNALÉTIQUE ADHÉSIVE TRANSPARENTE**  
**TRANSPARENT ADHESIVE SIGNS** ○ **SEÑALIZACIÓN ADHESIVA TRANSPARENTE**  
**WARNSTICK SELBSKLEBEND - TRANSPARENT**



200 X 200 x 2

		 STICK CHANTIER	 STICK DANGER	 STICK ELECT	 STICK CHUTE													
		 STICK NOPASS	 STICK NOPIETON	 STICK INTERDIT	 STICK NOPARK													
		<table border="1" data-bbox="734 1937 869 2049"> <tr><td>ATTENTION</td></tr> <tr><td>CAUTION</td></tr> <tr><td>CUIDADO</td></tr> <tr><td>ACHTUNG</td></tr> <tr><td>ATTENZIONE</td></tr> </table> STICK TEXT1	ATTENTION	CAUTION	CUIDADO	ACHTUNG	ATTENZIONE	<table border="1" data-bbox="949 1937 1085 2049"> <tr><td>NETTOYAGE</td></tr> <tr><td>EN COURS</td></tr> <tr><td>WORK</td></tr> <tr><td>IN PROGRESS</td></tr> <tr><td>ACHTUNG !</td></tr> <tr><td>REINIGUNG</td></tr> <tr><td>LIMPIEZA</td></tr> <tr><td>EN CURSO</td></tr> </table> STICK TEXT2	NETTOYAGE	EN COURS	WORK	IN PROGRESS	ACHTUNG !	REINIGUNG	LIMPIEZA	EN CURSO		
ATTENTION																		
CAUTION																		
CUIDADO																		
ACHTUNG																		
ATTENZIONE																		
NETTOYAGE																		
EN COURS																		
WORK																		
IN PROGRESS																		
ACHTUNG !																		
REINIGUNG																		
LIMPIEZA																		
EN CURSO																		



## CHIFFRE AUTOCOLLANT

SELF-ADHESIVE NUMBER ◦ NÚMERO DE SEÑALIZACIÓN ADHESIVO  
ZAHLEN SELBSTKLEBEND

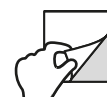

56 X 80

x 10



0

CA 0

1

CA 1

2

CA 2

3

CA 3

4

CA 4

5

CA 5

6

CA 6

7

CA 7

8

CA 8

9

CA 9

## CHIFFRES ET LETTRES ADHÉSIFS

ADHESIVE LETTERS AND NUMBERS ◦ LETRAS Y NÚMEROS ADHESIVOS  
ZAHLEN UND BUCHSTABEN SELBSTKLEBEND

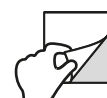

A

60

LA60N



	A	B	C	D	E	F	G	H	I	J	K	L	M	N	O
	3	3	2	2	5	1	2	2	12	2	2	6	2	5	2

	P	Q	R	S	T	U	V	W	X	Y	Z	€	Ø	.
	2	1	3	4	4	4	2	1	1	1	1	1	1	33

3

60

CA60N



	0	1	2	3	4	5	6	7	8	9	€	-	+	.	,
	5	14	3	3	3	5	3	3	3	3	2	1	1	22	2





Créa Luxe.fr

## CHIFFRES DE RUE

STREET NUMBERS ◦ NÚMERO DE SEÑALIZACIÓN ◦ HAUSNUMMER

ADHÉSIF FINITION DORÉE ◦ GOLDEN FINISH SELF ADHESIVE  
ADHESIVO ACABADO DORADO ◦ SELBSTKLEBEND - GOLDFARBIG

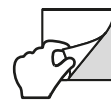

H 40 MM | x 5



0 1 2 3 4 5 6 7 8 9

CALT 0

CALT 1

CALT 2

CALT 3

CALT 4

CALT 5

CALT 6

CALT 7

CALT 8

CALT 9

## À CLOUER ◦ TO NAIL

A CLAVAR ◦ ZUM NAGELN



H 80 MM | x 5

INCLUS ◦ INCLUDED  
INCLUIDO ◦ INKLUSIVE



0 1 2 3 4 5

CRZ 0

CRZ 1

CRZ 2

CRZ 3

CRZ 4

CRZ 5

6 7 8 9 BIS TER

CRZ 6

CRZ 7

CRZ 8

CRZ 9

CRZ BIS

CRZ TER

0 1 2 3 4 5

CZL 0

CZL 1

CZL 2

CZL 3

CZL 4

CZL 5

6 7 8 9 BIS TER

CZL 6

CZL 7

CZL 8

CZL 9

CZL BIS

CZL TER

# SÉRIE S

# PALU

## PANNEAU ALUMINIUM ADHÉSIF

ADHESIVE ALUMINUM SIGN ◦ PANEL ADHESIVO ALUMINIO  
HINWEISSCHILDER AUS ALUMINIUM - SELBSTKLEBEND



Ø 80 MM x 5

 PALU 1	 PALU 2	 PALU 3	 PALU 4	 PALU 5	 PALU 6	 PALU 7	 PALU 8
 PALU 9	 PALU 10	 PALU 11	 PALU 12	 PALU 13	 PALU 14	 PALU 15	

## PANNEAU ADHÉSIF

ADHESIVE SIGN ◦ PANEL ADHESIVO  
HINWEISSCHILDER - SELBSTKLEBEND

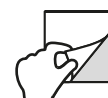

170 X 50 x 5



 S 2A	 S 11	 S 14	 S 24
 S 28	 S 29	 S 31	 S 32
 S 33	 S 34	 S 35	 S 36
 S 37	 S 38	 S 39	 S 40
 S 41			





**PANNEAU ADHÉSIF**  
 ADHESIVE SIGN ◦ PANEL ADHESIVO  
 HINWEISSCHILDER - SELBSTKLEBEND



Ø 180 MM x 5



DPP 1



DPP 2



DPP 2ST



DPP 3



DPP 4

Ø 280 MM x 5



DPE 2



DPE 3



DPE 6BD



DP 8



DP 10



DP 11



DP 12



DP 13



DP 14



DP 15



DP 16



DP 17



DP 18



DP 19



DP 20



DP 21



DP 22



DP 23



DP 24



DP 25



**PANNEAU ADHÉSIF**  
 ADHESIVE SIGN ◦ PANEL ADHESIVO  
 HINWEISSCHILDER - SELBSTKLEBEND

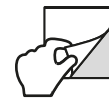

Ø 280 MM | x 5



DPO 30



DPO 31



DPO 32



DPO 33



DPO 34



DPO 35



DPO 36



DPO 37



DPO 38



DPO 39



DPO 40

320 X 120 | x 5



LPR 33



LPR 34



LPR 35



LPR 36



LPR 37



LPC 38

(200 X 200)

280 X 190 | x 5



LP 2



LP 12



LP 15



LP 16



LP 17



LP 30



LP 31



LP 32



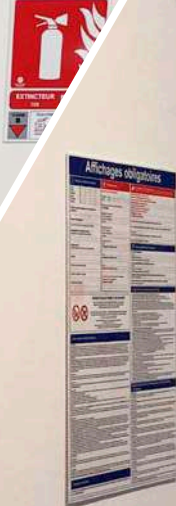

PANNEAU AFFICHAGE LÉGAL  
FRENCH LEGAL MENTION SIGN  
PANEL OBLIGACIONES LEGALES (FRANCIA)  
SICHERHEITS- UND HINWEISTAFEL



300 X 400 x 5



PAO 300



PNAE 300



PNUR 300 S



A series of horizontal lines for writing, starting from the top line and extending down to the bottom of the page.





## FIXATION UNIVERSELLE

UNIVERSAL FIXING  
FIJACIÓN UNIVERSAL  
BEFESTIGUNGSMITTEL  
UNIVERSAL

	Code			
	FIX 1 SB	x 1	Ø 12 x 130	0,07
	FIX 4 SB	x 4		0,12
	FIX 34 SB	x 34		2,80
	FIX 164 SB	x 4	Ø 12 x 160	0,35
	TPU FIX 1 SB	x 1	Ø 12 x 80	0,07
	BAR FIX 1 SB	x 1	Ø 12 x 80	0,07
	BAR FIX 8 SB	x 8		0,07
	BAR FIX 304 SB	x 4	Ø 12 x 100	0,35

## FIXATION BÉTON





CONCRETE FIXING  
FIJACIÓN HORMIGÓN  
BEFESTIGUNGSMITTEL  
BETON

	Code				
	FIX SAFE	x 1	Ø 12 x 120	0,15	
	FSAFE 2 SB	x 2		0,32	
	FSAFE 4 SB	x 4		0,64	
	FSAFE 12 SB	x 12		1,94	
	FIX 253 SB	x 3	Ø 16 x 250	2,80	► BUT 1200
	RR FIX 4 SB	x 4	2 x Ø 6 x 60 2 x Ø 10 x 100	0,20	► RR 35 / 100 / 150 / 200
	FIX WP 244 SB	x 4	Ø 10 x 100	0,40	► WP 240
	CP 5 FIX SB	x 4	Ø 6 x 60	0,20	► CP 5040















**FIXATION**  
**ASPHALTE**  
 ASPHALT FIXING  
 FIJACIÓN ASFALTO  
 BEFESTIGUNGSMITTEL  
 ASPHALT

	Code					
	SPIKES	x 1		0,25		
	SPIKE 2 SB	x 2		Ø 12 x 300	0,50	
	SPIKE 4 SB	x 4		1,00		
	SPIKE 253 SB	x 3	Ø 14 x 350	0,95	► BUT 1200	
	SPIKE WP 244 SB	x 4	Ø 10 x 300	0,80	► WP 240	
	CP5 SPIKE SB	x 4	Ø 6 x 300	0,60	► CP 5040	
	RR SPIKE 4 SB	x 4	2 x Ø 6 x 60 2 x Ø 10 x 100	0,60	► RR 35 / 100 / 150 / 200	

**H DE LIAISON**  
 H LINK  
 H DE UNIÓN  
 H BEFESTIGUNGSMITTEL

	Code					
	GEY 1 SB	x 1		0,25		
	GEY 2 SB	x 2		80 x 45	0,50	
	GEY 14 SB	x 14		1,00		
	SPEED H 4 SB	x 4		0,95	► EASYSPEED / FAST 60 / SAFETY	
	SAFETY 25 H 4 SB	x 4		0,80	► SAFETY 25	
	EASYFAST 4 H SB	x 4		50 x 30	0,60	► EASYFAST

**COLLE**  
 GLUE  
 PEGAMENTO  
 KLEBEMITTEL

	Code		
	RQ GLUE	Colle polymère 290 ml Polymer glue 290 ml Pegamento polímero 290 ml Polymerkleber 290 ml	0,50
	POD GLUE	Colle époxyuréthane bicomposant Two-component epoxy adhesive Adhesivo epoxi de dos componentes Zweikomponenten-Epoxid-Urethan-Klebstoff	5,00
	POD GLUE 2		2,00
	PODSEAL	Scellement chimique 300 ml Chemical sealant 300 ml Sellador químico 300ml Chemische Versiegelung 300 ml	



<b>A</b>		
ADJ1100	103 / 258	
AK5LED	106	
APB / N / R 804SB	175	
APF801R / N / B SB	175	
APO801B / N / R SB	175	
APV80E	188	
ATC / ATL 01SB	236 / 238	
<b>B</b>		
B1500	185 / 243	
BAL105TUB	179	
BAL110	176	
BAL11CRF	176	
BAL170KIT / EXT	179	
BAL2110 / EXT	177	
BAL215RB / EXT	177	
BAL2201RB / EXT	178	
BAL2202RB / EXT	178	
BAL33	176	
BAL370KIT	179	
BAL4100RB	178	
BAL4200	178	
BAL6110	177	
BALKIT / EXT	179	
BALKITWIND / EXT	179	
BAR KIT / EXT	186 / 242	
BAR001RB	108	
BAR002RB	108	
BAR03RB	107	
BAR104 / 134	51 / 113	
BAR1020 / 2020	50 / 112	
BAR1275 / 1210	141	
BAR14 / 18	49	
BAR204 / 234 / 244	51 / 113	
BAR3000 / BAR3EXT	109 / 192	
BAR3575 / 3510	141	
BAR37	141	
BAR400 / 415 / 420	134	
BAR400 / 415 / 420 GAL	56 / 134	
BAR400 / 415 / 420 INOX	56 / 134	
BAR4000 / FIX	109 / 193	
BAR4006	109 / 193	
BAR4KIT	193	
BAR500GAL	56 / 135	
BAR600 / 615 / 620	135	
BAR600 / 615 / 620 GAL	56 / 135	
BAR6075 / 6010	141	
BARA3566 / 6066 / 1266	143	
BARCAM3	47	
BARELEC	108	
BARP	140	
BAS2000V	54	
BASE2500	50 / 112 / 117 / 197	
BASE310	50 / 112	
BAS40 / 60	55 / 137	
BAS400 / 405 / 2930	136	
BAS400 / 405 GAL	54 / 136	
BAS600 / 615 / 620	136	
BAS600 / 615 / 620 GAL	54 / 136	
BAS600V	54 / 136	
BASOL40 / 60	55 / 137	
BAT250 / 750	256	
BBASE40 / 60	55 / 137	
BCC250 / 750	256	
BEKO100	187	
BKI1004	187	
BOR1000 / 250 BK	18	
BRA001RB	108	
BRA1000	164	
BRAJ013M / BRAR013M	118	
BRB300 / 500 / 502	165	
BSA100	182 / 242 / 243	
BSA1003 / 1004	187	
BSA1202	186 / 242	
BSA1202RB	173	
BSA2101RB	178 / 186	
BSF100 / 150	183	
BSP100	183	
BTC / BT 40	138 / 139	
BUT1200	46	
BUT800	46	
BUT800GAL	47	
<b>C</b>		
CA	273	
CA3COMSB	256	
CA60N	273	
CAD203NP	256	
CAD301 / 401 SB / NP	256	
CAD501NP	256	
CAD701GSB	256	
CADSTOP	256	
CALT	274	
CARSTOP	62	
CAS20TEL	256	
CBAGSB	256	
CBB801SBS	97 / 114 / 175 / 198	
CBB820SB	175	
CBF / NF / RF 004SB	175	
CBO / NO / RO 004SB	175	
CBR101SBS	175	
CBR601SBS	175	
CBR610FAB	175	
CBR625NP	175	
CBR6SET	171	
CBR801SBS	97 / 114 / 175 / 198	
CBR805SB	175	
CBR810SB	175	
CBR820NP	175	
CBRSET / EXT	171 / 244	
CBV801SBS	97 / 114 / 175 / 198	
CBV820SB	175	
CDCH25SB	188	
CDCH252SB	232 / 238	
CDGO252SB	238	
CDI236NB	188	
CDN252SB	232 / 238	
CFLUO825SBS	114 / 175 / 198	
CI2	232 / 236	
CL4COMSB/NP	256	
CMLRB806NB	175	
CMLRB825SBS	175	
CNJ101SBS	175	
CNJ601SBS	175	
CNJ610FAB	175	
CNJ625FAB	175	
CNJ801SBS	97 / 114 / 175 / 198	
CNJ820NP	175	
CO2 / 3	9 / 10	
CP (ZEBRA100)	86	
CP (ZEBRA65)	86	
CP1002 / 1081	80	
CP1031 / 1071	81	
CP202 / 402	78	
CP450	85	
CP500 / 800 / 1200	83	
CP5040	77	
CPB	76	
CPB702	76	
CPB70T / L	76	
CPB801SBS	114 / 175 / 198	
CPB820NP	175	
CPF80E	188	
CPJ801SBS	175	
CPK800 / 1100	79	
CPN801SBS	114 / 175 / 198	
CPN820FAB	175	
CPO600 / 850 / 1000	82	
CPR801SBS	114 / 175 / 198	
CRF210SB	177	
CRZ / CZL	274	
CSC2201RB	97	
CSC301 / 501 / 751	89	
CSL700	88 / 265	
CSRING5SB	97	
<b>D</b>		
DIN225B / N / NJ / RB SB	188	
DIN225RBSB	189	
DIN233BL / NJ / RB CT	188	
DIN233RBCT	189	
DIN236NB	188	
DL02SB	175	
DODANE	8	
DP / DPE	276	
DPO	277	
DPP	276	
DVD350	175 / 188	
<b>E</b>		
EASYFAST55 / 75	22	
EASYROLL	24	
EASYSPEED55 / 75 CAP	22	
EASYSPEED55 / 75 NJ	22	
EASYTEEL100 / 25 J	26	
EASYTEELENDJ	26	
END55 / 75 N	22	
ENDFAST55 / 75	22	
ENR200OR / RB / NJ	116 / 196	
ENRBOX	117 / 197	
ENRPOST140	117 / 197	
EPB / N / R 804SB	175	
ERB804SB	175	
ESA	272	
ESI502NS	188	
ESN584SB	188 / 238	
ESN584NS	188	
ESR584SB	188	
ESS581CH / GO	238	
ESS582NP	188	
ESW584SB	188	
EXTENSO / JA	111 / 191	
<b>F</b>		
FAR001	118	
FAST2500 / 5000	20	
FAST50 / 70 NJ	21	
FAST60NJ	20	
FASTEND	20	
FASTEND50 / 70 NJ	21	
FASTLED50 / 70 NJ	21	
FLASH101 / 106 OR	118	
FLASH90	96 / 118	
FLEXO200 / EXT	111 / 191	
<b>G</b>		
GPP501	107	
GRI KIT / EXT	185 / 243	
GUI200 / 500	115 / 199	
<b>H</b>		
HD700	23	
HD7025 / 7050	23	
HDEND700	23	
HERSE1000 / END	26	
<b>I</b>		
ILO	17	
ILO300	16	
ILO4025	17	
ISO800 / 1300	253	
<b>K</b>		
KOB6 / 8	10	
<b>L</b>		
LA60N	273	
LAMPBRA	164	
LAMP SOL	118	
LAMP SOL180	118	
LAPDP	272	
LOCAR / LOCAM	61	
LP	277	
LPC38	277	
LPR	277	
<b>M</b>		
M4161 / 5177	65 / 260	
M450 / 600 / 800	65 / 260	
MAN602NS	188	
MD45 / 60 / 80 RB	64	
MDI602NS	188	
MH69 / 129 / 99	64	
MIROIR	65 / 261	
MR3054 / 5684 RB	64	
MRA602NS	188	
MRAN604SB	188	
MRAR604SB	188	
MRB1004SBS	175	
MRB604S / 804 SB	175	
MRI602NS	188	
MRN1004SBS	175	
MRN604 / 804 SB	175	
MRP602 / 802 NP	175	
MRR1004SBS	175	
MRR604 / 804 SB	175	
MS90 / 180 / 360	261	

<b>N</b>			
NAU64NB	188		
NDM900 / 1300	39 / 201 / 268		
<b>P</b>			
PALU	275		
PAO300	278		
PARK	45 / 144		
PARKORNER	45 / 145		
PARKSTEEL	45 / 145		
PARKSTOP	41		
PARKLANE	43		
PARKPLACE	42		
PASS	101		
PCS10060NJ	142		
PCS4050RO	142		
PDM900 / 1300	39 / 201 / 268		
PEL1023 / 1523	253		
PFER520SB	107 / 198		
PNAE300	278		
PNUR300S	278		
PNX	34 / 35		
PNX-5070-CHARIOT	165		
POD104	36		
POD25 / 35	37		
POD29LIS / RE	36		
POD304 / 316 INOX	37 / 164		
POD42 / 81	37		
POD81ALU	164		
POM01RB	189		
POT1 KIT / EXT	184		
POT / POTS 159316	52 / 147		
POT162V	54 / 67		
POT1616J	149		
POT6 KIT	184		
POTS600GAL	54 / 142		
POT757GAL	54 / 142		
POT76R	54 / 142		
POT / POTS 800	52 / 149		
POT / POTS 89316	52 / 147		
POT90 / 159 / 273	149		
POT90 / 160 LEDRB	148		
POTBOX89 / 159	52 / 147		
POV100 / 150	27		
POW01RB / POW02	189		
PPC1 KIT / EXT	244		
PPC1001 / 3001	170		
PPC2001	173		
PPC3002	171		
PPC3006	171		
PPC3EXT	171		
PPC / PPK 40	170		
PPC500 / LO	173		
PPCA4	174 / 249		
PPC / PPK EXT	171		
PPC-FIX	172		
PPC / PPK SET40	171		
PPC / PPK SET406	171		
PPE1002 / 2100 / 6100 RB	174		
PPLO / PPVD 100	172		
PR-5070	34 / 35		
PRF700	143		
PSG501	265		
PSG680	263		
PSG700	264		
PSR100 / 103	27		
PSTAT	34		
PU	155		
PU102 / 352 / 1502	161		
PU15080	160		
PU208 / 502 / 702	157		
PU30	159		
PU3030	159		
PU3060 / 5080 NJ	157		
PU3515 / 3540	160		
PU4015 / 7325	158		
PU4025 / 10025 / 150025	158		
PU5020	160		
PUC500	160		
PUS300	159		
PUX401 / 1001 / 1500	156		
<b>R</b>			
RAMP125 / 178	103 / 258		
RB300 / 500 / 500TPU	165		
RC101 / 106 FLASH	96		
RC300 / 500 / 752 / 1000	89		
RCBAR215RB	177		
RCBAR215	97		
RCBASELO / VD	95		
RCBOX	94		
RCLAMPSOL180	96		
RCPNXA4 / A3	95		
RCTROLLEY	96		
RCX	92 / 93		
RECO2 / 22	226		
RECOA3P / A4P	227		
REDO4	226		
REF100SBS	27		
REF140LED	27		
REF501SBS / BASE	27		
REWO20	227		
REXO100	234		
REXO22 / 2	235		
REXO3 / 4 PN / ALU / G	234 / 239		
REXO 3 / 4	249		
REXO60	237		
REXOBACH1 / 2	239		
REXOCHAIN	238		
REXO H / V	251		
REXURN300 / 400	250		
REZO100	237		
REZO150	232 / 236		
RMU500 / 850	231		
RMUA3 / A4	231		
ROAD	107		
RQ1000	162		
RQ836 / 800	162		
RQDB100 / 150 / 200	166		
RQP / RQR 114 NJ	163		
RR / RRD	15 / 99		
RR1280 / 1612	102		
RR1400 / 1700 / 2060	100		
RS2 / 4 / 410	212		
RS / F / LO / P / B 160	220		
RS4BAR	241		
RS4PNX	241		
RS4RING	241		
RSA335 / 550 / 5100	200 / 267		
RSA2 / A3 / A4 / ROT	221		
RSA3 / A4	188		
RSA3 / A4 G	221		
RSA3 / A4 PN	188 / 221		
RSB	213		
RSF	213		
RSLO	214		
RSNA	114 / 198		
RSNT100	200 / 267		
RSP4 / 410	214		
RSR	214		
RSU	212		
RTU815 / 820 NJ	163		
RW	215		
RWSMART	230		
RWX	219		
RX	216		
RXB	217		
RXF	217		
RXLO	218		
RXP	218		
RXR	218		
RXU2	216		
<b>S</b>			
S	275		
SAFETY / SCUP	25 / 85		
SAFETY / SCUP 100	85		
SAN500	203 / 270		
SAS150 / 315	138		
SCOOTER7	68		
SEP70 / 120	16		
SL420 / 620 SB	231		
SLOBUMP	24		
SLOEND	24		
SMART55 / 85	230 / 232		
SOL350 / 500	203 / 270		
SOLEX	63 / 202 / 269		
SP1205SB	107 / 198		
SPEED50 / 70	20		
SPEND50 / 70	20		
SQ818	162		
SSC310 / 370	88		
STICK	95 / 272		
STOPBLOCK	59		
STOPCAR	57		
STOPCRASH	60		
STOPFRAME	59		
STOPOST	57		
STOPRO	58		
STOPSOL	61		
STOPUSH	60		
STOPWHEEL	58		
SWP2 / 3 / 4	246		
SWP2 / 3 / 4 FIX	248		
SWP2 / 3 / 4 ROT	247		
SWPO2 / 3 / 4	248		
<b>T</b>			
TAH	18		
TP167N	33		
TPA660 / 810	29		
TPANTIQUE	33		
TPBOX80 / 100	30 / 32 / 33 / 152 / 153		
TPU	32 / 33		
TPU / TPZ RING	33 / 152 / 153		
TPUTAPE	33		
TPX1235 / 1275 / 12100 NJ	151		
TPX140 / 160 / 270 NJ	153		
TPX40 / 60 NJ	153		
TPX710 / 810 / 1110	153		
TPX800 / 1200 / 2000 NJ	42 / 151		
TPX808 / 1108 / 1008	152		
TPY	33		
TPZ	31		
TPZ1280P	31 / 33		
TRAVO	120 / 121		
TRAVO100	122 / 123		
TRAVO128	124 / 125		
TRAVO180	126 / 127		
TRAVO228	128 / 129		
TRIAK	106		
TRIANG	62		
TRIFAU	106		
TRIGEO	106		
TROLLEY6 / 9 / EXT	223		
<b>U</b>			
URN250 / 750	255		
URN300 / 400	255		
URNOF600 / 1200	254		
<b>V</b>			
VELO1	66		
VELO4 / 6 / 8 / 42 / 52	69		
VELO5	67		
VELO755GAL	67		
VELORACK	66		
VELORING	68		
VELOSTAND	67		
VELOSTORE	66		
VJXL / VRXL	118		
<b>W</b>			
WALL1200	63 / 204		
WARN1200	63 / 204		
WH501SB	193		
WHEELPARK	62		
WHEELSTOP	62		
WHEELTRUCK	62		
WP100 / 170 / 240	84		
WR10SB	222		
WR24SB	227		
WR6SB	222 / 227		
WRADSB	222		
WRE100CONNECT	222		
WRESB / 100SB	222		
WRECONNECTSB	222		
<b>Z</b>			
ZE	14		
ZE100 / 25	15 / 99		
ZEBRA100	12 / 86		
ZEBRA100PAP	13		
ZEBRA65	11 / 86		



**A**

ADAPTATEUR UNIVERSEL	222
ADHESIF POUR MARQUAGE AU SOL EXTERIEUR	63-202-269
ADHESIF POUR MARQUAGE AU SOL INTERIEUR	203-270
ARCEAU DE PARKING A MÉMOIRE DE FORME	60
ARCEAU DE PARKING AUTOMATIQUE	61
ARCEAU DE PARKING AVEC CADENAS	57
ARCEAU DE PARKING AVEC CYLINDRE	58-59
ARCEAU DE PARKING AVEC RESSORTS	60
ARCEAUX ANTI -ENCASTREMENT	140
ARCEAUX FLEXIBLES A MÉMOIRE DE FORME	150-151
ARCEAUX HAUTE RESISTANCE	141
ATTACHE MURALE	236-238

**B**

BALISE DE RUE	88-265
BALISE FLEXIBLE	29
BALISE HAUTE VISIBILITE	176
BANDE DE GUIDAGE	36
BANDEAU DE SIGNALISATION TISSU	115-199
BARRES EXTENSIBLES POUR CONE	97
BARRICADE	173
BARRIERE A FIXER	56-134-135
BARRIERE A SCELLER	54-136
BARRIERE AVEC ENROULEUR	116-196
BARRIERE DE CHANTIER	107
BARRIERE DE POLICE ACIER	49
BARRIERE DE REGARD	108
BARRIERE EXTENSIBLE ACIER	108-109-192-193
BARRIERE EXTENSIBLE PLASTIQUE	111-191
BARRIERE MODULAIRE	138-139
BARRIERE PARAVENT	120-121-122-123-124-125-126-127-128-129-195
BARRIERE POLYPROPYLENE	50-51-112-113
BASE POUR BARRIERE POLYPROPYLENE	50-112
BASE POUR CONE	95
BORDURE DE BALISAGE	43
BORDURE DE DELIMITATION D'ILOTS	18
BUTEE ACIER POIDS LOURD	47
BUTEE DE PARKING	41
BUTEE DE PARKING HAUTE VISIBILITE	42
BUTEE DE PROTECTION	144-145
BUTEE DE PROTECTION ACIER	45
BUTEE FLEXIBLE A MÉMOIRE DE FORME	42
BUTEE POIDS LOURD ET CHARIOT ELEVATEUR	46
BUTEES FLEXIBLES A MÉMOIRE DE FORME	151
BUTOIR (MOUSSE)	160

**C**

CADENAS	256
CALE ROUE POUR VOITURE ET POIDS LOURDS	62
CASIER POUR EFFET PERSONNELS	256
CHAINE ACIER	188-232-238
CHAINE POLYPROPYLENE	97-114-175-198
CHARIOT POUR CONE	96
CHARIOT TRANSPORT POTEAUX	223
CHEVALET	263-264
CHIFFRE AUTOCOLLANT	273
CHIFFRES DE RUE	274
CHIFFRES ET LETTRES ADHÉSIFS	273
CLOU PODOTACTILE	37
CLOUS DE VOIRIE	27
COFFRE RANGEMENT POUR BARRIERE AVEC ENROULEUR	117-197
COLLE	281
COLLECTEUR DE PILES ET CARTOUCHES	256
CONE AVEC SANGLE	90-91-92-93
CONE DE SIGNALISATION PLIANT	88

CONE LESTE	89
CONE REFLECHISSANT CLASSE I	89
CÔNE SOL GLISSANT PARAPLUIE	265
CONNECTEUR DE SANGLE	222
CORDE	237
CORDE ELASTIQUE	231
CORDE TRESSEE	232-236
CORDE VELOURS	232-236
COUSSIN BERLINOIS	9-10
COUSSIN DE RALENTISSEMENT	25
COUVERTURES DE TRANCHEES	102
CROCHET PLASTIQUE	175

**D**

DOS D'ANE	8
-----------	---

**E**

EMBASES	55-137
ENROULEUR MURAL	227
ENROULEUR MURAL (EXTERIEUR)	219
ENROULEUR MURAL (INTERIEUR)	215
ENROULEUR MURAL (SMART)	230
ENROULEURS UNIVERSELS POUR CONE	94
EPINGLE A VELO	68
ESSE ACIER	188-238
ESSE PLASTIQUE	175
ETRIERS ET PROTECTIONS DE COLONNE	142

**F**

FARDIER	118
FIXATION ASPHALTE	281
FIXATION AUTOUR D'UN POTEAU	222
FIXATION BÉTON	280
FIXATION UNIVERSELLE	280

**G**

GRILLAGE	107
GUIDE ROUE POIDS LOURD	47

**H**

H DE LIAISON	281
HERSE	26

**I**

ISOLOIRS	253
----------	-----

**K**

KIT BACHE / BALISE HAUTE VISIBILITE	179
KIT BACHE IMPRIMEE	239
KIT BARRE EXTENSIBLE / BALISE HAUTE VISIBILITE	177
KIT BARRIERE EXTENSIBLE / BALISE HAUTE VISIBILITE	178
KIT CHAINE / BALISE HAUTE VISIBILITE	177
KIT DE GUIDAGE AVEC CHAINE	238
KIT DE GUIDAGE AVEC CORDE	235
KIT DE GUIDAGE PLASTIQUE	244
KIT FIXATION MAGNÉTIQUE	222-227
KIT POTEAUX AVEC BARRIÈRES	242
KIT POTEAUX AVEC PANNEAU PERSONNALISÉ	241
KIT POTEAUX BARRIERE POSE LIBRE	186
KIT POTEAUX CHAINE ACIER	184
KIT POTEAUX GRILLE POSE LIBRE	185-243
KIT POTEAUX PLASTIQUE CHAINE	171

**L**

LAMPES LED CHANTIER	118
LAMPES LED POUR CONE	96

**M**

MAILLE PLASTIQUE	175
MAILLON A VISSER ACIER	188
MAILLON A VISSER PLASTIQUE	175
MANILLE DROITE ACIER	188
MIROIR D'AGGLOMERATION	64
MIROIR DE SECURITE	65-260-261

**N**

NEZ DE MARCHE	39-201-268
---------------	------------

**P**

PANNEAU ADHÉSIF	275-276-277
PANNEAU AFFICHAGE LEGAL	278
PANNEAU ALUMINIUM ADHÉSIF	275
PANNEAU SOLAIRE A LED	34-35-106
PANNEAUX ELECTORAUX	253
PASSAGE PIETONS	13
PASSE CABLE CHANTIER	84
PASSE CABLE DE BUREAU	76
PASSE CABLE ET TUYAUX POIDS LOURD	82-83
PASSE CABLE GRANDE LONGUEUR	85
PASSE CABLE PIETON	77
PASSE CABLE SERIE 1000	80-81
PASSE CABLE TRANSPORTABLE PLIANT	79
PASSE CABLE TRAVERSEE DE ROUTE	85-86
PASSE CABLES MODULAIRE	78
PASSERELLE	101
PIQUET DE CHANTIER	107
PLAQUE DE CHAUSSEE	100
PLAT DE MARCHE	39-201-268
PLATEAU	11-12
PLOT RALENTISSEUR	17
PORTE AFFICHE	175-188-221-234
PORTE AFFICHE POUR CONE	95
PORTE AFFICHE POUR POTEAU A SANGLE (BUDGET)	227
POTEAU ACIER	52
POTEAU ACIER A FIXER	183
POTEAU ACIER REPLIABLE	183
POTEAU DE BALISAGE A PLANTER	172
POTEAU DE BALISAGE BASE LOURDE	172
POTEAU DE BALISAGE PLIANT	173
POTEAU DE DELIMITATION POUR CORDE ELASTIQUE	231
POTEAU DE DELIMITATION POUR CORDE ET CHAINE (REXO)	234
POTEAU DE DELIMITATION POUR CORDE ET CHAINE (SMART)	232
POTEAU DE GUIDAGE A SANGLE (INTERIEUR)	212-213-214
POTEAU DE GUIDAGE A SANGLE (BUDGET)	226
POTEAU DE GUIDAGE A SANGLE (EXTERIEUR)	216-217-218
POTEAU DE GUIDAGE A SANGLE (SMART)	230
POTEAU DE PARKING RABATTABLE	57
POTEAU D'INFORMATION	220
POTEAU D'INFORMATION (ACIER)	187
POTEAU D'INFORMATION (PLASTIQUE)	174-249
POTEAU EMPILABLE ACIER	187
POTEAU PLASTIQUE BUDGET	174
POTEAU POUR CORDE FILANTE	237
POTEAU SUPPORT / RECEPTEUR POUR BARRIERE AVEC ENROULEUR	117-197
POTEAU SUPPORT CATALOGUE	251
POTEAUX A LED	148
POTEAUX ACIER	149
POTEAUX ACIER BASE LESTEE	182
POTEAUX ACIER SERIE LOURDE	189

POTEAUX D'INFORMATION - POSITION ET HAUTEUR RÉGLABLES	247
POTEAUX DE BALISAGE PREMIUM	170
POTEAUX D'INFORMATION HAUTEUR AJUSTABLE	246
POTEAUX D'INFORMATION HAUTEUR FIXE	248-249
POTEAUX FLEXIBLES A MÉMOIRE DE FORME	152-153
POTEAUX INOX	52-147
POTELET FLEXIBLE A MÉMOIRE DE FORME	30-31-32-33
PROJECTEUR DE QUAIS	164
PROTECTION D'ANGLE (CAOUTCHOUC)	162-163
PROTECTION D'ARETE (MOUSSE)	157
PROTECTION DE CANALISATION (CAOUTCHOUC)	163
PROTECTION DE MUR (CAOUTCHOUC)	162
PROTECTION DE PROFILE (MOUSSE)	156
PROTECTION DE QUAIS	165
PROTECTION DE TUBES ET TUYAUX (MOUSSE)	157
PROTECTION DE VOIRIE	164
PROTECTION HAUTE RESISTANCE	166
PROTECTIONS D'ANGLE	143
PROTECTIONS D'ANGLE (MOUSSE)	158-159
PROTECTIONS DROITES (MOUSSE)	160-161

**R**

RACK A TROTTINETTE	68
RACK A VELO	66-67-69
RALENTISSEUR	14-24
RALENTISSEUR	20-21-22
RALENTISSEUR ACIER	26
RALENTISSEUR POIDS LOURD	23
RALENTISSEUR TRANSPORTABLE	24
RAMPE D'ACCÈS TRANSPORTABLE	258
RAMPE D'ACCÈS TRANSPORTABLE	103
RAMPE DE PORTAIL	63-204
RAMPES	15-99
RÉCEPTEUR MURAL DE SANGLE	222-227
REFLECTEURS LUMINEUX	27
ROND POINT	16
RUBAN DE BALISAGE	200-267
RUBAN DE SIGNALISATION	114-198

**S**

SABOT ANTIVOL	61
SEPARATEUR DE VOIES FRANCHISSABLE	16
SIGNALÉTIQUE ADHÉSIVE	272
SIGNALÉTIQUE ADHÉSIVE TRANSPARENTE	272
SIGNALISATION DE VIRAGE	63-204
STICKERS POUR CONE	95
STRUCTURE AUTOPORTANTE POUR ARCEAU DE PARKING	59

**T**

TAPIS ANTI HERBE	18
TRIANGLE	62
TRIPODE PLIABLE	106

**U**

URNE SUR POTEAU	250
URNES	255
URNES OFFICIELLES AVEC COMPTEUR	254

**V**

VESTE DE SECURITE	118
-------------------	-----



**A**

ADHESIVE ALUMINUM SIGN	275
ADHESIVE LETTERS AND NUMBERS	273
ADHESIVE SIGNS	272-275-276-277
ANTI-COLLISION BAR	144-145
ASPHALT FIXING	281

**B**

BALLOT BOX	255
BALLOT BOX ON POST	250
BALLOT BOX WITH COUNTER	254
BARRIERS TO EMBED	54-136
BARRIERS TO FIX	56-134-135
BASE FOR CONES	95
BASE FOR PP BARRIERS	50-112
BATTERIES AND CARTRIDGES COLLECTOR	256
BELT CONNECTOR	222
BELT WALL RECEIVER	222
BICYCLE RACK	66-67-69
BLACK CUSTOMIZABLE CONE	88-265
BRAIDED ROPE	232-236
BROCHURE HOLDER POST	251
BUDGET PLASTIC POST	174
BUMPER	160

**C**

CABLE BRIDGE SERIE 1000	80-81
CAR AND TRUCK WHEEL CHOCK	62
CIRCULAR SPEED BUMP	17
COLUMN AND PIPE PROTECTORS	142
CONCRETE FIXING	280
CONE WITH RETRACTABLE BELT	90-91-92-93
CONES TROLLEY	96
CORNER FOAM PROTECTOR	158-159
CORNER PROTECTION GUARDS	143
CORNER RUBBER PROTECTION	162-163
CROWD CONTROL BARRIER	49

**D**

DOCK LED LIGHT	164
DOCKS BUMPERS	165

**E**

EDGE FOAM PROTECTOR	157
ELASTIC CORD	231
ELECTION POSTER BOARD	253
EXPANDABLE / RETRACTABLE FABRIC BARRIER	116-196
EXPANDABLE PLASTIC BARRIER	111-191
EXPANDABLE STEEL BARRIER	108-109-192-193
EXPANDING BARRIERS FOR CONES	97
EXTRA LONG CABLE BRIDGE	85

**F**

FENCE	107
FIXATION AROUND A POST	222
FIXING AND RECEIVER POST FOR RETRACTABLE FABRIC BARRIER	117-197
FLEXIBLE BOLLARD	29
FLEXIBLE BOLLARD FOR INDUSTRY	152-153
FLEXIBLE BOLLARD WITH SHAPE MEMORY	30-31-32-33
FLEXIBLE HOOP	150-151
FLEXIBLE PARKING HOOP	60
FLEXIBLE PROTECTION BARS	42-151
FLOOR CABLE COVER	76
FLOOR SIGN	263-264
FOLDABLE CABLE PROTECTOR	79

FOLDABLE PLASTIC SIGNPOST	173
FOLDABLE REFLECTIVE CONE	88
FOLDABLE STEEL POST	183
FOLDABLE TRIPOD	106
FOLDING PARKING POST	57
FOOTBRIDGE	101

**G**

GATE RAMP	63-204
GLASS AND SOLAR ROAD STUD	27
GLUE	281
GRASS PROTECTION PLATE	18
GROUND PROTECTION	164
GUIDING POST FOR ELASTIC CORD	231
GUIDING POST WITH CHAIN	238
GUIDING POST WITH CHAIN OR ROPE (REXO)	234
GUIDING POST WITH CHAIN OR ROPE (SMART)	232

**H**

H LINK	281
HEAVY DUTY BUMPERS	166
HEAVY DUTY CONE	89
HEAVY DUTY PARKING HOOP WITH SPRINGS	60
HEAVY DUTY PROTECTION GUARDS	141
HEAVY DUTY SPEED BUMP	23
HEAVY DUTY STEEL POST	189
HIGH VISIBILITY BOLLARD	176
HIGH VISIBILITY BOLLARD CHAIN KIT	177
HIGH VISIBILITY BOLLARD EXPANDABLE BARRIER KIT	177-178
HIGH VISIBILITY BOLLARD TARPULIN KIT	179
HIGH VISIBILITY PROTECTION GUARD	42
HIGH VISIBILITY WARNING STRIP	115-199
HOOP PROTECTION GUARD WITH PLATE	140
HOSE AND CABLE BRIDGE	82-83

**I**

INDOOR WARNING FLOOR STICKER	203-270
INFORMATION PLASTIC POST	174-249
INFORMATION POST	220
INFORMATION POST - ADJUSTABLE HEIGHT	246
INFORMATION POST - ADJUSTABLE POSITION AND HEIGHT	247
INFORMATION POST - FIXED HEIGHT	248-249
INFORMATION STEEL POST	187

**L**

LED STEEL POSTS	148
LED WARNING CONE LIGHT	96
LED WARNING LIGHT	118
LEGAL MENTION SIGN	278
LOCKER FOR PERSONAL BELONGINGS	256

**M**

MAGNETIC MOUNTING KIT	222-227
MARKING TAPE	200-267
MODULAR BARRIER	138-139
MODULAR CABLE PROTECTOR	78

**N**

NON-SLIP STAIR NOSING	39-201-268
-----------------------	------------

**O**

OUTDOOR WARNING FLOOR STICKER	63-202-269
-------------------------------	------------

**P**

PADLOCK	256
PARKING HOOP FRAME	59
PARKING HOOP WITH KEY	58-59
PARKING HOOP WITH PADLOCK	57
PARKING RAMP SIGN	63-204
PEDESTRIAN CABLE COVER	77
PIPE FOAM PROTECTOR	157
PIPE RUBBER PROTECTOR	163
PLASTIC «S» SHAPE HOOK	175
PLASTIC HOOK	175
PLASTIC POST & CHAIN KIT	171-244
PLASTIC QUICK LINK	175
PLASTIC SIGNPOST	170
PLASTIC SIGNPOST WITH HEAVY BASE	172
PLASTIC SIGNPOST WITH STAKE	172
POLYPROPYLENE BARRIERS	50-51-112-113
POLYPROPYLENE CHAIN	97-114-175-198
POP UP WET FLOOR SIGN	265
POST & BARRIERS KIT	173
POST FOR ROPE	237
POST TROLLEY	223
POSTS AND CUSTOMIZED PANEL	241
POSTS AND CUSTOMIZED TARPAULIN	239
POSTS WITH ROPE SET	235

**R**

RACK FOAM PROTECTOR	156
RAMPS	15-99
REFLECTIVE WORKSITE POSTS	107
RETRACTABLE BELT STANCHION (BUDGET)	226
RETRACTABLE BELT STANCHION (INDOOR)	212-213-214
RETRACTABLE BELT STANCHION (OUTDOOR)	216-217-218
RETRACTABLE BELT STANCHION (SMART)	230
ROAD CROSSING CABLE BRIDGE	85-86
ROAD PLATE	100
ROPE	237
ROUND ABOUT	16
RUBBER BORDER	18
RUBBER PARKING STOP	41

**S**

SAFETY MIRRORS	64-65-260-261
SAFETY VEST	118
SCOOTER RACK	68
SCREEN PROTECTION BARRIER	120-121-122-123-124-125-126-127-128-129-194-195
SELF-ADHESIVE NUMBER	273
SIGN HOLDER	188-221
SIGN HOLDER	234
SIGN HOLDER FOR BUDGET BELT STANCHION	227
SIGN HOLDER FOR CONES	95
SOCKETS FOR BARRIERS	55-137
SOLAR LED TRAFFIC SIGN	34-35-106
SOLAR PARKING HOOP	61
SPEED BUMP	20-21-22-25
SPEED CUSHION	9-10-11
SPEED RAMP	14-24
SPEED TABLE	8-12
SQUARE EXPANDABLE BARRIER	108
STACKABLE STEEL POST	187
STAINLESS STEEL POSTS	52-147
STAIRS PAD	39-201-268
STEEL «S» SHAPE HOOK	188-238
STEEL CHAIN	188-232-238
STEEL POST & BARRIERS KIT	186-242

STEEL POST & CHAIN KIT	184
STEEL POST & FENCE KIT	185-243
STEEL POST TO FIX	183
STEEL POST WITH LOADED BASE	182
STEEL POSTS	52-149
STEEL PROTECTION BAR	45
STEEL QUICK LINK	188
STEEL ROAD STUD	27
STEEL SHACKLE	188
STEEL SPEED BUMP	26
STEEL TRUCK BUMPER	47
STICKERS FOR CONES	95
STORAGE BOX FOR RETRACTABLE FABRIC BARRIER	117-197
STREET NUMBERS	274

**T**

TACTILE GUIDE STRIPS	36
TACTILE STUDS	37
TIRE KILLER	26
TRAFFIC CONE	89
TRAFFIC DIVIDER	16
TRANSPARENT ADHESIVE SIGNS	272
TRANSPORTABLE ACCESS RAMP	103-258
TRANSPORTABLE SPEED RAMP	24
TRENCH COVER PLATE	102
TRUCK AND FORKLIFT BUMPER	46
TRUCK WHEEL GUIDES	47

**U**

UNIVERSAL ADAPTER	222
UNIVERSAL FIXING	280
UNIVERSAL RETRACTABLE BARRIER FOR CONES	94
U-SHAPED BIKE RACK	68

**V**

VELVET ROPE	232-236
VOTING BOOTH	253

**W**

WALL FOAM PROTECTOR	160-161
WALL MOUNTED BARRIER (BUDGET)	227
WALL MOUNTED BARRIER (INDOOR)	215
WALL MOUNTED BARRIER (OUTDOOR)	219
WALL MOUNTED BARRIER (SMART)	230
WALL RECEIVER FOR ROPE & CHAIN	236-238
WALL RUBBER PROTECTOR	162
WARNING BORDER	43
WARNING TAPE	114-198
WARNING TRIANGLE	62
WHEEL BLOCKING SYSTEM	61
WORKSITE BARRIER	107
WORKSITE CABLE PROTECTOR	84

**Z**

ZEBRA CROSSING	13
----------------	----





A series of horizontal lines for writing, starting from the top line and extending down to the bottom of the page.



A series of horizontal lines for writing, starting from the top line and extending down to the bottom of the page.





A series of horizontal lines for writing notes, starting from the top of the page and extending downwards.

# Créa Luxe.fr

Crealuxe SARL BP 4003584101 Orange CEDEX

04.84.71.54.42

serviceclient@crealuxe.fr

