

## Protections industrielles

Industrial protections

## BARRIÈRES ◦ BARRIERS

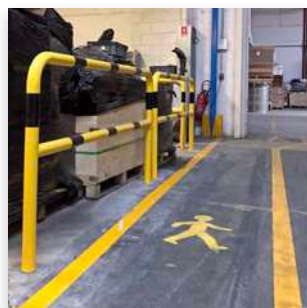

## ARCEAUX ET ÉTRIERS ◦ HOOPS AND PROTECTIONS

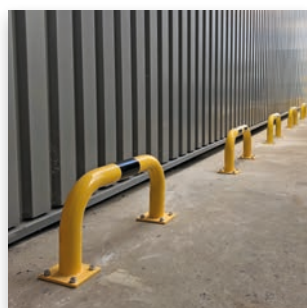

## BUTÉES ◦ BARS



## POTEAUX ◦ POSTS



## PROTECTIONS À MÉMOIRE DE FORME ◦ FLEXIBLE PROTECTIONS

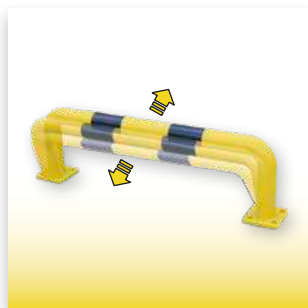

## PROTECTIONS MOUSSE ◦ FOAM PROTECTIONS



## PROTECTIONS CAOUTCHOUC ◦ RUBBER PROTECTIONS

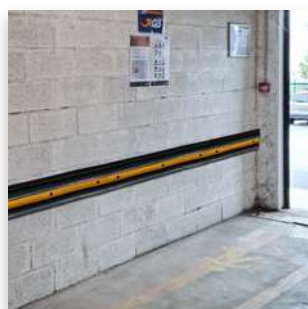

## EQUIPEMENTS DE QUAIS ◦ DOCK EQUIPMENT







# BAR

## BARRIÈRE À FIXER

BARRIERS TO FIX ◦ BARRERA CON BASE ◦ RAMMSCHUTZBÜGEL MIT PLATTE



Code		
BAR 400 RB		6,80
BAR 400 NJ		6,80
BAR 400 J		6,80
BAR 415 RB		8,50
BAR 415 NJ		8,50
BAR 415 J		8,50
BAR 420 RB		9,60
BAR 420 NJ		9,60
BAR 420 J		9,60

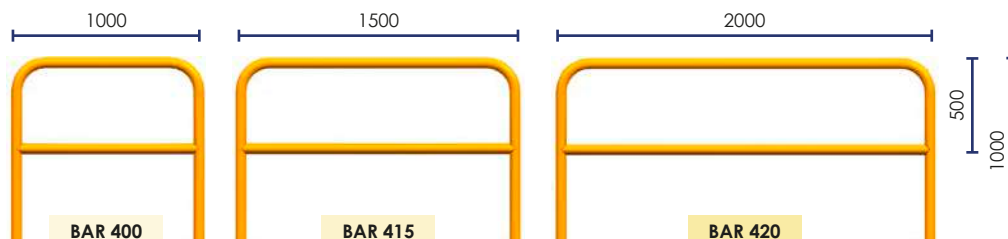
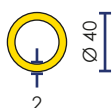

Code	
BAR 400 INOX	6,80
BAR 415 INOX	8,50
BAR 420 INOX	9,60

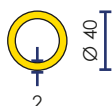

Code	
BAR 400 GAL	6,80
BAR 415 GAL	8,50
BAR 420 GAL	9,60

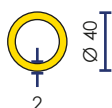

Bords arrondis  
Rounded edges  
Bordes redondeados  
Abgerundete Ecken



Espace limité entre 2  
Limited space between 2  
Espacio limitado entre 2  
Begrenzter Raum zwischen 2

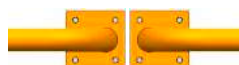

OPTION ◦ OPTIONAL ◦ OPCIÓN ◦ OPTIONAL



BAR FIX 1 SB



BAR FIX 8 SB



BAR FIX 304 SB

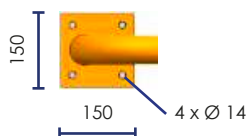

Ne pas installer en milieu salin ou Hydrocarbure. Nous consulter.  
Do not install in saline or Oil environment. Contact us.  
No lo instale en un ambiente salino o hidrocarburo. Consultenos.  
Soll nicht in Salz oder Kohlenstoff Umgebung installiert werden, /uns Konsultieren.

Sauf ◦ Except ◦ Salvo ◦ Nur







BAR

# BARRIÈRE À FIXER

BARRIERS TO FIX ◦ BARRERA CON BASE ◦ RAMMSCHUTZBÜGEL MIT PLATTE



Code	kg
BAR 500 GAL	4,00

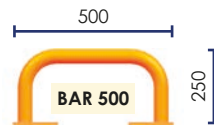
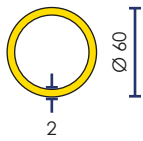

Code	Color	kg
BAR 600 RB	Red/White	9,70
BAR 600 NJ	Black/Yellow	9,70
BAR 600 J	Yellow	9,70
BAR 620 RB	Red/White	13,80
BAR 620 NJ	Black/Yellow	13,80
BAR 620 J	Yellow	13,80

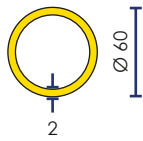

PEINTURE ÉPOXY  
POWDER PAINTING  
PINTURA EPOXICA  
EPOXY FARBE

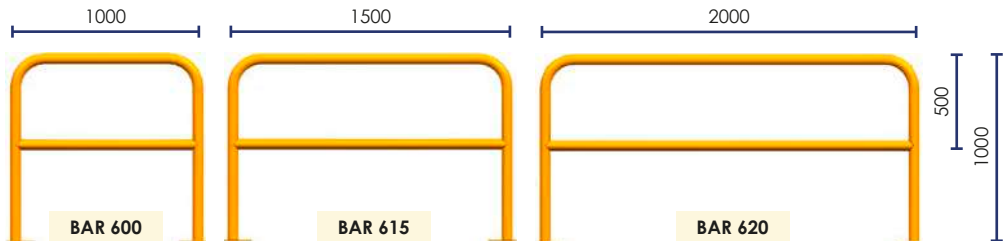

Code	kg
BAR 600 GAL	9,70
BAR 615 GAL	12
BAR 620 GAL	13,8

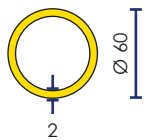

Bords arrondis  
Rounded edges  
Bordes redondeados  
Abgerundete Ecken



Espace limité entre 2  
Limited space between 2  
Espacio limitado entre 2  
Begrenzter Raum zwischen 2

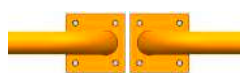

## OPTION ◦ OPTIONAL ◦ OPCIÓN ◦ OPTIONAL



BAR FIX 1 SB



BAR FIX 8 SB



BAR FIX 304 SB

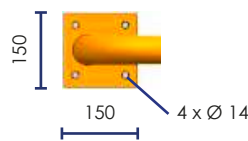

Ne pas installer en milieu salin ou Hydrocarbure. Nous consulter.  
Do not install in saline or Oil environment. Contact us.  
No lo instale en un ambiente salino o hidrocarburo. Consultémos.  
Soll nicht in Salz oder Kohlenstoff Umgebung installiert werden, /uns Konsultieren.

Sauf ◦ Except ◦ Salvo ◦ Nur





**BAS**

**BARRIÈRE À SCELLER** ◦ **BARRIERS TO EMBED**  
**BARRERAS PARA EMPOTRAR** ◦ **RAMMSCHUTZBÜGEL ZUM EINBETONIEREN**

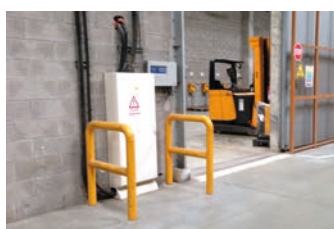

Code		
BAS 405 NJ		4,00
BAS 405 GAL		4,00
BAS 400 NJ		5,00
BAS 400 GAL		5,00
BAS 2930 JA		16,00

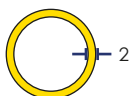
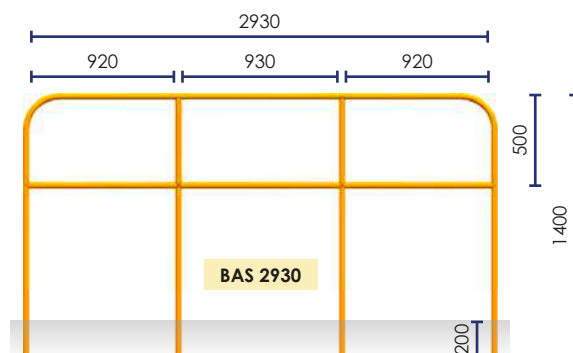
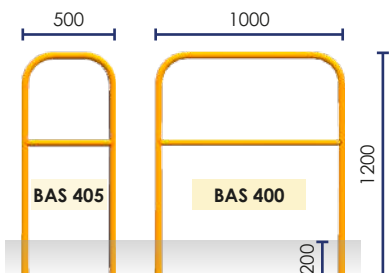

Code		
BAS 600 RB		8,50
BAS 600 NJ		8,50
BAS 600 V		8,50
BAS 600 GAL		8,50
BAS 615 GAL		11,80
BAS 620 RB		12,70
BAS 620 NJ		12,70
BAS 620 J		12,70
BAS 620 GAL		12,70

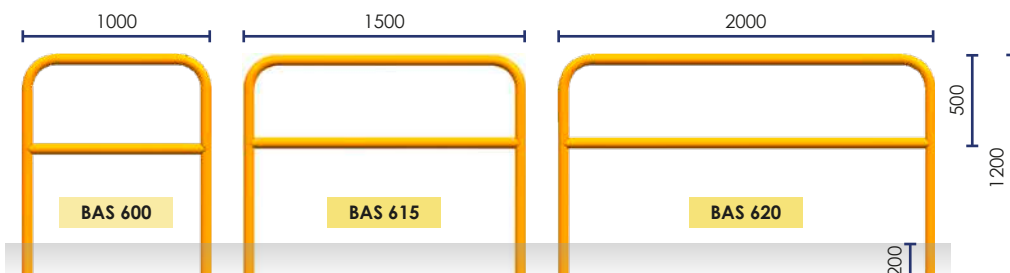

**PEINTURE ÉPOXY**  
**POWDER PAINTING**  
**PINTURA EPOXICA**  
**EPOXY FARBE**



Ne pas installer en milieu salin ou Hydrocarbure. Nous consulter.  
 Do not install in saline or Oil environment. Contact us.  
 No lo instale en un ambiente salino o hidrocarburo. Consúltenos.  
 Soll nicht in Salz oder Kohlenstoff Umgegebung installiert werden,  
 /uns Konsultieren.

Sauf ◦ Except ◦ Salvo ◦ Nur







**BAS**

**BASOL**

**BBASE**

**BAS 40 SIM GAL**

**BAS 40 DOU GAL**

**BAS SIM GAL**

**BAS DOU GAL**

**BAS 60 SIM GAL**

**BAS 60 DOU GAL**

**BAS 60 SIM GAL**

**BAS 60 DOU GAL**

**BASOL 40 GAL**

**BASOL 40 DO GAL**

**BASOL GAL**

**BASOL DO GAL**

**BASOL 60 GAL**

**BASOL 60 DO GAL**

**BASOL 60 GAL**

**BASOL 60 DO GAL**

**BBASE 40**

**BBASE 40 DOU**

**BBASE**

**BBASE DOU**

**BBASE 60**

**BBASE 60 DOU**

**BBASE 60**

**BBASE 60 DOU**



BTC

## BARRIÈRE MODULAIRE

MODULAR BARRIER ◦ BARRERA MODULAR ◦ MODULARE ABSPERRUNGEN



- Les barrières modulaires permettent de disposer d'un équipement adapté et sur-mesure pour assurer la sécurité dans un environnement industriel
- Retrouvez tous nos éléments pour confectionner vous-même vos barrières ou retrouvez des configurations préconçues
- Modular barriers allow you to have the right equipment to ensure the safety on an industrial environment.
- Find all our elements to make your own gates or find pre-designed configurations.
- Las barreras modulares permiten tener el equipo adecuado para garantizar la seguridad en un entorno industrial.
- Encuentre todos nuestros productos para hacer sus propias barreras o consulte las configuraciones prediseñadas.
- Modulare Absperrungen sorgen für eine geeignete Ausstattung und Sicherheit der Industrie.
- Finden Sie alle unsere Elemente, um Ihre Absperrungen selbst zu bauen oder in vordefinierte Konfigurationen zu wählen.

Code	
BTC 40 DE	2,65
BTC 40 AN	3,20
BTC 40 AN 120	3,20
BTC 40 AN 150	3,20
BTC 40 DO	3,21
BTC 40 TR	3,60
BTC 40 POR	6,70
BTC 40 STOP	1,80
BTC 40 BAT	7,40
BT 40 MFL	0,80
BT 40 MML	0,82
BT 40 MFS	0,25
BT 40 MMS	0,30



Code			
SAS 150	Sas acier ◦ Combination Configuración ◦ Kombination	1,5 x 1,5 m	32
SAS 315	Sas acier ◦ Combination Configuración ◦ Kombination	3 x 1,5 m	41



Ne pas installer en milieu salin ou Hydrocarbure. Nous consulter.  
Do not install in saline or Oil environment. Contact us.  
No lo instale en un ambiente salino o hidrocarburo. Consúltenos.  
Soll nicht in Salz oder Kohlenstoff Umgebung installiert werden,  
/uns Konsultieren.



# BARRIÈRE MODULAIRE

MODULAR BARRIER ◦ BARRERA MODULAR ◦ MODULARE ABSPERRUNGEN

Crealluxe.fr

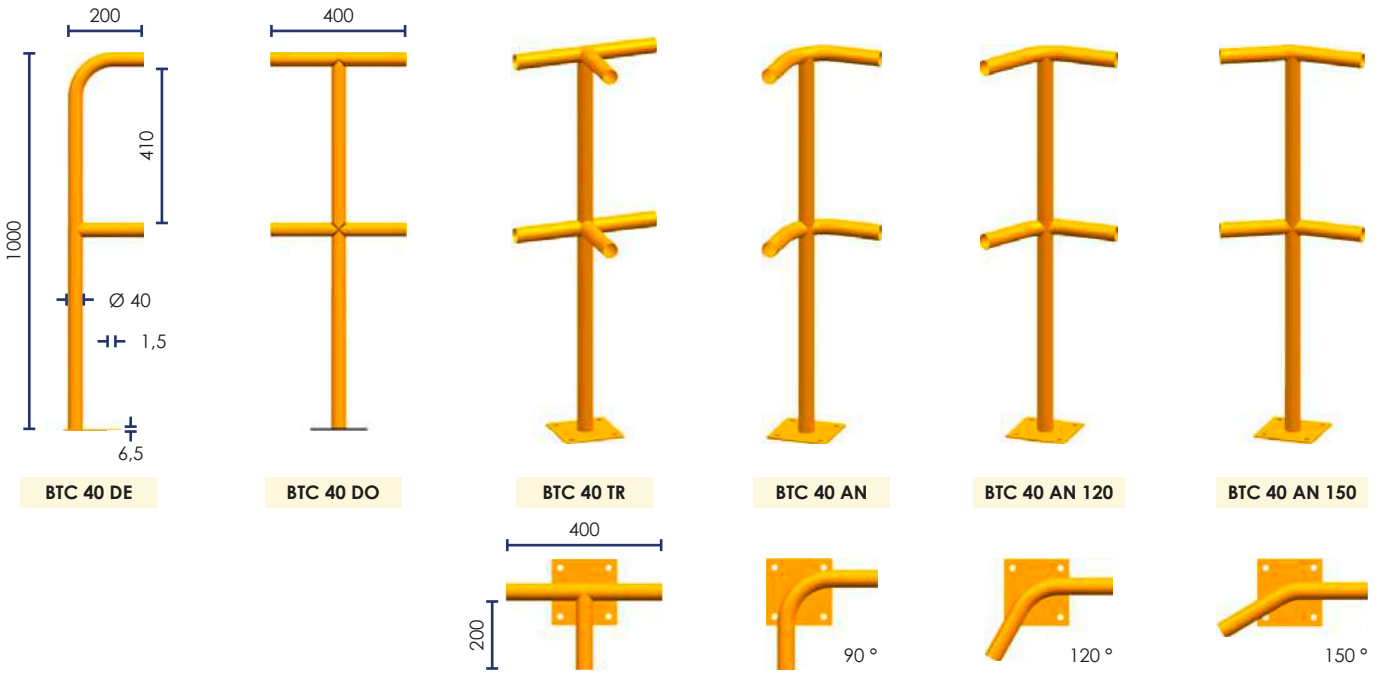

## LONGUEUR ◦ EXTENSIONS ◦ EXTENSIONES ◦ VERLÄNGERUNG

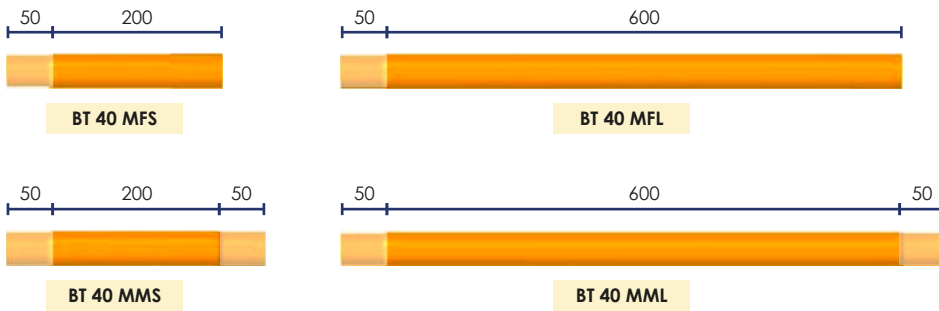

## PORTES ◦ DOORS ◦ PUERTAS ◦ TÜREN

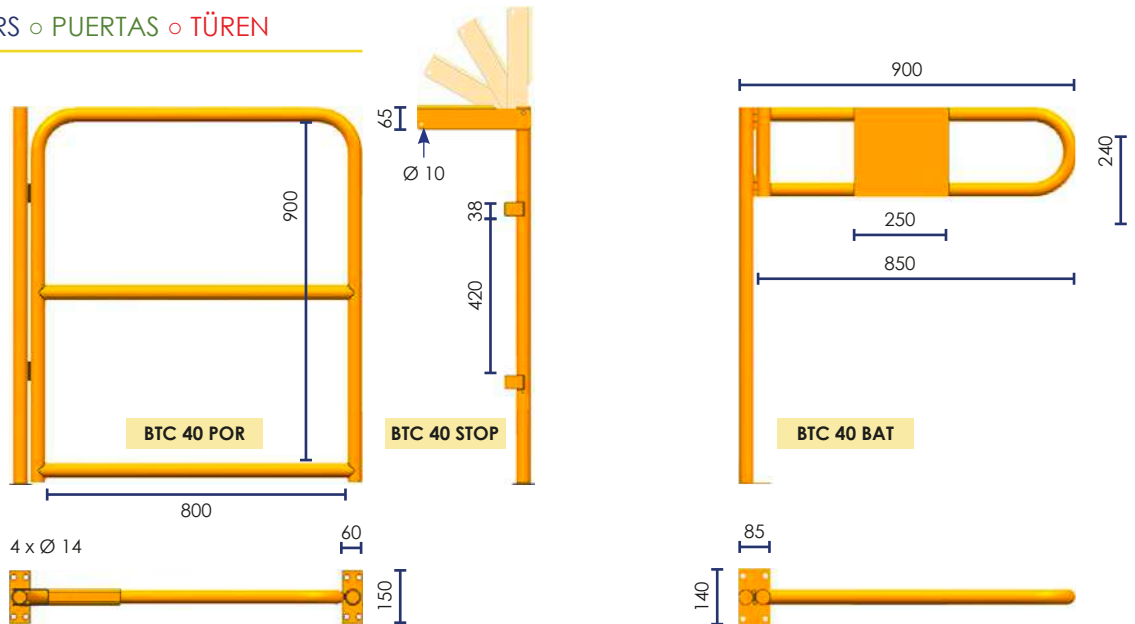

### OPTION ◦ OPTIONAL ◦ OPCIÓN ◦ OPTIONAL

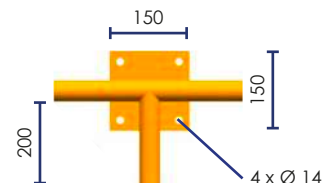



# BARP

## ARCEAU ANTI-ENCASTREMENT HOOP PROTECTION GUARD WITH PLATE ◦ BARRERAS PARAGOLPES SCHUTZBÜGEL MIT HOHEM WIDERSTAND

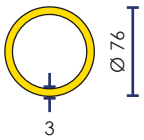

Code		kg
BARP 3575 NJ		9,50
BARP 3510 NJ		11,10
BARP 6075 NJ		13,00
BARP 6010 NJ		15,50

BARP 3575 NJ



BARP 6075 NJ

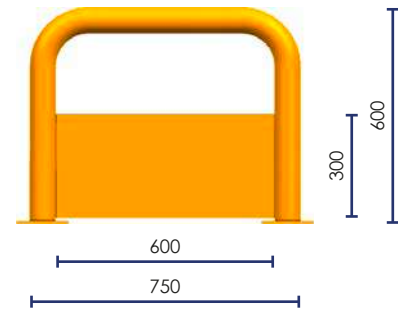

BARP 3510 NJ



BARP 6010 NJ

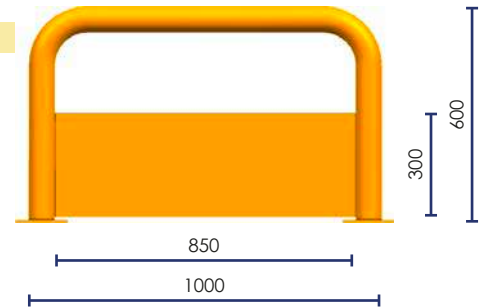

Bords arrondis  
Rounded edges  
Bordes redondeados  
Abgerundete Ecken



### OPTION ◦ OPTIONAL ◦ OPCIÓN ◦ OPTIONAL



BAR FIX 1 SB



BAR FIX 8 SB



BAR FIX 304 SB

160 x 140

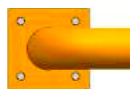

4 x Ø 14



Ne pas installer en milieu salin ou Hydrocarbure.  
Nous consulter.  
Do not install in saline or Oil environment.  
Contact us.  
No lo instale en un ambiente salino o hidrocarburo.  
Consúltenos.  
Soll nicht in Salz oder Kohlenstoff Umgebung  
installiert werden, /uns Konsultieren.





**ARCEAU HAUTE RÉSISTANCE** ◦ **HEAVY DUTY PROTECTION GUARDS**  
**BARRERAS DE PROTECCIÓN ALTA RESISTENCIA**  
**SCHUTZBÜGEL MIT HOHEM WIDERSTAND**

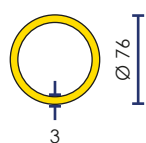

Code		
BAR 37 NJ		6,50
BAR 3575 NJ		7,50
BAR 3510 NJ		9,00
BAR 6075 NJ		10,00
BAR 6010 NJ		11,50
BAR 1275 NJ		15,00
BAR 1210 NJ	16,50	

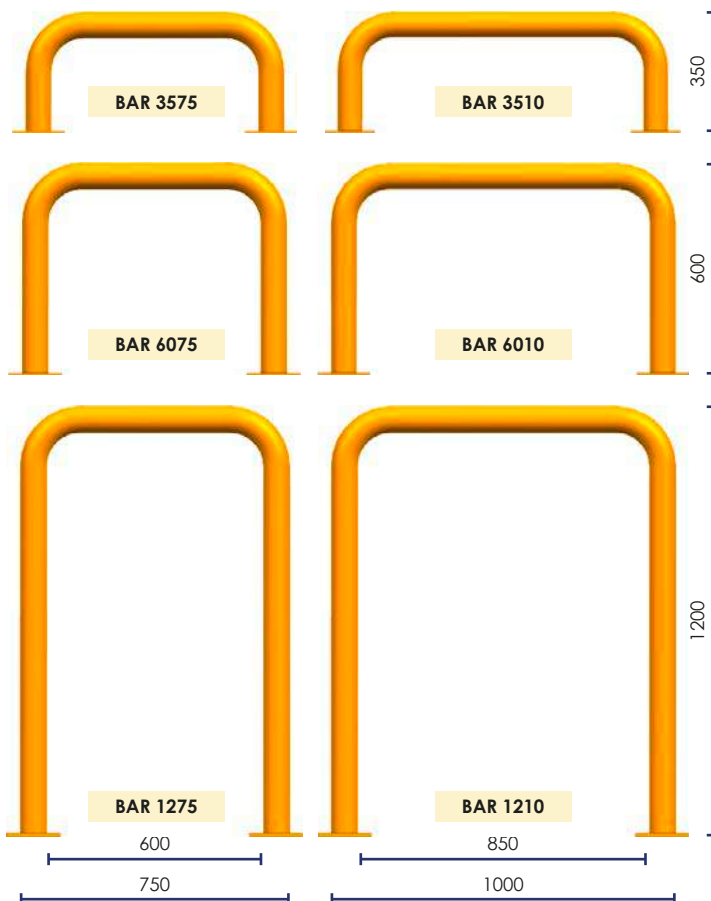
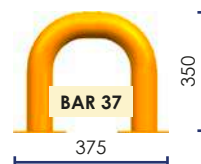

Code			
BAR 37 GAL		6,50	<b>GALVA</b>
BAR 3575 GAL		7,50	
BAR 3510 GAL		9,00	
BAR 6075 GAL		10,00	
BAR 6010 GAL		11,50	
BAR 1275 GAL		15,00	
BAR 1210 GAL	16,50		

Bords arrondis  
 Rounded edges  
 Bordes redondeados  
 Abgerundete Ecken



**OPTION** ◦ **OPTIONAL** ◦ **OPCIÓN** ◦ **OPTIONAL**



BAR FIX 1 SB



BAR FIX 8 SB



BAR FIX 304 SB

160 x 140

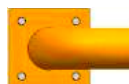

4 x Ø 14



Ne pas installer en milieu salin ou Hydrocarbure. Nous consulter.  
 Do not install in saline or Oil environment. Contact us.  
 No lo instale en un ambiente salino o hidrocarburo. Consúltanos.  
 Soll nicht in Salz oder Kohlenstoff Umgebung installiert werden, /uns Konsultieren.

Sauf ◦ Except ◦ Salvo ◦ Nur





# ÉTRIER ET PROTECTION DE COLONNE

COLUMN AND PIPE PROTECTORS ◦ PROTECCIÓN DE COLUMNAS ◦ SCHUTZBÜGEL

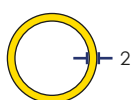

POT 757 GAL

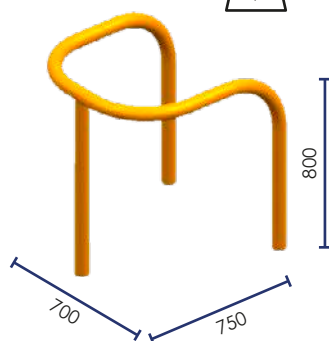

POTS 600 GAL

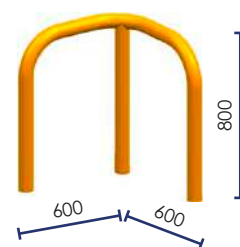

POT 76 R

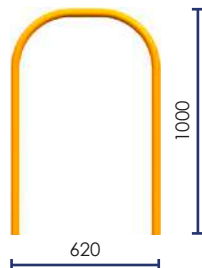

PCS 4050 RO



4 x Ø 14

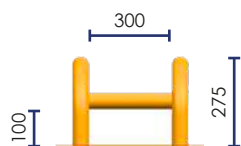
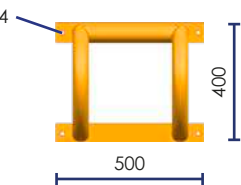

PCS 10060 NJ

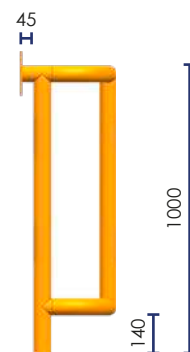

OPTION ◦ OPTIONAL ◦ OPCIÓN ◦ OPTIONAL



BAR FIX 1 SB



BAR FIX 8 SB



BAR FIX 304 SB



PEINTURE ÉPOXY  
POWDER PAINTING  
PINTURA EPOXICA  
EPOXY FARBE





Crealluxe.fr

**BARA**

**PROTECTION D'ANGLE** ◦ **CORNER PROTECTION GUARDS**  
**ESTRIBOS DE PROTECCIÓN** ◦ **SCHUTZBÜGEL**



Ø 76 mm

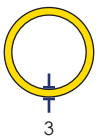

Code		
BARA 3566 NJ		12,00
BARA 6066 NJ		15,20
BARA 1266 NJ		22,80

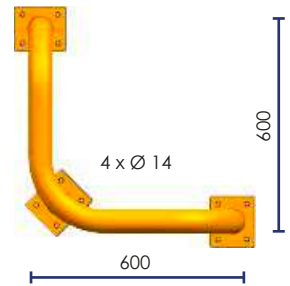

Code		
BARA 3566 GAL		12,00
BARA 6066 GAL		15,20
BARA 1266 GAL		22,80



Code		
PRF 700 NJ		19

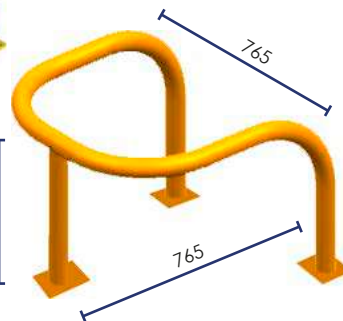

Code		
PRF 700 GAL		19



**OPTION** ◦ **OPTIONAL** ◦ **OPCIÓN** ◦ **OPTIONAL**



BAR FIX 1 SB



BAR FIX 304 SB

160 x 140

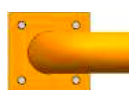

4 x Ø 14



Ne pas installer en milieu salin ou Hydrocarbure. Nous consulter.  
 Do not install in saline or Oil environment. Contact us.  
 No lo instale en un ambiente salino o hidrocarburo. Consultenos.  
 Soll nicht in Salz oder Kohlenstoff Umgebung installiert werden, /uns Konsultieren.

Sauf ◦ Except ◦ Salvo ◦ Nur





# PARK

## BUTÉE DE PROTECTION ANTI-COLLISION BAR BARRA PROTECCIÓN ACERO RAMMSCHUTZBÜGEL-BALKEN



PEINTURE ÉPOXY  
POWDER PAINTING  
PINTURA EPOXICA  
EPOXY FARBE



Code			
PARK 6565 NJ	6		4,80
PARK 400 NJ	4		3,50
PARK 800 NJ	4		4,50
PARK 1200 NJ	4		6,80



PARK 400 NJ

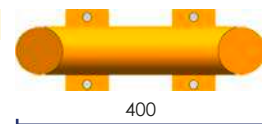

PARK 800 NJ

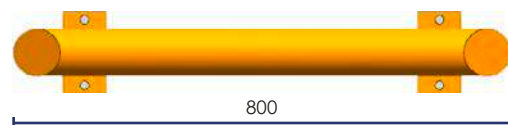

PARK 1200 NJ

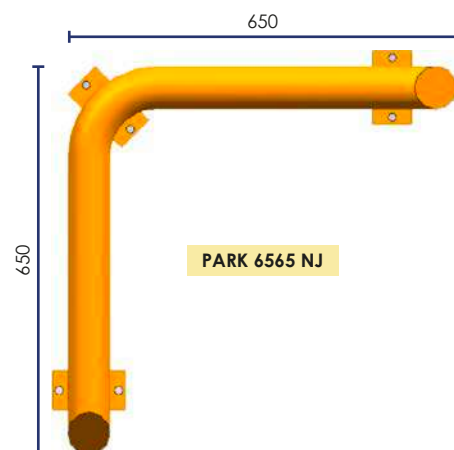
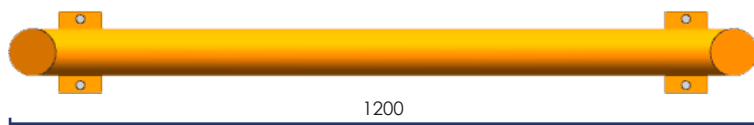

PARK 6565 NJ

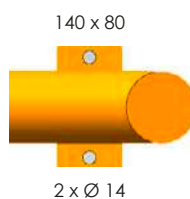

Ne pas installer en milieu salin ou Hydrocarbure. Nous consulter.  
Do not install in saline or Oil environment. Contact us.  
No lo instale en un ambiente salino o hidrocarburo. Consúltenos.  
Soll nicht in Salz oder Kohlenstoff Umgebung installiert werden, /uns Konsultieren.

OPTION ○ OPTIONAL ○ OPCIÓN ○ OPTIONAL



BAR FIX 1 SB



BAR FIX 304 SB





**BUTÉE DE PROTECTION**  
**ANTI-COLLISION BAR**  
**BARRA PROTECCIÓN ACERO**  
**EINSTELLBARE SCHUTZBÜGEL**



PEINTURE ÉPOXY  
 POWDER PAINTING  
 PINTURA EPOXICA  
 EPOXY FARBE



Code		
PARKSTEEL 80	4	6,70
PARKSTEEL 120	4	8,40
PARKSTEEL 200	6	14,00
PARKORNER	4	5,00

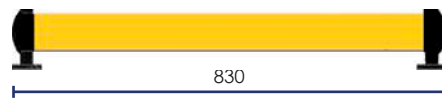

PARKSTEEL 80

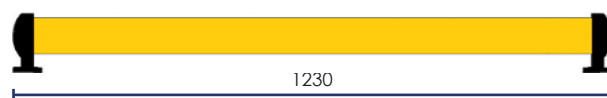

PARKSTEEL 120

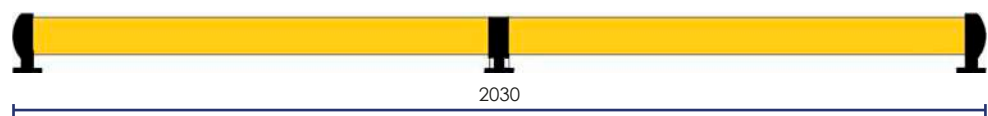

PARKSTEEL 200



Peut être coupé et ajusté à la longueur désirée.  
 Can be cut to the requested length.  
 Se puede cortar y ajustar a la longitud deseada.  
 Kann geschnitten und auf die gewünschte Länge angepasst werden..

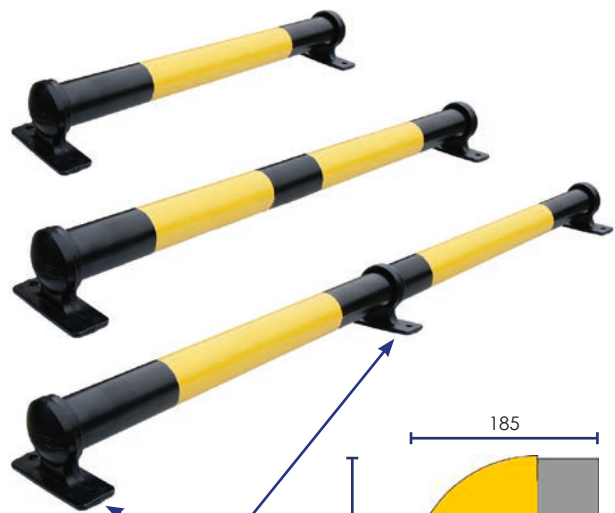

FORTE D'ACIER  
 IRON CAST  
 ACERO FUNDIDO  
 STAHLGUSS



OPTION  
 OPTIONAL  
 OPCIÓN  
 OPTIONAL



FSAFE 4 SB  
 Ø 12 x 120

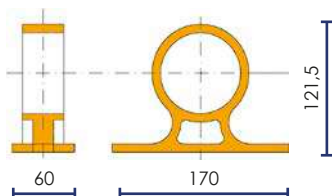

Ne pas installer en milieu salin ou Hydrocarbure.  
 Nous consulter.  
 Do not install in saline or Oil environment.  
 Contact us.  
 No lo instale en un ambiente salino o hidrocarburo.  
 Consúltenos.  
 Soll nicht in Salz oder Kohlenstoff Umgebung  
 installiert werden. /uns Konsultieren.









## POTEAUX INOX

STAINLESS STEEL POSTS ◦ POSTES DE ACERO INOXIDABLE ◦ EDELSTAHLPFOSTEN



Code	∅ mm			kg
POT 89 316				3,90
POTS 89 316	89	∅ 170		5,00
POT BOX 89			135 x 135 H 300	4,50
POT 159 316				11,50
POTS 159 316	159	∅ 240		12,20
POT BOX 159			175 x 145 H 300	11,00

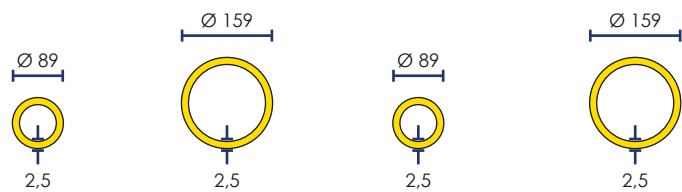

Fourni  
Supplied  
Includo  
Inklusive



POTS 89 316



POTS 159 316



POT 89 316

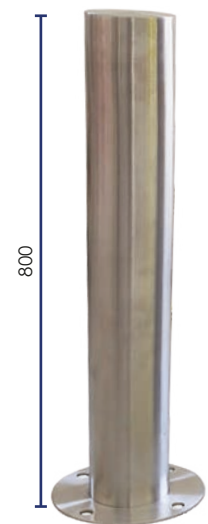

POT 159 316

OPTION ◦ OPTIONAL ◦ OPCIÓN ◦ OPTIONAL



BAR FIX 304 SB



POT BOX 89



POT BOX 159



- ▶ POT 2 RESB
- ▶ POT 2 ORSB
- ▶ POT 2 WHSB
- ▶ POT 2 BUSB
- ▶ POT 2 VERSB

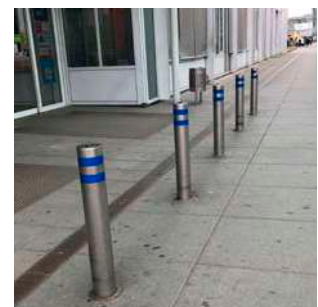

# POT LED

## POTEAUX ACIER À LED

LED STEEL POSTS ◦ POSTES CON LED ◦ STAHLROHRPOLLER MIT LED



Code	☀️	∅ Led	📊 kg
POT 90 LED RB	9	5	8
POT 160 LED RB	18	5	13

- Tube en ACIER
- Batterie lithium
- Intensité 6000 mcd
- Panneau solaire - IP65
- Visibilité 500 m
- Température -10 / +45 °C
- Durée de vie de la batterie : 3 ans
- 8h de soleil = 10 - 12 h d'autonomie
- STEEL tube
- Lithium battery
- Intensity 6000 mcd
- Solar glass panel - IP65 RATING
- Visibility 500m
- Temperature range -10/+45°.
- Battery life: 3 years
- 8 hours of sunlight = 10 - 12 hours autonomy

- Tubo de acero
- Bateria de Lítio
- Intensidad 6000 mcd
- Panel solar - IP65
- Visibilidad 500 m
- Temperatura -10 / +45 °C
- Duración de la batería: 3 años
- 8 horas de luz = 10-12 horas de autonomía
- Rohr aus STAHL
- Lithium Akku
- Intensität 6000 mcd
- Solarmodul - IP65
- Sichtbarkeit 500m
- Temperatur -10/+45°
- Batterielebensdauer: 3 Jahre
- 8h Sonne = 10h - 12h Laufzeit

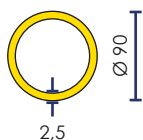

POT 90 LED RB

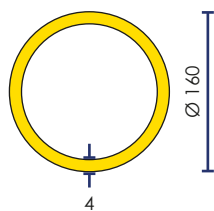

POT 160 LED RB

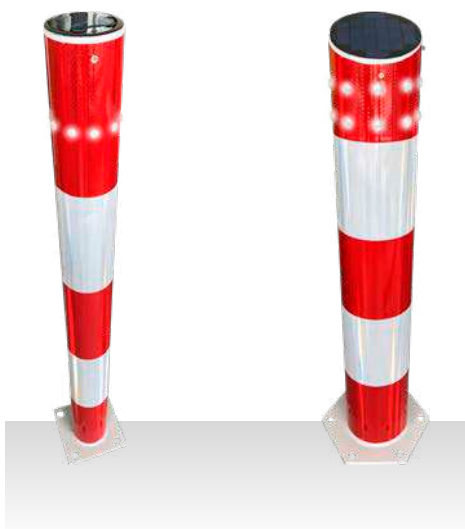

Clignote uniquement la nuit  
Flashes only at night  
Parpadeos sólo de noche  
Blinkt nur in der Nacht



4 x ∅ 14  
200 x 200



6 x ∅ 14  
150



Ne pas installer en milieu salin ou Hydrocarbure. Nous consulter.  
Do not install in saline or Oil environment. Contact us.  
No lo instale en un ambiente salino o hidrocarburo. Consúltanos.  
Soll nicht in Salz oder Kohlenstoff Umgebung installiert werden, /uns Konsultieren.

OPTION ◦ OPTIONAL ◦ OPCIÓN ◦ OPTIONAL



BAR FIX 1 SB



BAR FIX 304 SB





# POT / POTS

## POTEAUX ACIER

STEEL POTS ◦ POSTES DE ACERO ◦ STAHLPFOSTEN



Code	Ø mm	Color	kg
POT 800 NJ	90	Black/Yellow	7.30
POT 800 RB		Red/White	
POT 800 GAL		Grey	
POTS 800 NJ		Black/Yellow	5.30
POTS 800 RB		Red/White	
POTS 800 GAL		Grey	



Code	Ø mm	Color	kg
POT 90 NJ	90	Black/Yellow	10.00
POT 90 GAL	90	Grey	10.00
POT 159 NJ	159	Black/Yellow	21.00
POT 159 GAL	159	Grey	21.00
POT 273 NJ	273	Black/Yellow	48.00
POT 273 GAL	273	Grey	48.00
POT 1616 J	159	Yellow	18.20

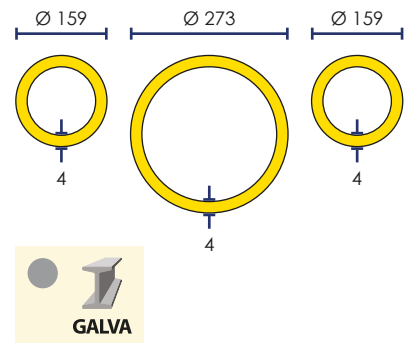

1550

1200

800  
H mm

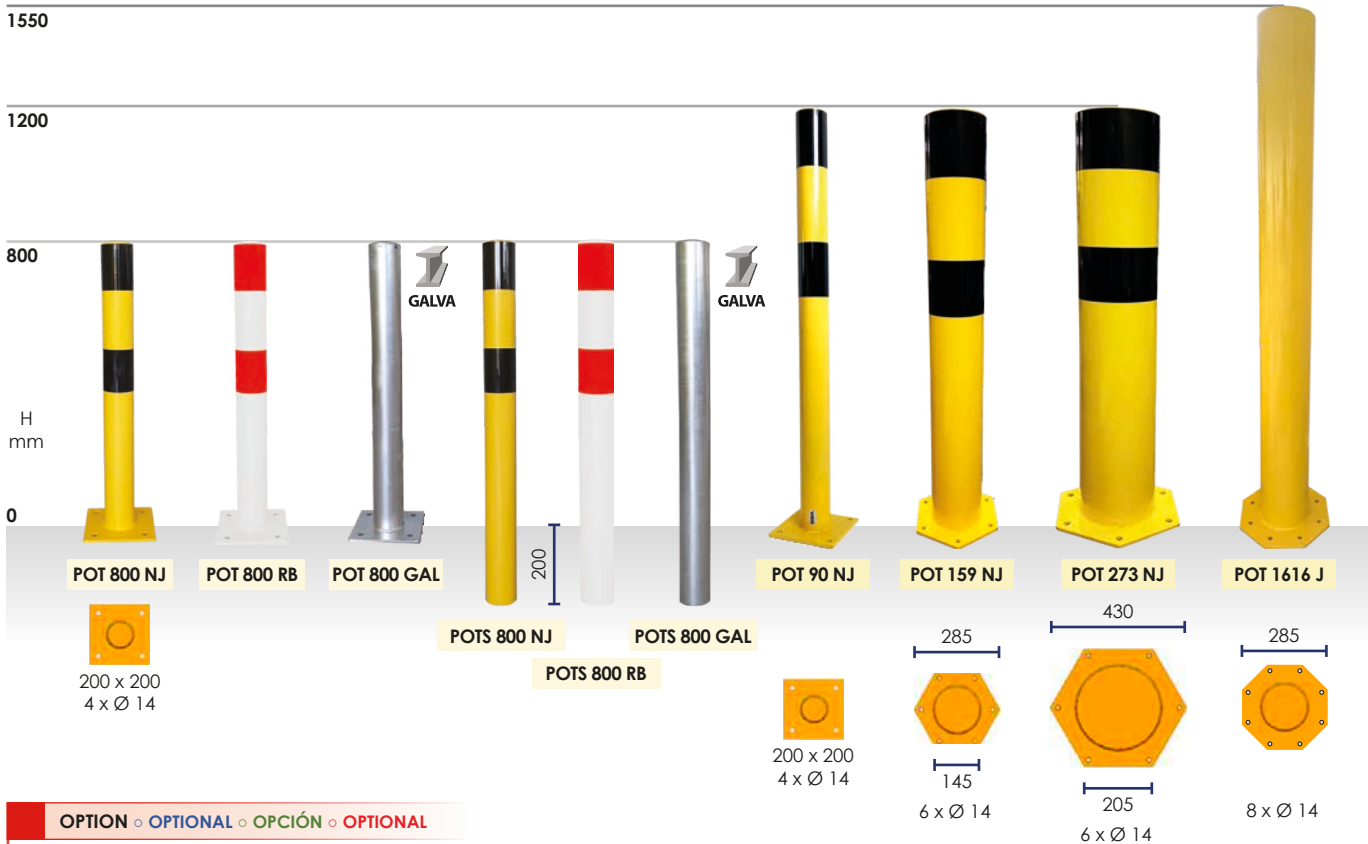

OPTION ◦ OPTIONAL ◦ OPCIÓN ◦ OPTIONAL

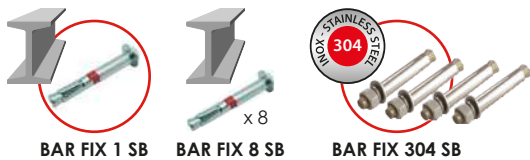

Ne pas installer en milieu salin ou Hydrocrabure. Nous consulter.  
Do not install in saline or Oil environment. Contact us.  
No lo instale en un ambiente salino o hidocraburo. Consúltenos.  
Soll nicht in Salz oder Kohlenstoff Umgebung installiert werden.  
/uns Konsultieren.

Sauf ◦ Except ◦ Salvo ◦ Nur









TPX

**ARCEAU FLEXIBLE À MÉMOIRE DE FORME**  
**FLEXIBLE HOOP** ◦ **BARRERA DE PROTECCIÓN FLEXIBLE**  
**RAMMSCHUTZBÜGEL MIT FORMGEDÄCHTNIS**

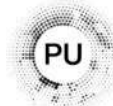

Code		
TPX 1235 NJ	350 x 1200 x 150	8,5
TPX 1275 NJ	750 x 1200 x 150	10,2
TPX 12100 NJ	1000 x 1200 x 150	11,8

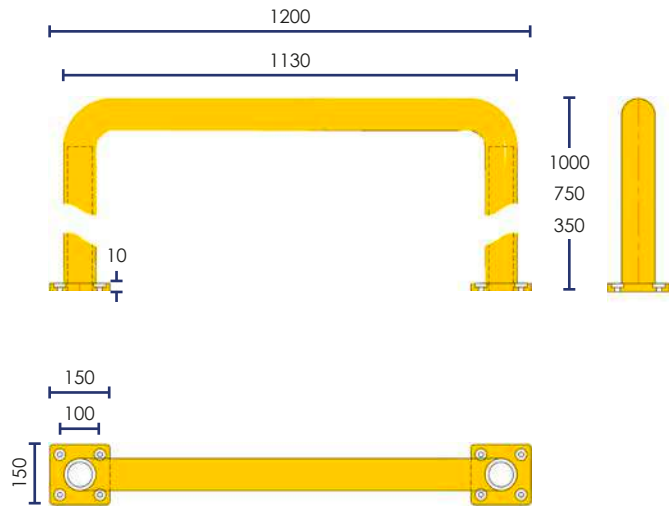
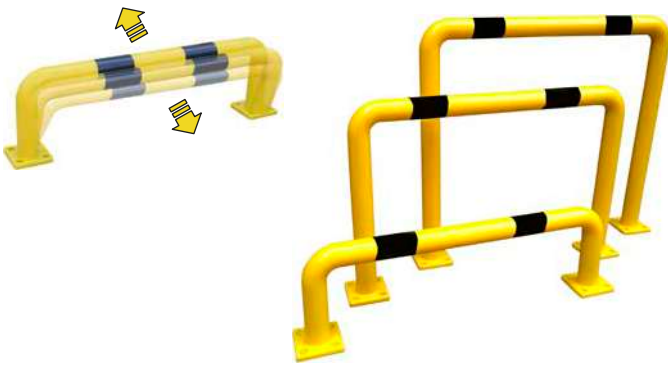

**BUTÉE FLEXIBLE À MÉMOIRE DE FORME**  
**FLEXIBLE PROTECTION BARS** ◦ **TOPES DE PROTECCIÓN FLEXIBLES**  
**FLEXIBEL RAMMSCHUTZBALKEN MIT FORMGEDÄCHTNIS**

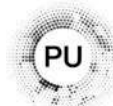

Code		
TPX 800 NJ	798 x 150 x 120	2,4
TPX 1200 NJ	1180 x 150 x 120	4,3
TPX 2000 NJ	1998 x 150 x 120	7,2

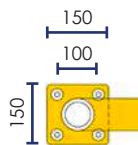
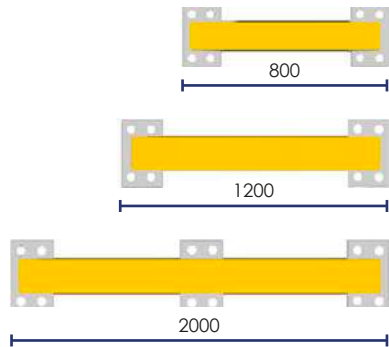

Capuchons ◦ Caps  
 Tapas ◦ Kappen

OPTION  
 OPTIONAL  
 OPCIÓN  
 OPTIONAL



TPU FIX 1 SB  
 Ø 12 x 80

\* < 20 °C - Nous consulter ◦ Ask us ◦ Consultarnos ◦ uns konsultieren



TPX

**POTEAUX FLEXIBLES À MÉMOIRE DE FORME**  
**FLEXIBLE BOLLARDS** ◦ **POSTES FLEXIBLES**  
**RAMMSCHUTZPOLLER MIT FORMGEDÄCHTNIS**

Ø 80 mm

PU

+ 50 °C  
- 20 °C\*

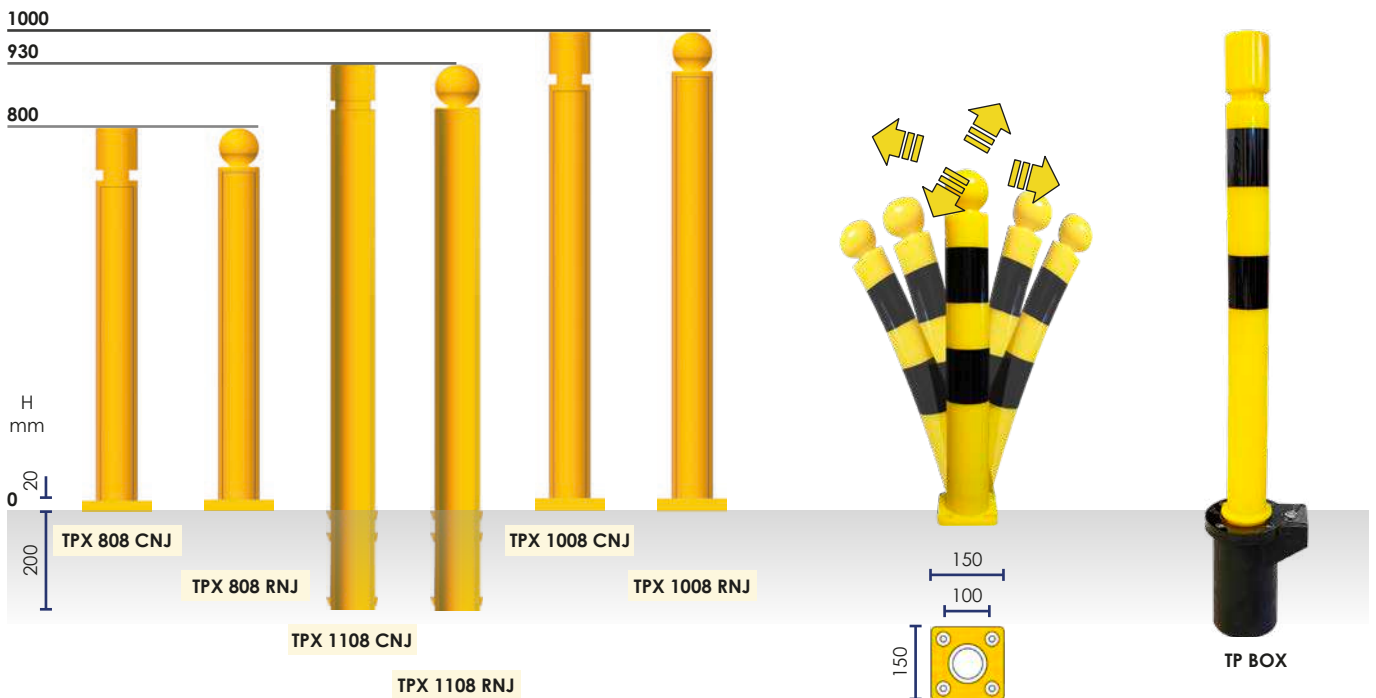

Code		
TPX 808 CNJ		3,00
TPX 808 RNJ		3,00
TPX 1108 CNJ		3,00
TPX 1108 RNJ		3,00
TPX 1008 CNJ		2,50
TPX 1008 RNJ		2,50

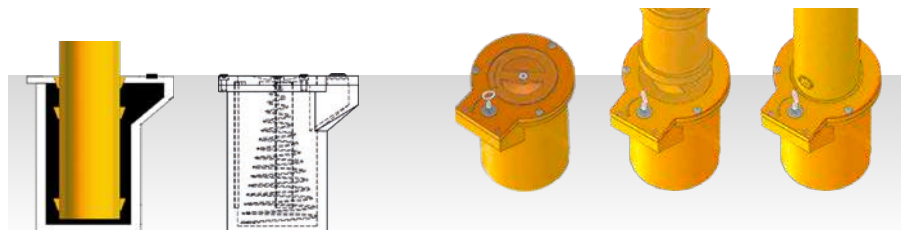

OPTION ◦ OPTIONAL ◦ OPCIÓN ◦ OPTIONAL



Capuchons ◦ Caps  
Tapas ◦ Kappen



TPU FIX 1 SB  
Ø 12 x 80



TPZ RING

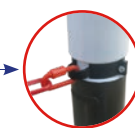

TP BOX 80

**BREVETÉ**  
PATENTED  
PATENTADO

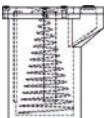

\* < 20 °C - Nous consulter ◦ Ask us ◦ Consultarnos ◦ uns konsultieren



Crealuxe.fr

# POTEAUX FLEXIBLES À MÉMOIRE DE FORME

FLEXIBLE BOLLARDS ◦ POSTES FLEXIBLES

RAMMSCHUTZPOLLER MIT FORMGEDÄCHTNIS

+ 50 °C  
- 20 °C\*

Code	Ø mm	Color	kg
TPX 40 NJ	100	Yellow/Black	2,00
TPX 60 NJ		Yellow/Black	2,40
TPX 710 NJ		Yellow/Black	2,50
TPX 710 RB		Red/White	2,50
TPX 810 CNJ		Yellow/Black	3,50
TPX 1110 CNJ	Yellow/Black	2,90	
TPX 140 NJ	140	Yellow/Black	7,00
TPX 160 NJ	160	Yellow/Black	7,00
TPX 270 NJ	270	Yellow/Black	10,50

OPTION ◦ OPTIONAL ◦ OPCIÓN ◦ OPTIONAL

TPU FIX 1 SB  
Ø 12 x 80

TPU RING

TP BOX 100

Capuchons ◦ Caps  
Tapas ◦ Kappen

\* < 20 °C - Nous consulter ◦ Ask us ◦ Consultarnos ◦ uns konsultieren

153





# MOUSSE DE PROTECTION

## FOAM PROTECTION ◦ PROTECTORES DE ESPUMA

### SCHAUMSTOFF SCHUTZ

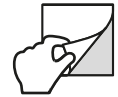

Copolymère d'éthylène et d'acétate de vinyle à cellules fermées extrêmement fines, impénétrables aux liquides.

Extremely fine closed cell of ethylene vinyl acetate copolymer, impenetrable to liquid.

Copolímero de etileno-acetato de vinilo extremadamente fino, impenetrable a los líquidos.

Ethylen-Vinylacetat, thermoplastisch. Ausgezeichnete Beständigkeit gegen Mineralölprodukte und Lösungsmittel.



Caoutchouc nitrile, copolymère acrylonitrile-butadiène. Excellente résistance aux produits pétroliers et aux solvants. Densité 105 kg/m³.

Nitrile rubber, acrylonitrile butadiene rubber is a synthetic rubber. Oil and grease resistant.

La goma de nitrilo es un copolímero de goma sintética. Más resistente a aceite y ácidos que el caucho natural. Densidad 105 kg / m³.

Nitrilkautschuk, Acrylnitril-Butadien-Copolymer mit ausgezeichneter Beständigkeit gegen Erdölprodukte und Lösungsmittel. Dichte 105 kg / m³.

# PROTECTIONS DE PROFILÉS ET D'ARÊTES

## RACKS AND EDGES PROTECTORS

### PROTECCIONES PARA RACKS Y VIGAS ◦ PROFIL- UND KANTENSCHUTZ

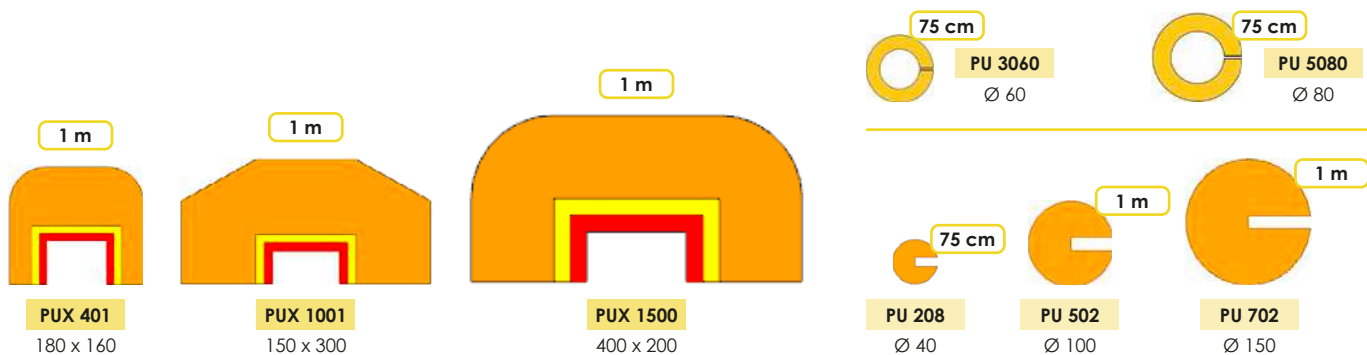

# PROTECTIONS D'ANGLES

## CORNER PROTECTION

### PROTECCIONES DE ESQUINAS ◦ ECKENSCHUTZ

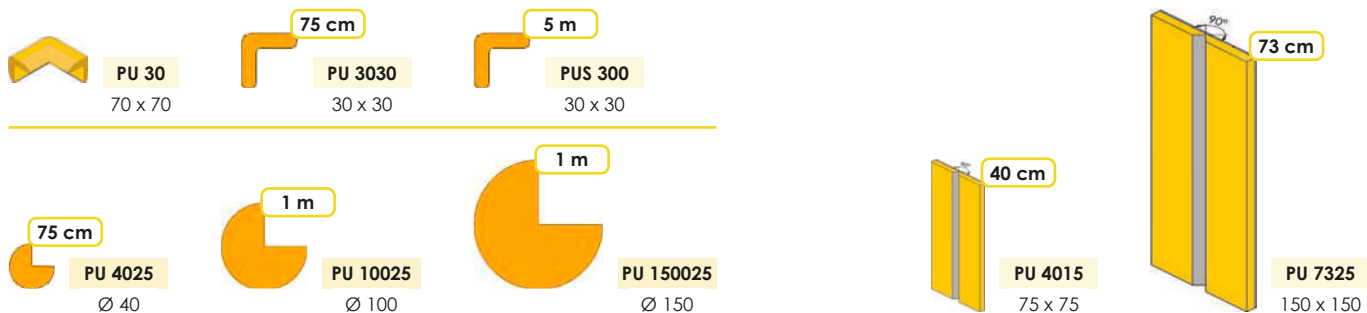

# PROTECTIONS DROITES

## WALL PROTECTION

### PROTECCIONES RECTAS ◦ WANDSCHUTZ

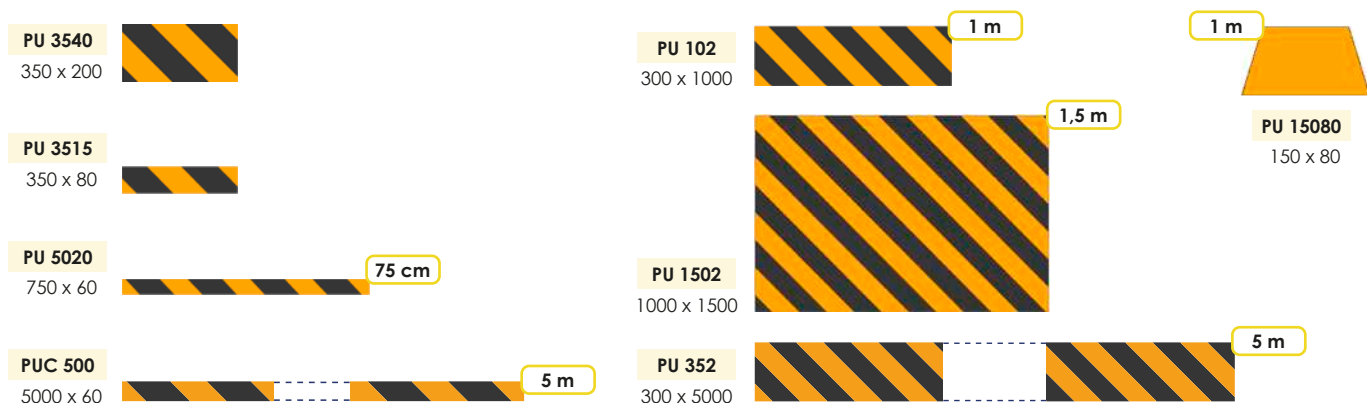



PUX

**PROTECTION DE PROFILÉ**  
**RACK PROTECTOR** ○ **PROTECCIÓN DE RACK**  
**PROFILSCHUTZ**



Code			
PUX 401		EVA	1,45

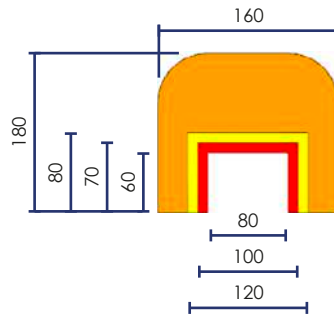
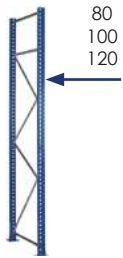

Code			
PUX 1001		EVA	1,65

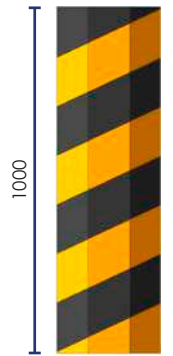
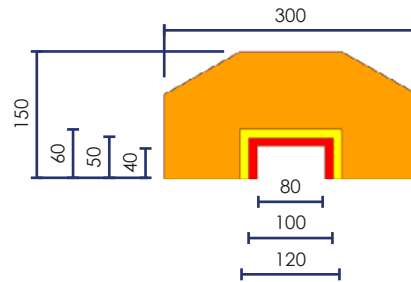
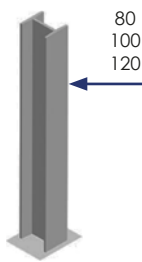

Code			
PUX 1500		EVA	1,65

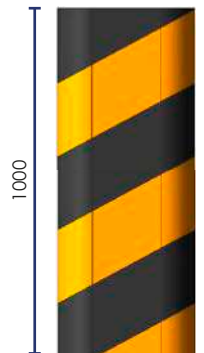
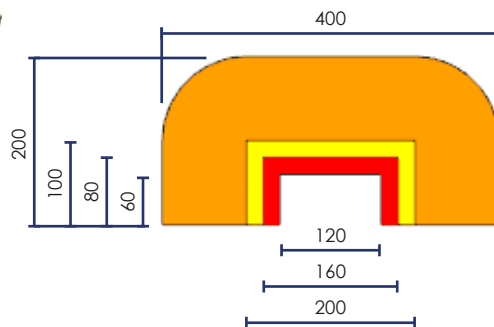
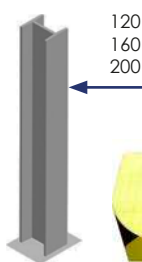





PU

## PROTECTION D'ARÊTE

EDGE PROTECTOR ◦ PROTECCIÓN DE VIGAS

### KANTENSCHUTZ



Code				
PU 208 RB		EVA	0,10	
PU 208 NJ		EVA	0,10	75 cm
PU 208 WH		EVA	0,10	
PU 502		EVA	0,25	
PU 702		EVA	0,60	1 m

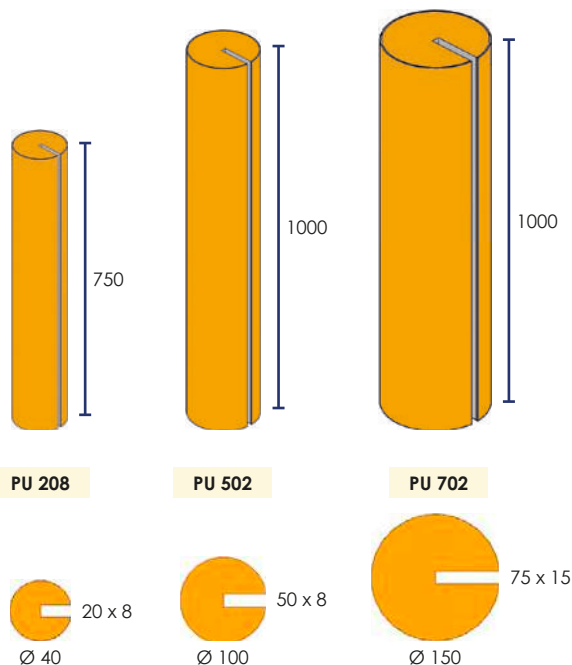

## PROTECTION DE TUBES ET TUYAUX

PIPE PROTECTOR ◦ PROTECCIÓN DE TUBOS

### SCHUTZ VON ROHREN UND LEITUNGEN



Code				
PU 3060 NJ		EVA	0,2	75 cm
PU 5080 NJ		EVA	0,3	

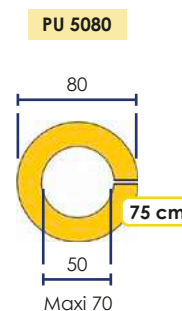
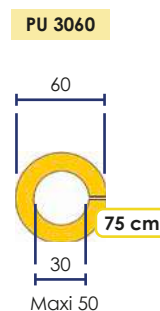
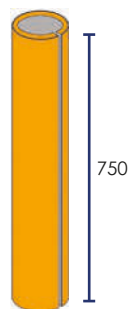

On referme l'adhésif sur le tube.

Tape to close over a tube.

Se cierra el adhesivo sobre el tubo.

Der Klebstoff wird auf der Schlauch Verschluss.



PU

**PROTECTION D'ANGLE**  
**CORNER PROTECTOR** ◦ **PROTECCIÓN DE ESQUINAS**  
**ECKENSCHUTZ**



Code				
PU 4025 RB		EVA	0,10	
PU 4025 NJ		EVA	0,10	75 cm
PU 4025 WH		EVA	0,10	
PU 10025		EVA	0,20	1 m
PU 150025		EVA	0,50	

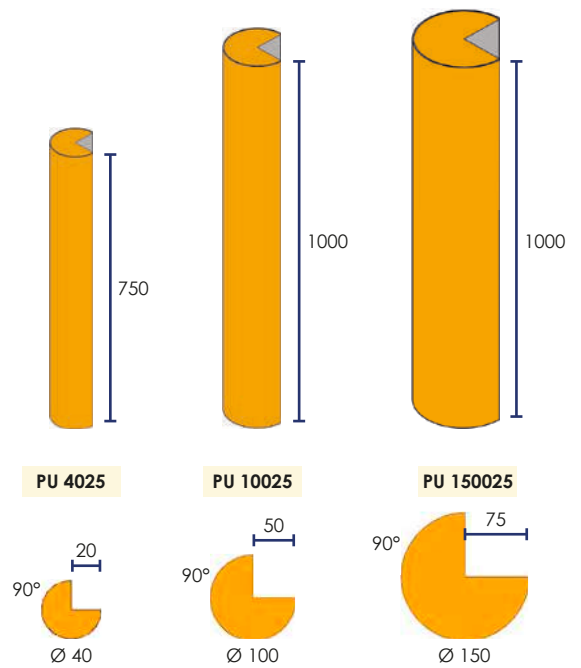

Code				
PU 4015 RB		EVA	0,04	40 cm
PU 4015 NJ		EVA	0,04	
PU 7325 RB		EVA	0,08	73 cm
PU 7325 NJ		EVA	0,08	

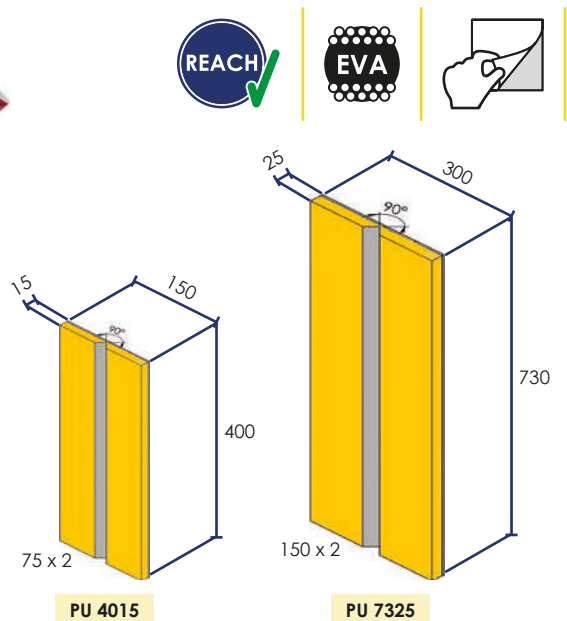





PU

# PROTECTION D'ANGLE

## CORNER PROTECTION ◦ PROTECCIÓN DE ANGULOS

### ECKENSCHUTZ



Code			
PU 30 RB *		NBR	0,015
PU 30 NJ		NBR	0,015
PU 30 WH		NBR	0,015

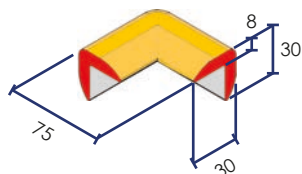

Code				
PU 3030 RB *		NBR	0,08	
PU 3030 NJ		NBR	0,08	75 cm
PU 3030 WH		NBR	0,08	
PUS 300 RB *		NBR	0,55	
PUS 300 NJ		NBR	0,55	5 m



PU 3030



PUS 300

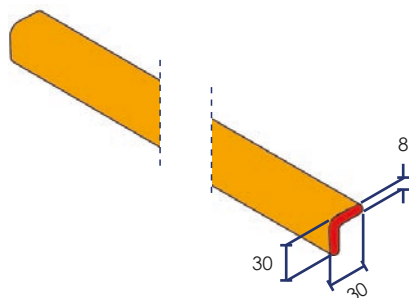

\* Jusqu'à épuisement du stock ◦ While stock lasts ◦ Hasta agotar existencias ◦ Solange der Vorrat reicht



# PU 15080

## BUTOIR BUMPER ◦ TOPE DE PROTECCIÓN STOBSTANGE



Code			
PU 15080		EVA	0,30

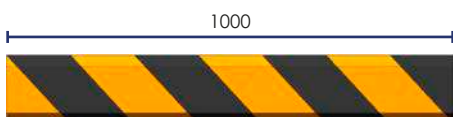
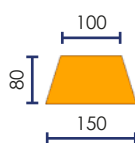

## PROTECTIONS DROITES WALL PROTECTOR ◦ PROTECCIÓN RECTA WANDSCHUTZ



Code			
PU 3515 RB		EVA	0,07
PU 3515 NJ		EVA	0,07
PU 3540 RB		EVA	0,15
PU 3540 NJ		EVA	0,15

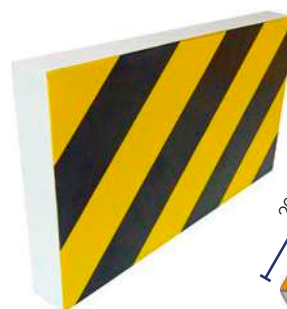
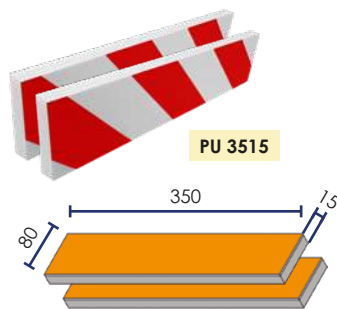

PU 3540

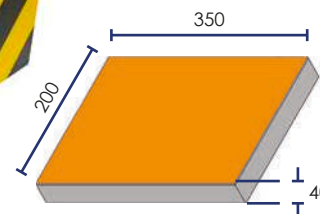

Code				
PU 5020 RB *		NBR	0,125	75 cm
PU 5020 NJ		NBR	0,125	
PU 5020 WH		NBR	0,125	
PUC 500 RB *		NBR	0,840	5 m
PUC 500 NJ		NBR	0,840	



\* Jusqu'à épuisement du stock ◦ While stock lasts ◦ Hasta agotar existencias ◦ Solange der Vorrat reicht





PU

**PROTECTIONS DROITES**  
**WALL PROTECTOR** ◦ **PROTECCIÓN RECTA**  
**WANDSCHUTZ**



Code				
PU 102 RB		NBR	0,32	<b>1 m</b>
PU 102 NJ		NBR	0,32	
PU 352 RBG		NBR	1,6	<b>5 m</b>
PU 352 NJ		NBR	1,6	
PU 1502 RBG		NBR	1,35	<b>1,5 m</b>
PU 1502 NJ		NBR	1,35	

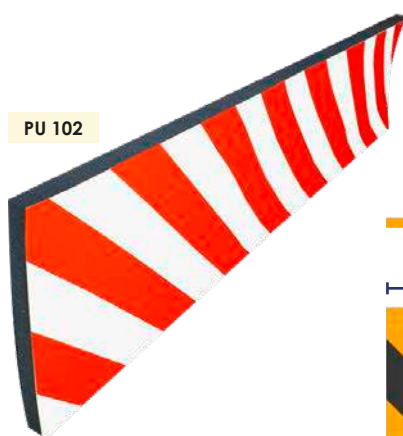

PU 102



PU 352

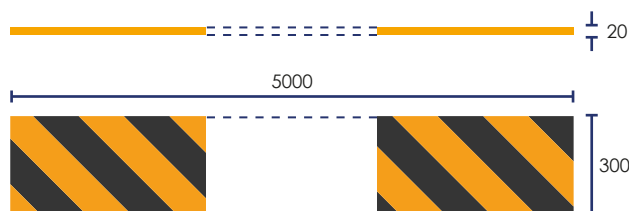

PU 1502





RQ 1000

**PROTECTIONS D'ANGLE** ◦ **CORNER PROTECTION**  
**PROTECTOR DE ESQUINAS** ◦ **RAMMSCHUTZECKE**



Code			
RQ 836		4 x 8 mm	1,30
RQ 800		6 x 10 mm	3,80
SQ 818		6 x 10 mm	4,40

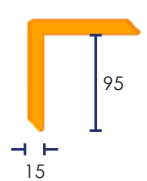
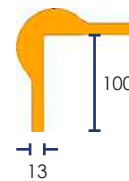
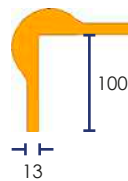
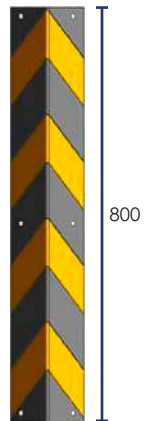
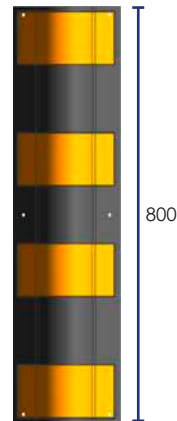
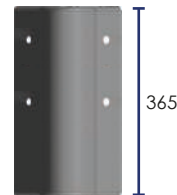

**PROTECTION DE MUR** ◦ **WALL PROTECTOR**  
**PROTECTOR DE PARED** ◦ **WANDRAMMSCHUTZ**



Code			
RQ 1000		3 x 12 mm	7,50

OPTION  
 OPTIONAL  
 OPCIÓN  
 OPTIONAL



FIXSAFE  
 Ø 12 x 120

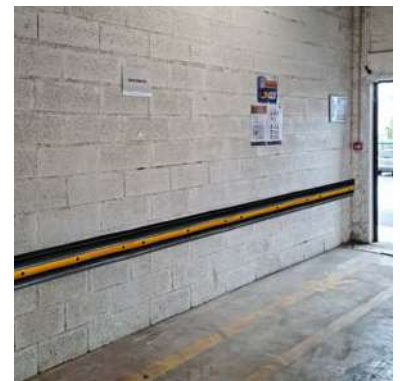
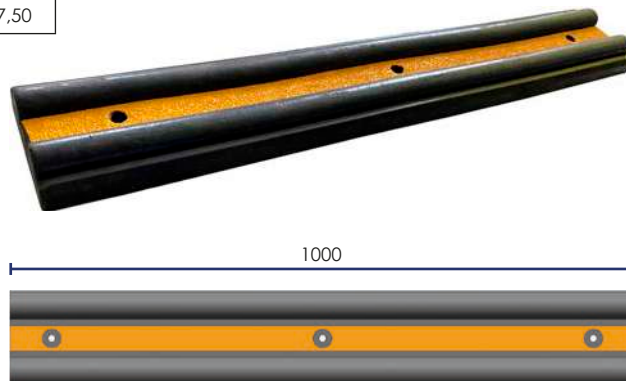





RQP 114

RTU 820

**PROTECTIONS D'ANGLE** ◦ CORNER PROTECTION  
**PROTECTOR DE ESQUINAS** ◦ RAMMSCHUTZECKE



CAOUTCHOUC  
 RUBBER  
 CAUCHO  
 KAUSCHUK

Code			
RQP 114 NJ		6 x 4 mm	1,70
RQR 114 NJ		6 x 4 mm	2,50



RQR 114 NJ



RQP 114 NJ



RQR 114 NJ

RQP 114 NJ

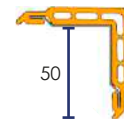

RQP 114 NJ



RQR 114 NJ

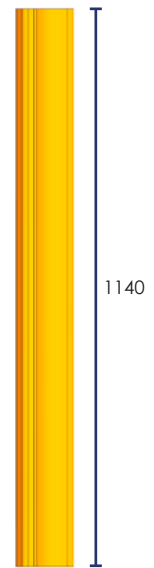

**PROTECTIONS DE CANALISATION** ◦ PIPE PROTECTOR  
**PROTECTOR DE TUBERÍA** ◦ SÄULENSCHUTZ



CAOUTCHOUC  
 RUBBER  
 CAUCHO  
 KAUSCHUK

Code			
RTU 815 NJ		8 x 6 mm	3,50
RTU 820 NJ		8 x 6 mm	5,00

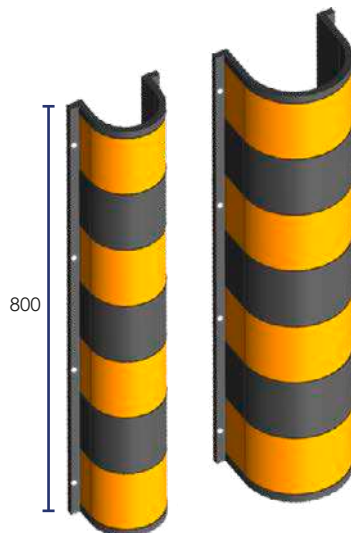

RTU 815 NJ

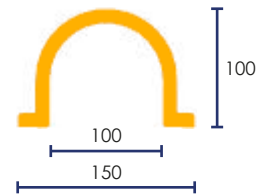

RTU 820 NJ

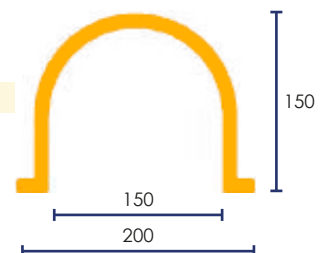



**BRA 1000**

**POD 81 ALU**

**EQUIPEMENTS DE QUAIS** ◦ DOCK EQUIPMENT  
**EQUIPAMIENTO PARA MUELLES DE CARGA** ◦ LADERAMPEN ZUBEHÖR

**PROJECTEUR DE QUAIS À LED**  
 DOCK LED LIGHT ◦ FOCO LED MUELLE DE CARGA ◦ LED SCHEINWERFER



- Projecteur de quai avec lampe led sur bras articulé en acier.
- Longueur déployé 1,25 m. Longueur fermé 85 cm.
- Câble inséré dans les tubes.
- Platine avec 4 fixations murales.
- Lampe led 50 W AC 85-265 V - IP 65.
- Luminosité 80 lm/w - 100 lm/w (valeurs d'efficacité lumineuse) 6500 K (Kelvins).

- Steel articulated arm with led light.
- Extended length 1.25m. Closed length 85 cm.
- Wires inserted in the tubes.
- Plate with 4 wall mountings.
- Led lamp 50 W AC 85-265V - IP 65.
- Brightness 80lm/w-100lm/w (light efficiency) 6500 K (Kelvins).

- Foco de muelle a led en brazo de acero articulado.
- Longitud extendida 1.25m. Longitud cerrada 85 cm.
- Cable insertado en los tubos.
- Placa con 4 fijaciones murales.
- Lámpara led 50 W AC 85-265V - IP 65.
- Luminosidad 80lm/w-100lm/w (valores de eficacia luminosa) 6500 K (Kelvins).

- Dock-Projektor mit LED-Lampe ans Stahlgelenkarm.
- Entfaltete Länge 1.25 m. Geschlossene Länge 85 cm.
- In die Rohre eingestztes Kabel.
- Platine mit 4 Wandhalterungen.
- AC 50W LED- Lampe 85-265 V - IP65.
- Helligkeit 80 lm/w - 100 lm/w (werte der Lichtausbeute) 6500 K (Kelvin).

**PROTECTION DE VOIRIE** ◦ GROUND PROTECTION ◦ PROTECCIONES DE SUELO ◦ ABSTÜTZPLATTEN

Code		
<b>POD 81 ALU</b>	820 x 610	2,2



**POD 81 ALU**

Code		
<b>POD 304 INOX *</b>	820 x 610	7,5
<b>POD 316 INOX *</b>		7,5



**POD - INOX**



\* Sur commande ◦ Under request ◦ bajo pedido ◦ Auf Bestellung





## PROTECTION DE QUAIS ◦ DOCKS BUMPERS PROTECTOR MUELLE DE CARGA ◦ LADERAMPENSCHUTZ



RB 300

RB 500



RB 500 TPU

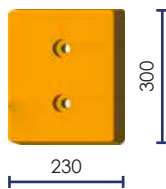

RB 300

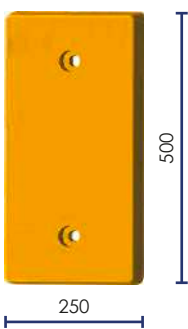

RB 500



Code		
RB 300	300 x 230 x 105	9,0
RB 500	500 x 250 x 100	16,0
BRB 300	320 x 270 x 10	7,5
BRB 500	500 x 250 x 10	10,0



BRB 300

BRB 500

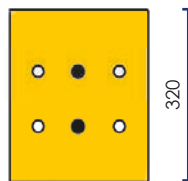

BRB 300

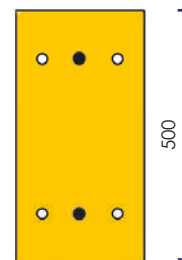

BRB 500

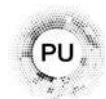

Code		
RB 500 TPU	500 x 250 x 100	5,0
BRB 502	520 x 275 x 10	16,0

Blocage 4 côtés.  
4 sides stops.  
Bloqueo con 4 esquinas.  
4 Seiten Stopp.



BRB 502

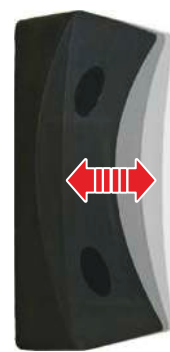

RB 500 TPU

Heurtoir en polyuréthane. Se déforme et revient ensuite à sa position.  
Bumper made of polyurethane. Absorbs shocks and returns to its original position.

Protección de muelle en poliuretano. Absorbe los golpes y vuelve a su posición inicial.

Dock-Schutzladerampe aus Polyurethan, stoßdämpfend.

## PANNEAU SOLAIRE A LED SOLAR LED TRAFFIC SIGN PANEL DE TRAFICO CON LED LEUCHTTAFELN

PNX-5070-CHARIOT

550 x 700 mm



Informations techniques, voir page 35  
Technical specifications see page 35  
Datos técnicos ver página 35  
Technische Informationen, siehe Seite 35



# RQDB

## PROTECTION HAUTE RÉSISTANCE HEAVY DUTY BUMPERS ◦ PROTECCIÓN ALTA RESISTENCIA RAMMSCHUTZ MIT HOHEM WIDERSTAND



CAOUTCHOUC VULCANISÉ  
VULCANIZED RUBBER  
CAUCHO VULCANIZADO  
VULKANISIERTEM KAUSCHUK

Code			
RQDB 100	●	3	8,45
RQDB 150	●	2	14,00
RQDB 200	●	3	32,00





**RQDB 100**







**RQDB 150**







**RQDB 200**

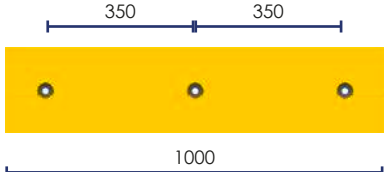





# Créaluxe.fr

Crealuxe SARL  
BP 4003584101 Orange CEDEX  
04 86 71 54 42  
serviceclient@crealuxe.fr

