



Collectivités ◦ Welcome





BURGER & STEAK HOUSE

crealuxe.fr

OLE

PEPPERICO

TAPAS

Début de la file d'attente FNAC.

Ensemble, bientôt

Westfield VÉLIZY 2

Merci de respecter les distances de sécurité

Merci de respecter les distances de sécurité

file d'attente FNAC



**COMMENT CHOISIR SON POTEAU ?** ◦ HOW TO CHOOSE YOUR STANCHION?  
 ¿CÓMO ELEGIR SU POSTE? ◦ WIE WÄHLEN SIE IHREN PFOSTEN AUS?

**1. INTÉRIEUR OU EXTÉRIEUR ?** ◦ INDOOR OR OUTDOOR ?  
 INTERIOR ◦ EXTERIOR ? ◦ ANWENDUNG: INNEN ODER AUSSEN?



**2. JE CHOISIS LA LONGUEUR ET LA LARGEUR DE MA SANGLE**  
 I CHOOSE THE LENGTH AND WIDTH OF MY BELT ◦ ELIJO EL LARGO Y EL ANCHO DE MI CINTA  
 DIE BREITE UND LÄNGE DES ABSPERRBANDES WÄHLEN

INTÉRIEUR ◦ INDOOR ◦ INTERIOR ◦ INNEN



EXTÉRIEUR ◦ OUTDOOR ◦ EXTERIOR ◦ AUSSEN

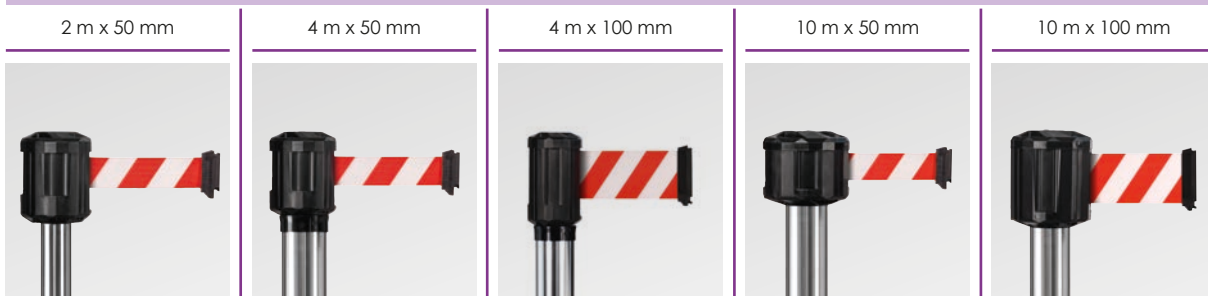



**3. JE CHOISIS LA COULEUR DE MA SANGLE** ◦ I CHOOSE THE COLOR OF MY BELT  
 ELIJO EL COLOR DE MI CINTA ◦ DIE FARBE DES BANDES AUSWÄHLEN

2 M X 50 MM 4 M X 50 MM 4 M X 100 MM 10 M X 50 MM 10 M X 100 MM Sangle freinée Braked strap Cinta frenada Absperrgurt mit Bremsvorrichtung						
	<b>BU</b>	<b>VE</b>	<b>RE</b>	<b>JA</b>	<b>GR</b>	<b>BK</b>
						
	<b>RB</b>	<b>NJ</b>	<b>ENT</b>	<b>STOP</b>		
						
	<b>DAN</b>	<b>BYB</b>	<b>BBR</b>	<b>IS</b>		

▲ Sangle personnalisée, nous consulter ◦ Customized belt, consult us.  
 Cinta personalizada, consultarnos ◦ Gurt Personalisierung, uns konsultieren.



**4. JE CHOISIS LA COULEUR DE MON TUBE** ◦ I CHOOSE THE COLOR OF MY TUBE  
 ELIJO EL COLOR DE MI TUBO ◦ DIE FARBE DES STÄNDERS AUSWÄHLEN

										
<b>BK</b>	<b>GR</b>	<b>SR</b>	<b>RB</b>	<b>RE</b>	<b>OR</b>	<b>JA</b>	<b>NJ</b>	<b>VE</b>	<b>BU</b>	<b>WH</b>



**5. JE CHOISIS MA BASE** ◦ I CHOOSE MY BASE  
 ELIJO MI BASE ◦ DIE BODENPLATTE AUSWÄHLEN

<p><b>ECO</b></p>	<p><b>NOMAD</b></p>
<p>2 m (2,5 kg)</p>	<p>2 m / 4 m (8 kg)</p>
	
<p><b>CLASSIC</b></p>	
<p>2 m (8,1 kg)</p>	<p>4 m (8,5 kg)</p>
	
<p><b>FIX</b></p>	<p><b>AMOVIBLE</b></p>
<p>2 m   4 m</p>	<p>2 m / 4 m</p>
	
<p><b>HEAVY</b></p>	<p><b>À LESTER</b></p>
<p>2 m / 4 m (14 kg)</p>	<p>4 m (8,3 kg *)</p>
	

\* avec de l'eau ◦ with water ◦ Con agua ◦ mit Wasser



**6. OPTION : JE CHOISIS MES ACCESSOIRES** ○ OPTION : I CHOOSE MY ACCESSORIES  
 OPCIÓN: ELIJO MIS ACCESORIOS ○ ALTERNATIVEN: ZUBEHÖR AUSWÄHLEN

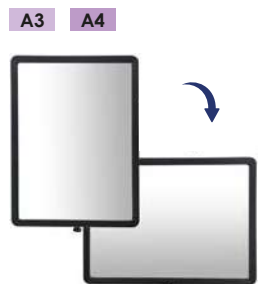
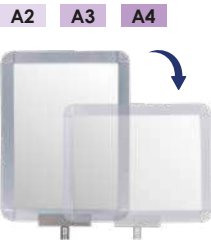

A2 A3 A4



CONNECTEUR ○ CONNECTOR  
 CONECTOR ○ VERBINDUNGSELEMENT



**RS2 \***  
Type base / longueur de sangle \*  
Base type / belt length  
Tipo base / largo cinta  
Bodenhülse / Die Länge des Absperribandes

**BK**  
Couleur poteau  
Color post  
Color poste  
Farbauswahl der Pfosten

**RE**  
Couleur sangle  
Belt color  
Color cinta  
Gurt-Farbe

**RS2BKRE**

**COULEUR POTEAU** o POST COLOR  
COLOR POSTE o FARBAUSWAHL DER PFOSTEN

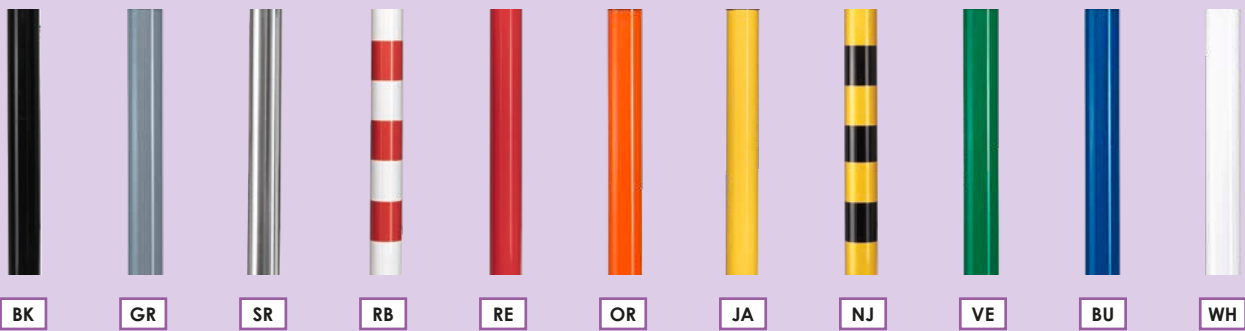

**STANDARD**

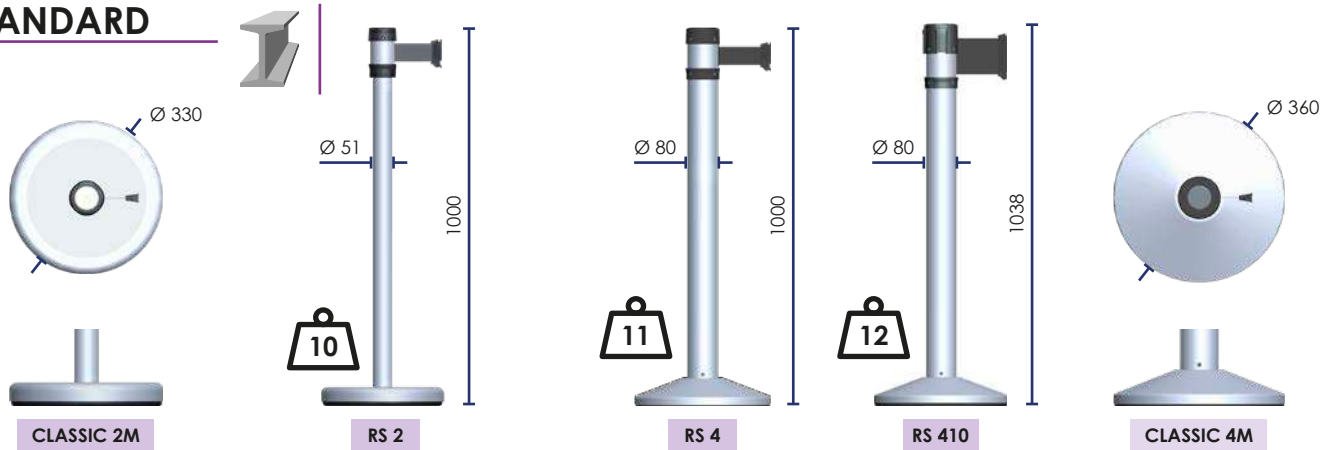

**BASE U** o U BASE  
BASE EN U  
U-BASISPLATTE

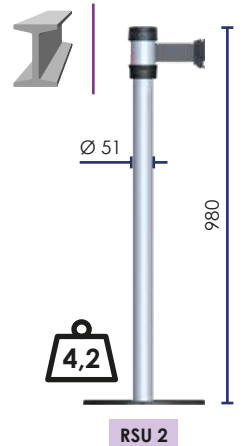
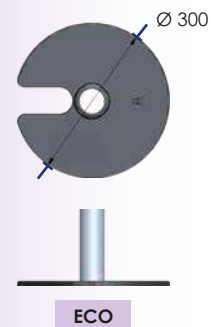





**INTÉRIEUR** Crealux.fr **INDOOR**  
**INTERIOR** ◦ **INNEN AUSFÜHRUNG**

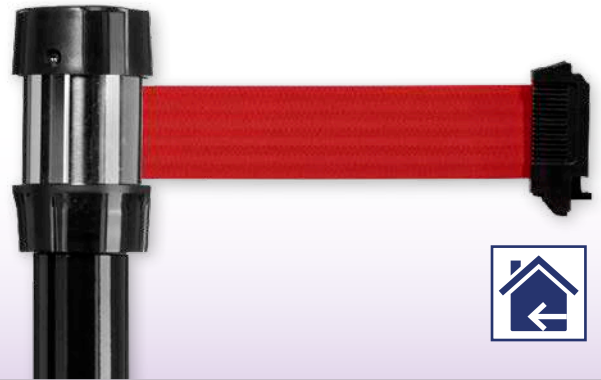

**COULEUR SANGLE** ◦ **BELT COLOR**

**COLOR CINTA** ◦ **GURT-FARBE**

2 M X 50 MM  
4 M X 50 MM

4 M X 100 MM

Sangle freinée  
Braked strap  
Cinta frenada  
Abspergurt mit  
Bremsvorrichtung



**BASE FIXE** ◦ **FIXED BASE**

**BASE FIJA**

**BODENBEFESTIGUNG FEST**

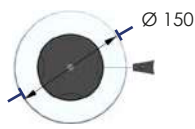

FIX

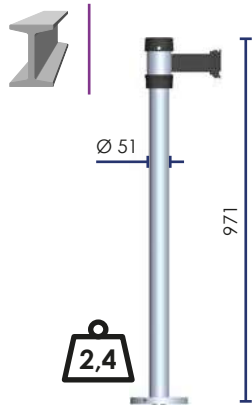

RSF 2

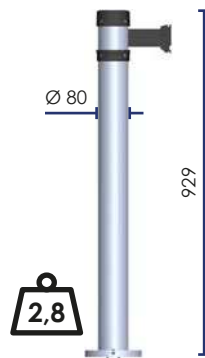

RSF 4

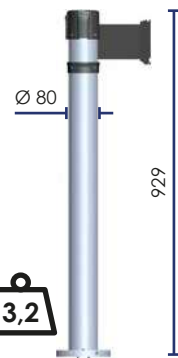

RSF 410

**AMOVIBLE** \* ◦ **REMOVABLE**

**EXTRAÍBLE** ◦ **ABNEHMBAR**

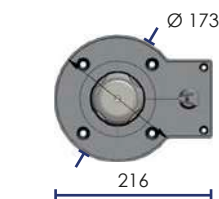

175



RS BOX

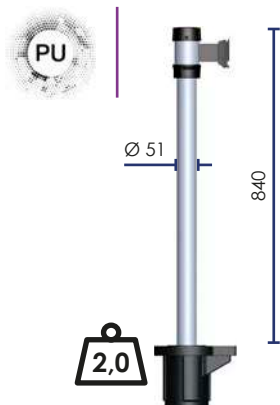

RSB 2

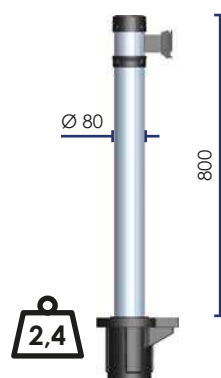

RSB 4

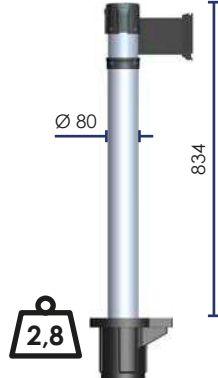

RSB 410

\* Poteau amovible ◦ Removable post ◦ Poste extraíble ◦ Abnehmbarer Pfosten

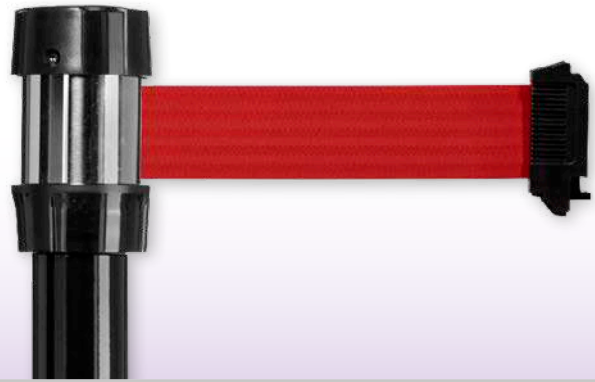

**ROULETTES** ◦ WHEELS  
 RUEDAS ◦ RUNDERFUSS



NOMAD

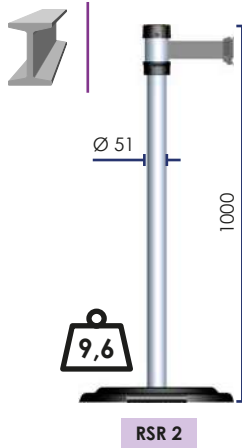

RSR 2

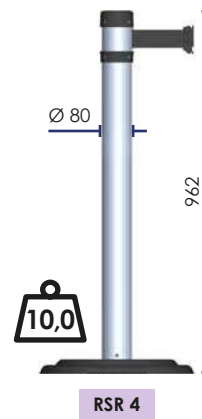

RSR 4

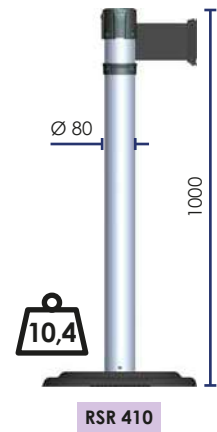

RSR 410

**HEAVY**

FONTE D'ACIER  
 IRON CAST  
 ACERO FUNDIDO  
 STAHLGUSS

- Lourde
- À roulettes
- Rangement
- Heavy
- Wheels
- Storage

- Pesada
- Ruedas
- Almacenamiento

- Schwer
- Rund
- Stapelbar

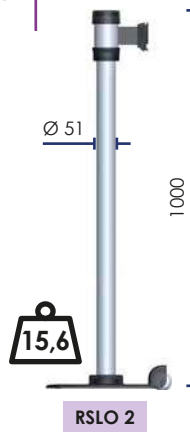
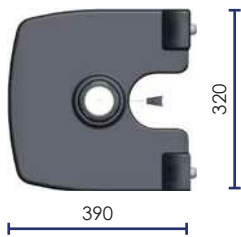

RSLO 2

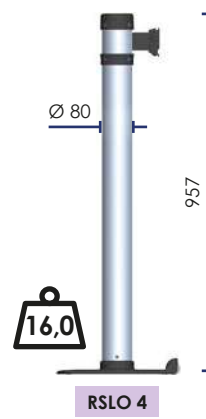

RSLO 4

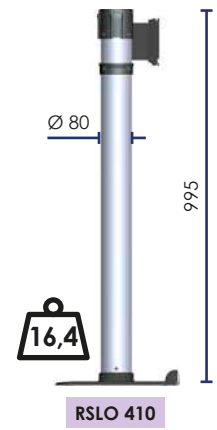

RSLO 410

**À LESTER** ◦ TO BE LOADED  
 LASTRABLE ◦ BEFÜLBAR

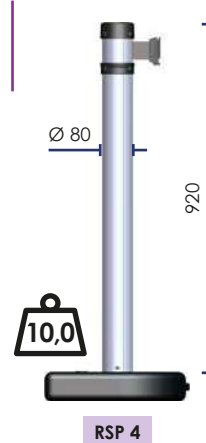
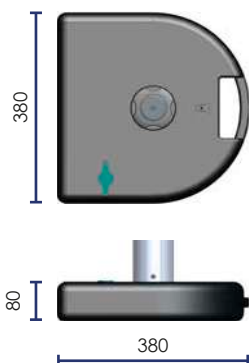

RSP 4

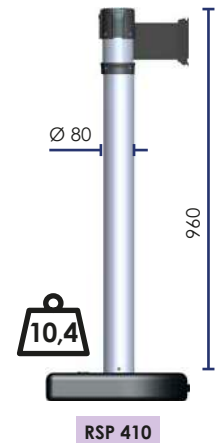

RSP 410



**INTÉRIEUR** Crealux.fr **INDOOR**  
**INTERIOR**  
**INNEN AUSFÜHRUNG**



**RW**

**ENROULEUR MURAL** ◦ **WALL MOUNTED BARRIER**  
**ENROLLADOR MURAL DE CINTA** ◦ **WANDAUFROLLER**



- Enrouleur mural à sangle pour limiter facilement l'accès à une zone
- Sangle freinée
- Tête orientable
- Récepteur mural et fixations inclus
- Personnalisation de sangle sur demande
- Wall-mounted retractable belt to easily limit access to an area
- Braked strap
- Adjustable head
- Wall receiver and fixings included
- Strap customization on demand
- Enrollador mural de cinta para limitar fácilmente el acceso a un área
- Cinta con freno
- Cabezal ajustable
- Receptor de pared y fijaciones incluidos.
- Personalización de la cinta bajo pedido
- Durch den Wandaufroller kann der Zugang für bestimmte Bereiche eingeschränkt werden
- Absperrgurt mit Bremsvorrichtung
- Verstellbarer Kopf
- Inklusive Wandaufroller und Befestigungsmaterial
- Gurtlänge Änderung - auf Anfrage

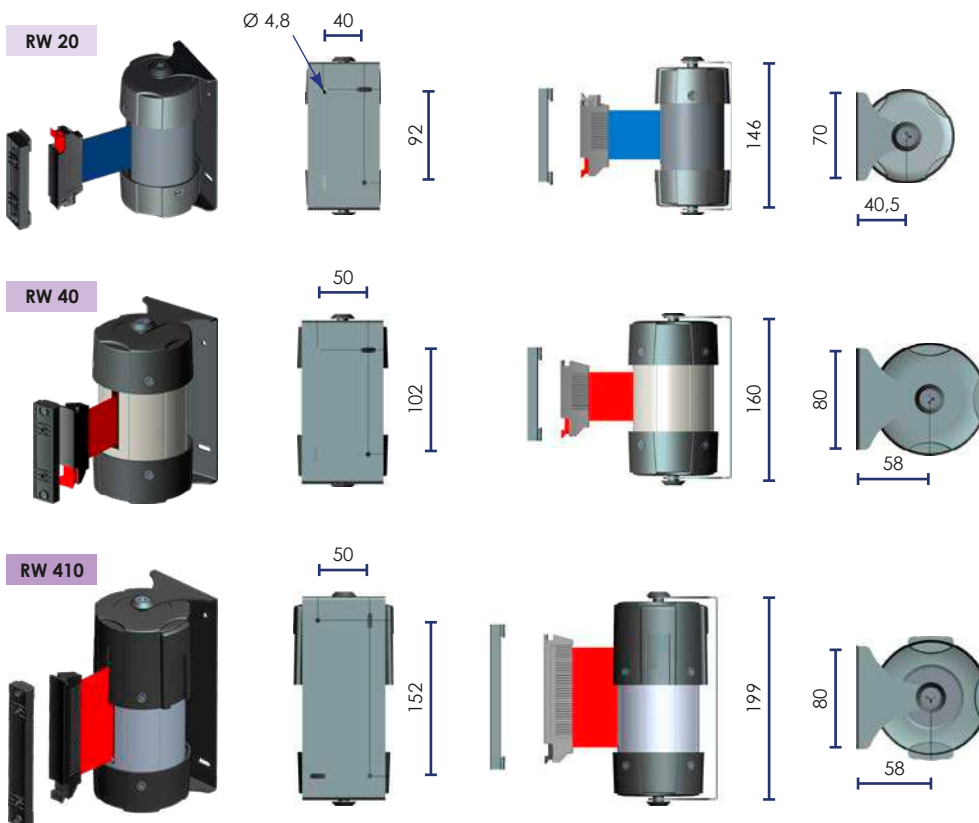

► RW 20 / 40 / 410

BU	VE	RE
RB	NJ	ENT
DAN	BYB	BBR
JA	GR	BK
STOP	STOP	STOP
IS	ISSUE DE SECOURS	



**INCLUS** ◦ **INCLUDED**  
**INCLUIDO** ◦ **INKLUSIVE**

**OPTION** ◦ **OPTIONAL**  
**OPCIÓN** ◦ **OPTIONAL**

Dispositif anti-panique  
 No panic device ◦ Dispositivo antipánico  
 Anti-Panik-Gerät



## COULEUR POTEAU ○ POST COLOR COLOR POSTE ○ FARBAUSWAHL DER PFOSTEN

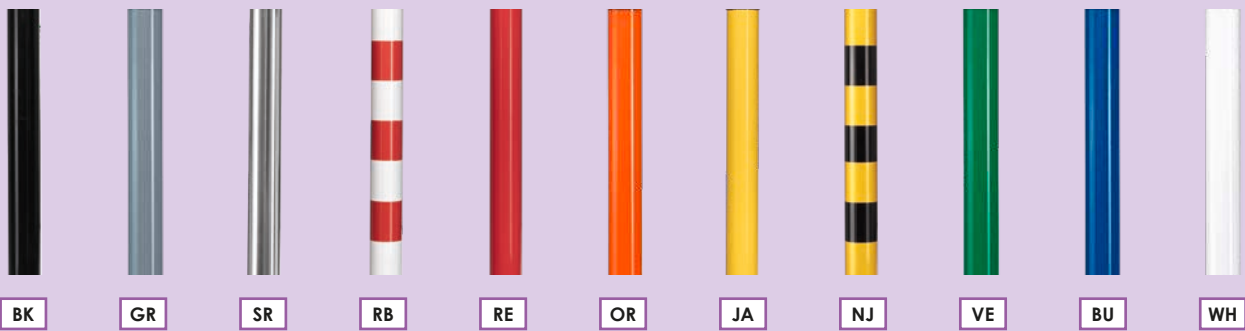

### STANDARD

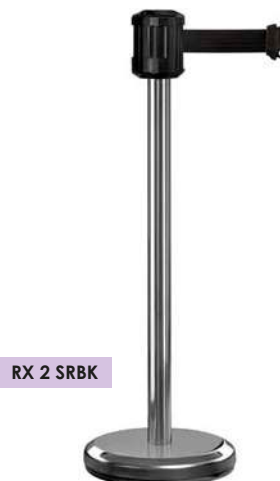
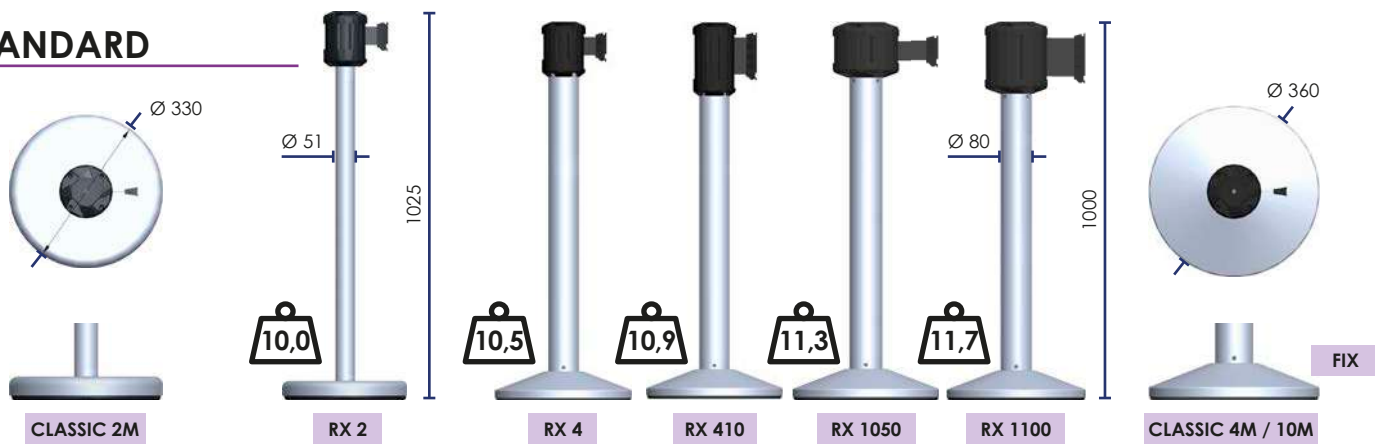

### BASE U ○ U BASE BASE EN U U-BASISPLATTE

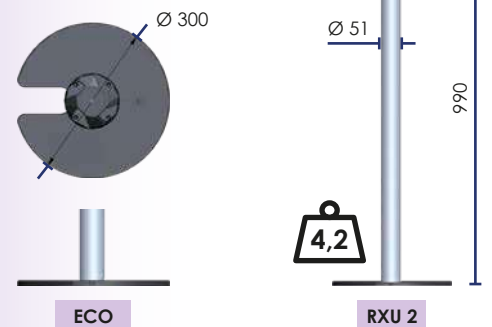

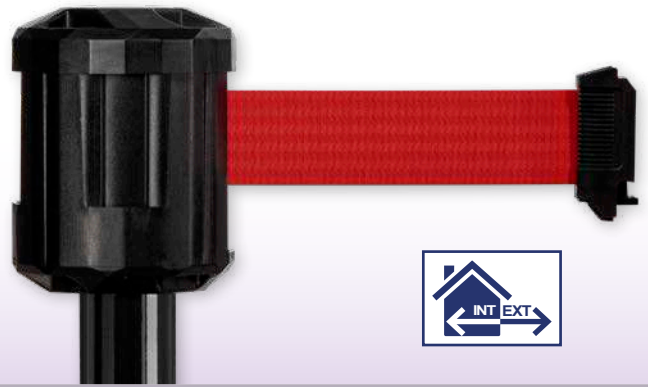

**COULEUR SANGLE** o BELT COLOR  
 COLOR CINTA o GURT-FARBE

2 M X 50 MM  
 4 M X 50 MM

4 M X 100 MM

10 M X 50 MM

10 M X 100 MM

Sangle freinée  
 Braked strap  
 Cinta frenada  
 Absperrgurt mit  
 Bremsvorrichtung



**BASE FIXE** o FIXED BASE  
 BASE FIJA  
 BODENBEFESTIGUNG FEST

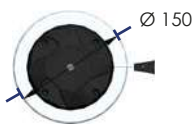

FIX

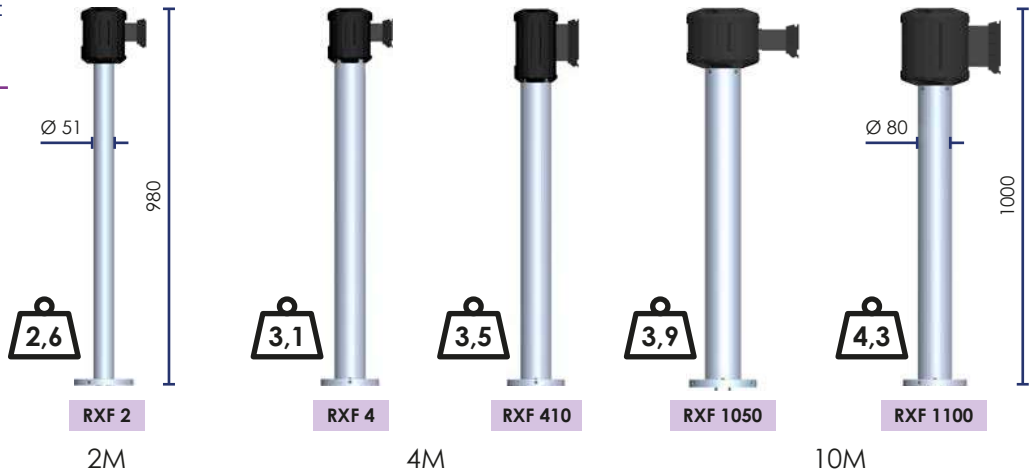

**AMOVIBLE** \* o REMOVABLE  
 EXTRAÍBLE o ABNEHMBAR

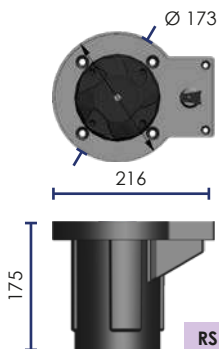

RS BOX

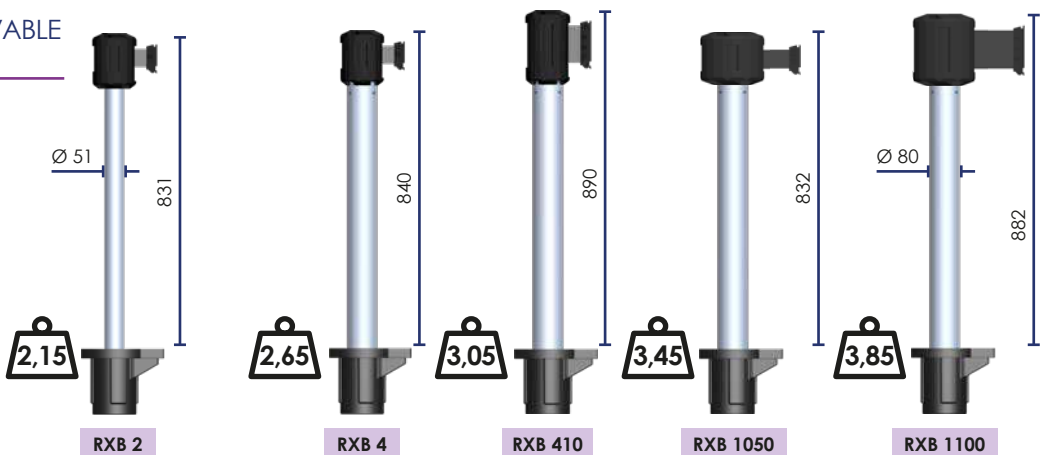

\* Poteau amovible o Removable post o Poste extraíble o Abnehmbarer Pfosten

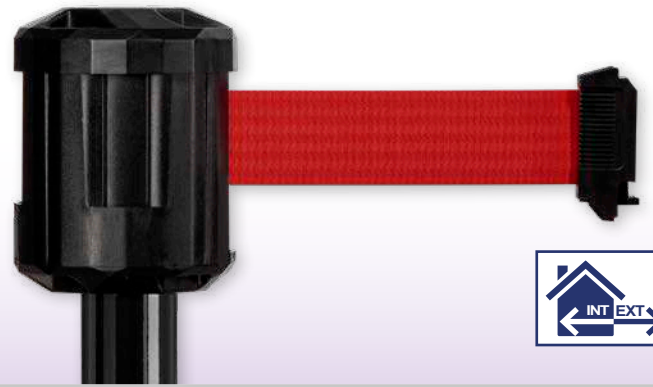

**ROULETTES** WHEELS  
**RUEDAS** RUNDERFUSS

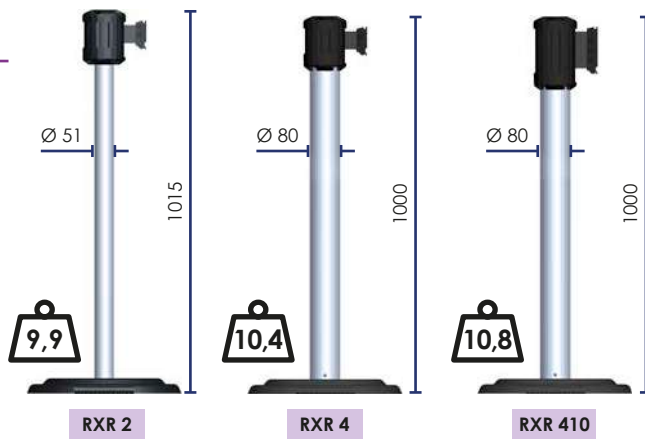

**HEAVY**



**À LESTER** TO BE LOADED  
**LASTRABLE** BEFÜLBAR

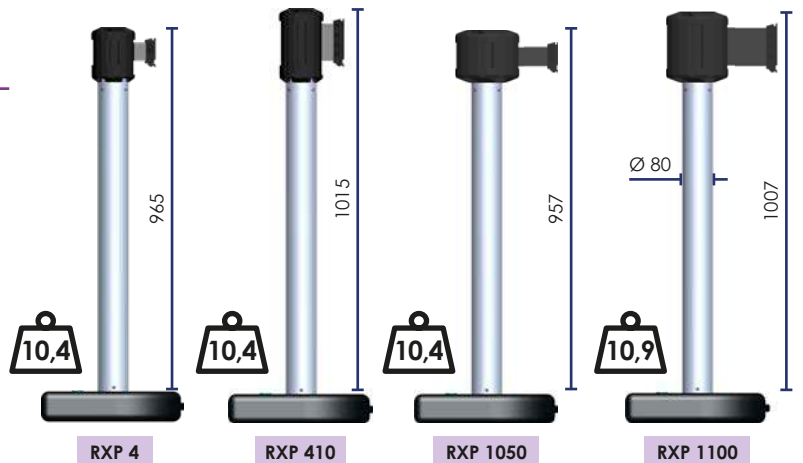



RWX

**ENROULEUR MURAL** o **WALL MOUNTED BARRIER**  
**ENROLLADOR MURAL DE CINTA** o **WANDAUFROLLER**



- Enrouleur mural à sangle pour limiter facilement l'accès à une zone
- Boîtier ABS étanche
- Sangle freinée
- Tête orientable
- Récepteur mural, kit aimanté et fixations inclus

- Wall-mounted retractable belt to easily limit access to an area
- Water-resistant ABS box
- Braked strap
- Adjustable head
- Wall receiver, magnets kit and fixings included

- Enrollador mural de cinta para limitar fácilmente el acceso a un área
- Caja ABS resistente al agua
- Cinta con freno
- Cabezal ajustable
- Receptor de pared, kit de imanes y fijaciones incluidos

- Durch den Wandaufroller kann der Zugang für bestimmte Bereiche eingeschränkt werden
- Wasserdichtes ABS-Gehäuse
- Absperrgurt mit Bremsvorrichtung
- Verstellbarer Kopf
- Einhängenvorrichtung, Magnetset und Befestigungen enthalten

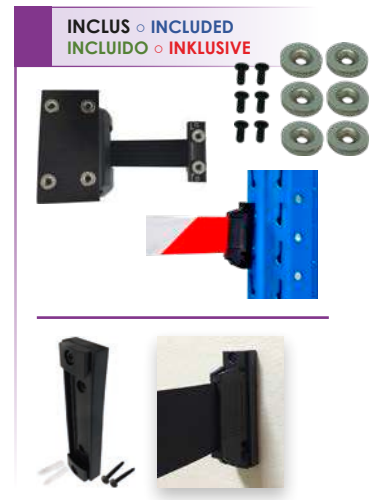
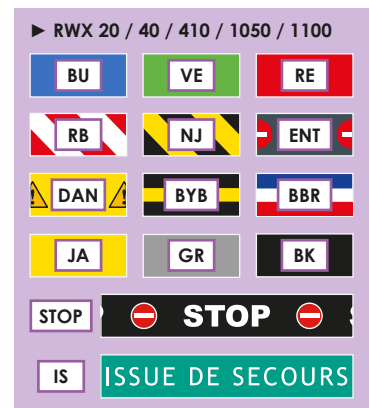
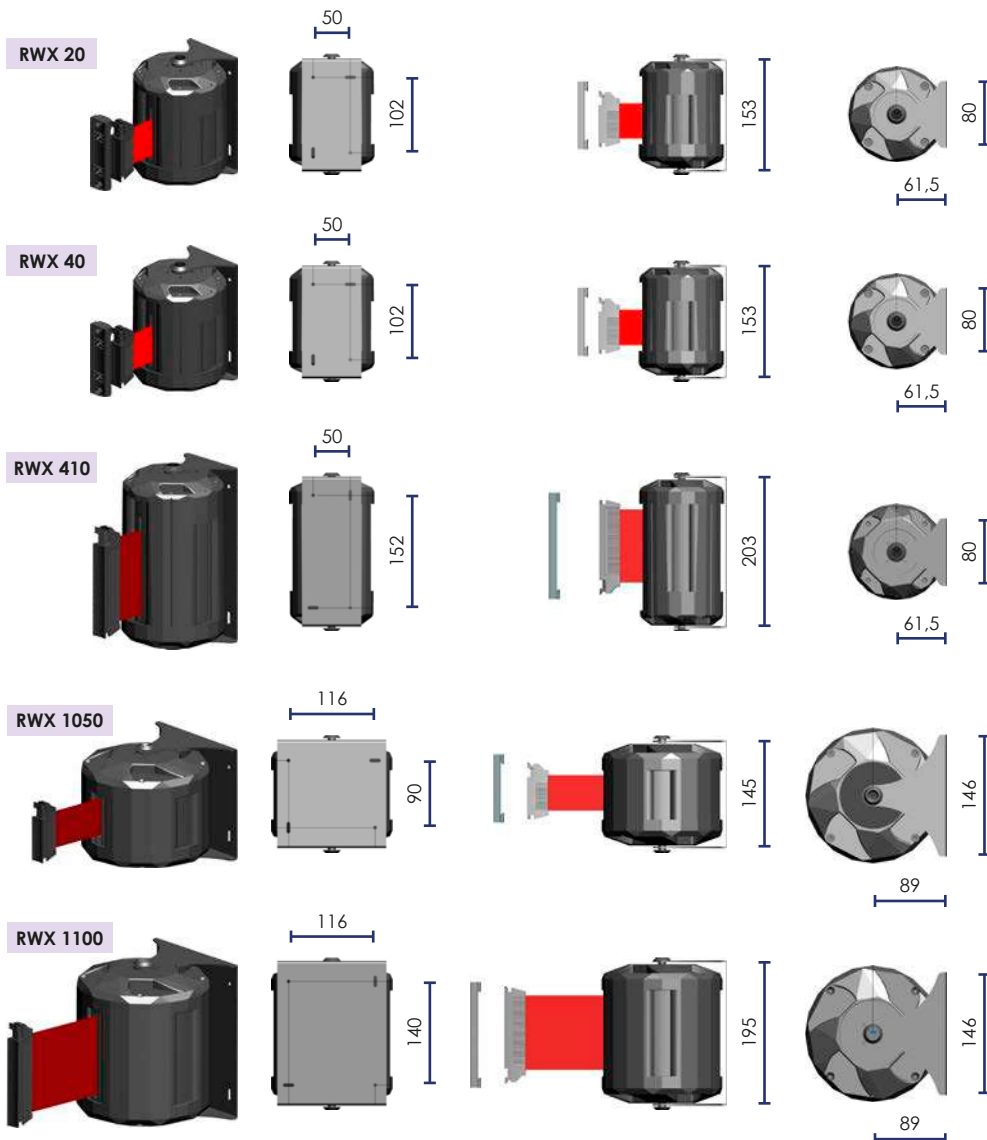



# POTEAUX D'INFORMATION

INFORMATION POST ◦ POSTE DE INFORMACIÓN  
INFO STÄNDER



	Code	
	RS 160 BK RS 160 SR	● ●
	RSF 160 BK RSF 160 SR	● ●
	RSLO 160 BK RSLO 160 SR	● ●
	RSP 160 BK RSP 160 SR	● ●
	RSB 160 BK RSB 160 SR	● ●

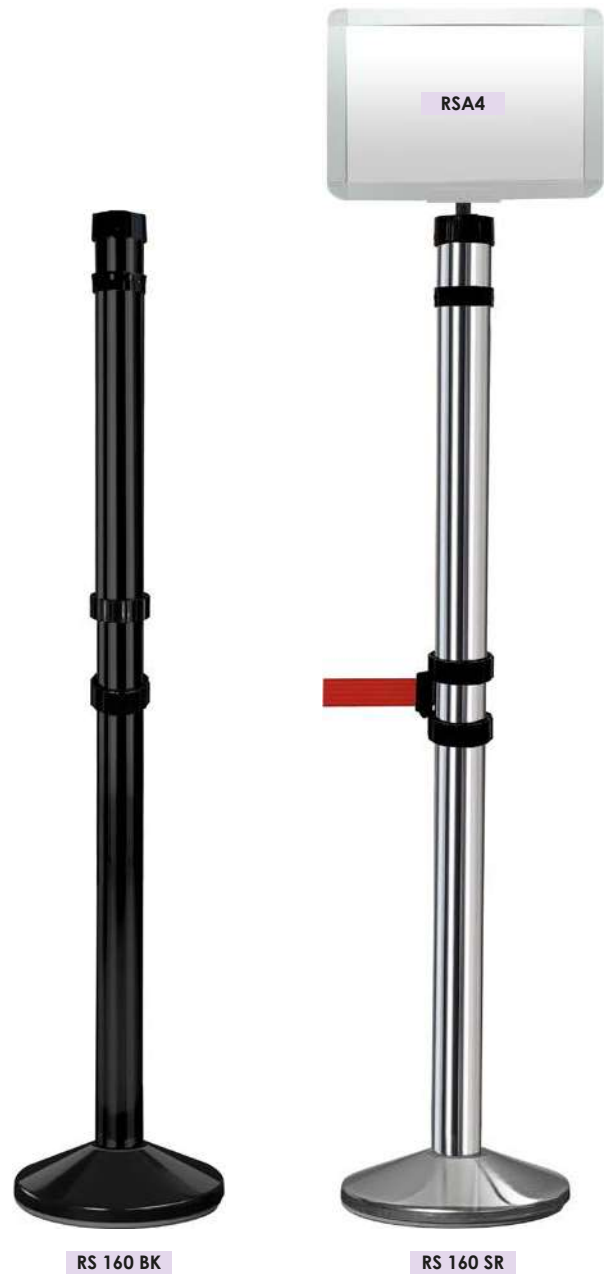
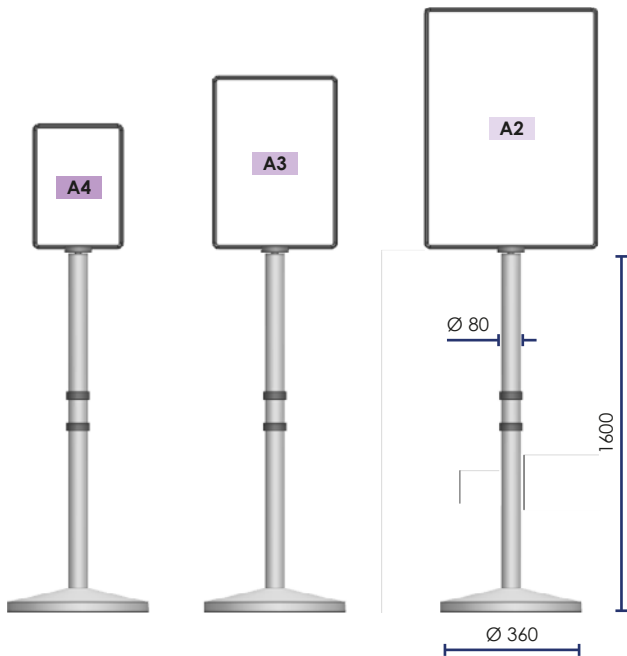
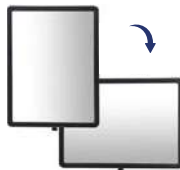

OPTION ◦ OPTIONAL ◦ OPCIÓN ◦ OPTIONAL ▶ p. 221





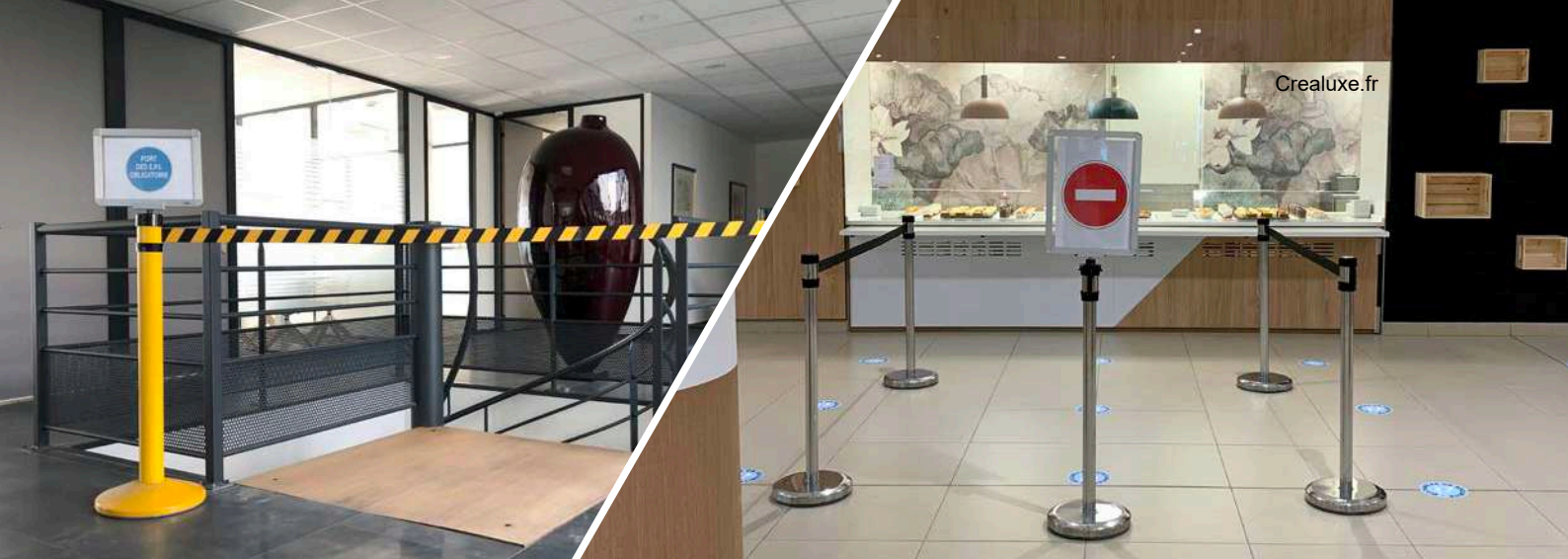

## ACCESSOIRES D'INFORMATION

SIGN HOLDERS ◦ PORTA CARTELES

ZUBEHÖR FÜR INFO STÄNDER



• La tête filetée de nos poteaux permet d'accrocher différents panneaux d'informations.

• The threaded head of our posts can be used to hold different information panels.

• La cabeza roscada de nuestros postes permite colocar distintos formatos de carteles.

• Die Gewindeaufnahme im Pfosten ermöglicht dieschnelle Aufnahme (Wechsel) von diversen Info-Tafel

Code		
RSA4 PN	●	0,54
RSA3 PN	●	0,98
RSA4 G	●	0,54
RSA3 G	●	0,98

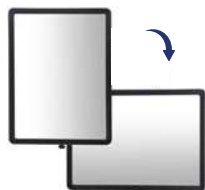

RSA4 PN



RSA3 PN



RSA4 G

Code		
RSA4	●	0,84
RSA3	●	1,15
RSA2	●	1,83



RSA4



RSA3

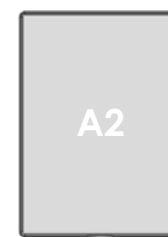

RSA2

Résistant à l'eau  
Water-resistant  
Resistente al agua  
Spritzwasser geschützt

Porte-affiche Aluminium orientable  
Aluminum sign holder multiposition  
Soporte ajustable de aluminio  
Verstellbarer Posterhalter aus Aluminium

Code		
RSA4 ROT	●	0,96
RSA3 ROT	●	1,39
RSA2 ROT	●	2,28



RSA4 ROT

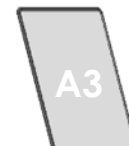

RSA3 ROT

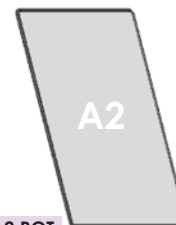

RSA2 ROT



- Affichage multi positions
- Utilisation intérieure et extérieure
- Multi-position display
- Indoor and outdoor use
- Porta-cartel multi-posición
- Uso en interior y en exterior
- Multipositionsanzeige
- Verwendung im Innen- und Außenbereich



## ACCESSOIRES ◦ ACCESSORIES ◦ ACCESORIOS ◦ ZUBEHÖR

### CONNECTEUR DE SANGLE ◦ BELT CONNECTOR CONECTOR DE CINTA ◦ GURTVERBINDER

Code	H Sangle Belt ◦ Cinta ◦ Gurt	
WRE CONNECT SB	50 mm	92 x 15
WRE 100 CONNECT	100 mm	144 x 15



### KIT FIXATION MAGNÉTIQUE ◦ MAGNETIC MOUNTING KIT KIT DE MONTAJE MAGNÉTICO ◦ HALTERUNGSATZ MIT MAGNET

- Kit composé de 6 aimants, livré avec la visserie : 2 aimants sont à poser sur l'attache murale et 4 sur le support mural de l'enrouleur.
- Kit including 6 magnets, delivered with fixings: 2 magnets are to be placed on the wall receiver and 4 on the belt frame.

- Kit compuesto de 6 imanes, suministrado con fijaciones: 2 imanes para colocar en el receptor de pared y 4 en el marco de la cinta.
- Satz besteht aus 6 Magneten inkl. Schrauben, 2 Magnete f. Wandhalterung / 4 Magnete f. Aufroller



### RÉCEPTEUR MURAL DE SANGLE ◦ BELT WALL RECEIVER RECEPTOR MURAL DE CINTA ◦ WANDHALTERUNG

Code	H Sangle Belt ◦ Cinta ◦ Gurt	
WRE SB	50 mm	92 x 15
WRE 100 SB	100 mm	144 x 15



### ADAPTATEUR UNIVERSEL UNIVERSAL ADAPTER ADAPTADOR UNIVERSAL UNIVERSAL ADAPTER

Code	H Sangle Belt ◦ Cinta ◦ Gurt
WRAD SB	50 mm



- Permet un raccordement avec les poteaux d'autres marques. Nous consulter.
- Allows connection with posts of other brands. Contact us.
- Permite la conexión con postes de otras marcas. Consultarnos.
- Ermöglicht die Verbindung mit Pfosten von anderer Fabrikaten. Wir bitten Rücksprache.

### FIXATION AUTOUR D'UN POTEAU FIXATION AROUND A POST FIJACIÓN ALREDEDOR DE UN POSTE BEFESTIGUNG UM EINEN PFOSTEN

Code	H Sangle Belt ◦ Cinta ◦ Gurt
WR 10 SB	50 mm





# TROLLEY 6 / 9

## CHARIOT TRANSPORT POTEAU ○ POST TROLLEY CARRO DE TRANSPORTE PARA POSTES ○ TRANSPORTWAGEN F. PFOSTEN

Code	kg
TROLLEY 9	50
TROLLEY 9 EXT	47
TROLLEY 6	38
TROLLEY 6 EXT	35

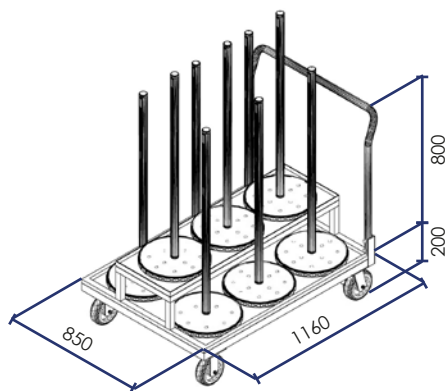

TROLLEY 9 EXT

TROLLEY 9 EXT

TROLLEY 9

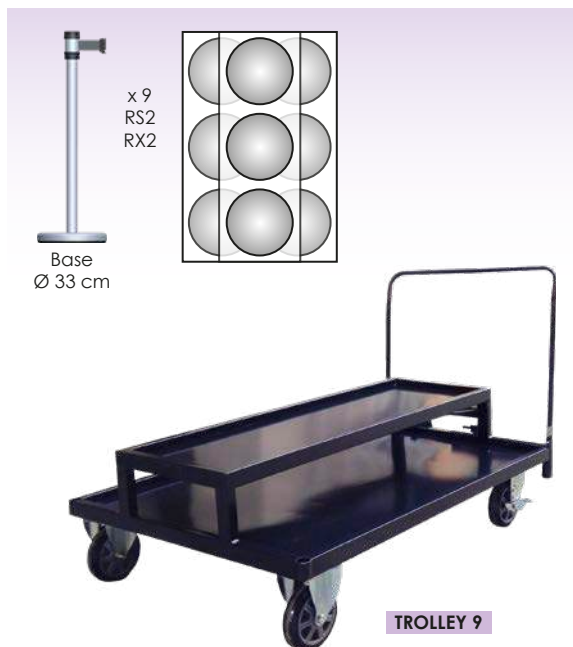

2 roues pivotantes avec frein  
2 swivel wheels with brakes  
2 ruedas giratorias con freno  
2 Schwenkräder mit Bremse



2 roues fixes  
2 fixed wheels  
2 ruedas fijas  
2 Räder fest



Capuchons cache trous  
Caps for hiding holes  
Tapones ciegos  
Abdeckkappen



Liaison chariot  
Trolley link  
Enlace para carros  
Anhänger Vorrichtung



Poignée ergonomique  
Ergonomic handle  
Mango ergonómico  
Ergonomische Griffe





A series of horizontal lines for writing notes, starting from the top of the page and extending down to the bottom.





# RECO / REDO

## POTEAU DE GUIDAGE À SANGLE ○ RETRACTABLE BELT STANCHION POSTE CON CINTA ○ PERSONNENLEITSYSTEM



- Permet d'interdire facilement l'entrée d'une zone, délimiter des accès ou guider les personnes dans la file d'attente.
- Sangle de 3 m, largeur 50 mm.
- **Usage recommandé en intérieur.** Occasionnel en extérieur mais pas sous la pluie.
- In order to easily forbid the access of an area.
- 3 m belt, width 50 mm.
- **Indoor use recommended.** Outdoor use occasionally but not under the rain.
- Permite prohibir la entrada a una zona, delimitar los accesos o guiar a las personas en la cola.
- 3 m de correa, anchura 50 mm.
- **Recomendado para uso en interiores.** Uso ocasional en el exterior pero no en la lluvia.
- Einfache Regelung der Zugangsbereiche.
- Gurtlänge 3 m, Breite 50 mm.
- **Empfohlen f. Innenbereich.** Gelegentliche Außenbenutzung möglich, jedoch nicht regentauglich.

	RECO 2 BK BK	RECO 2 SR BK	RECO 2 LA BK			
	RECO 2 BK RE	RECO 2 SR RE	RECO 2 LA RE			
	RECO 2 BK BU	RECO 2 SR BU	RECO 2 LA BU			
	RECO 2 BK JA	RECO 2 SR JA	RECO 2 LA JA			
	RECO 2 BK NJ	RECO 2 SR NJ	RECO 2 LA NJ			
	RECO 2 BK RB	RECO 2 SR RB	RECO 2 LA RB			

La tête peut recevoir 3 sangles  
Head can receive 3 belts  
Cabeza puede recibir 3 cintas  
Pfosten verfügt über 3 weitere Gurtaufnahmen

RECO 2

RECO 2 BK RE

RECO 2 SR BK

RECO 2 LA RE

	RECO 22 BK BK	RECO 22 SR BK	RECO 22 LA BK			
	RECO 22 BK RE	RECO 22 SR RE	RECO 22 LA RE			
	RECO 22 BK BU	RECO 22 SR BU	RECO 22 LA BU			
	RECO 22 BK JA	RECO 22 SR JA	RECO 22 LA JA			
	RECO 22 BK NJ	RECO 22 SR NJ	RECO 22 LA NJ			
	RECO 22 BK RB	RECO 22 SR RB	RECO 22 LA RB			

RECO 22

RECO 22 LA RE

	REDO 4 BK BK	REDO 4 SR RE	REDO 4 NJ NJ	REDO 4 RB RB

REDO 4

REDO 4 BK BK

REDO 4 SR RE

REDO 4 NJ NJ

REDO 4 RB RB

# REWO 20

## ENROULEUR MURAL ◦ WALL MOUNTED RECEIVER ENROLLADOR MURAL DE CINTA ◦ WANDKASSETTE



- Permet d'interdire facilement l'entrée d'une zone, délimiter des accès.
- Sangle 3 m, largeur 50 mm.
- Récepteur mural inclus.
- Fixations incluses.

- In order to easily forbid the access of an area.
- Strap 3 m, width 50 mm.
- Wall-mounted receiver included.
- Fixations included.

- Facilita prohibir la entrada a una zona, delimitar los accesos o guiar a las personas en la cola.
- Correa de 3 m, anchura 50 mm.
- Incluye un receptor de pared.
- Se incluyen soportes de montaje.

- Einfaches absperrn des Zugangs zu einem Bereich.
- Bandlänge 3 m, Breite 50 mm.
- Wandclip im Lieferumfang enthalten.
- Inkl. Befestigungsmaterial.

Code	
REWO 20 BK	
REWO 20 RE	
REWO 20 BU	
REWO 20 JA	
REWO 20 NJ	
REWO 20 RB	



REWO 20 BK

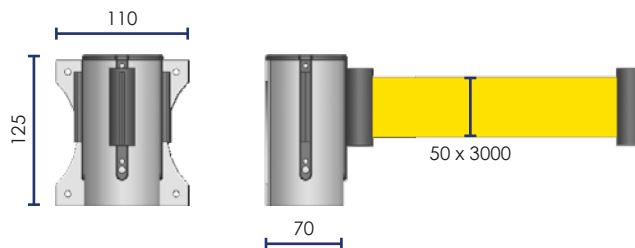

### INCLUS ◦ INCLUDED ◦ INCLUIDO ◦ INKLUSIVE



Accroche murale  
Wall-mounted receiver  
Receptor de pared  
Wandbefestigungsplatte

WR 24 SB

## ACCESSOIRES ◦ ACCESSORIES ◦ ACCESORIOS ◦ ZUBEHÖR

### KIT FIXATION MAGNÉTIQUE ◦ MAGNETIC MOUNTING KIT KIT DE MONTAJE MAGNÉTICO ◦ BEFESTIGUNGSSET MAGNETISCH

- Kit composé de 6 aimants, livré avec la visserie : 2 aimants sont à poser sur l'attache murale et 4 sur le support mural de l'enrouleur.
- Kit including 6 magnets, delivered with fixings: 2 magnets are to be placed on the wall receiver and 4 on the belt frame.
- Kit compuesto de 6 imanes, suministrado con fijaciones: 2 imanes para colocar en el receptor de pared y 4 en el marco de la cinta.
- Satz besteht aus 6 Magneten inkl. Schrauben, 2 Magnete f. Wandhalterung / 4 Magnete f. Aufroller



WR 6 SB

### PORTE AFFICHE ◦ SIGN HOLDER PORTA AFICHE ◦ INFORMATIONSTAFEL



RECO A4P BK

Code		
RECO A4P BK		
RECO A3P BK		
RECO A4P GO		
RECO A3P GO		
RECO A4P CH		
RECO A3P CH		

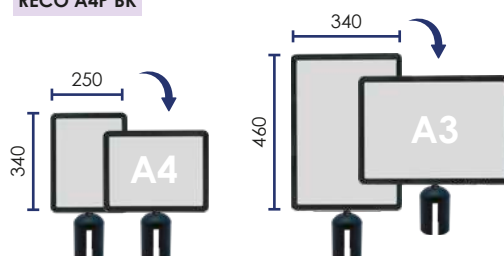

### ACCROCHE MURALE WALL-MOUNTED RECEIVER RECEPTOR DE PARED WANDBEFESTIGUNGSPLATTE



WR 24 SB

En option pour les poteaux à sangle  
Optional with retractable belt stanchion  
Opcional con el poste con cinta  
Optional für Gurtpfosten

NOTES



A series of horizontal lines for writing notes, starting from the top line below the pencil icon and extending down to the bottom of the page.





GO! SML WEIBO

STICKY MONSTER LAB

MONSTERS



SMART

## POTEAU DE GUIDAGE À SANGLE

### RETRACTABLE BELT STANCHION ◦ POSTE CON CINTA

### PERSONNENLEITSYSTEM



- Usage recommandé en intérieur. Occasionnel en extérieur mais pas sous la pluie.
- Indoor use recommended. Outdoor use occasionally but not under the rain.
- Recomendado para uso en interiores. Uso ocasional en el exterior pero no en la lluvia.
- Empfohlen f. Innenbereich. Gelegentliche Außenbenutzung möglich, jedoch nicht regentauglich.
- Sangle de 2 m, largeur 30 mm.
- 2 m belt, width 30 mm.
- 2 m de cinta, ancho 30 mm.
- Gurtlänge 2m, Breite 30 mm.

●	SMART 55 BK BK	SMART 55 SR BK
●	SMART 55 BK RE	SMART 55 SR RE
●	SMART 85 BK BK	SMART 85 SR BK
●	SMART 85 BK RE	SMART 85 SR RE

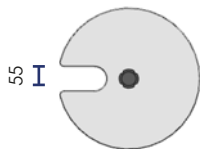

	●	RWSMART BK
	●	RWSMART RE



#### OPTION ◦ OPTIONAL ◦ OPCIÓN ◦ OPTIONAL

Code	
SMART A4 PN	
SMART A3 PN	
SMART A4	
SMART A3	



Adaptateur  
Connector  
Adaptador  
Adapter

#### INCLUS ◦ INCLUDED INCLUIDO ◦ INKLUSIVE



Base lestée + patin de protection  
Weighted base with foam  
Base pesada con protecciones  
Basisplatte + Schutzpolster



RMU

## POTEAU DE DÉLIMITATION POUR CORDE ÉLASTIQUE

GUIDING POST WITH ELASTIC CORD ◦ POSTE CON CUERDA ELÁSTICA

BEGRENZUNGSPFOSTEN FÜR ELASTISCHES SEIL



- Usage recommandé en intérieur.  
Occasionnel en extérieur mais pas sous la pluie.
- Indoor use recommended.  
Outdoor use occasionally but not under the rain.

- Recomendado para uso en interiores.  
Uso ocasional en el exterior pero no en la lluvia.
- Empfohlen f. Innenbereich. Gelegentliche  
Außenbenutzung möglich, jedoch nicht regentauglich.

Code	
RMU 500	
RMU 850	
RMU 500 BK	
RMU 850 BK	

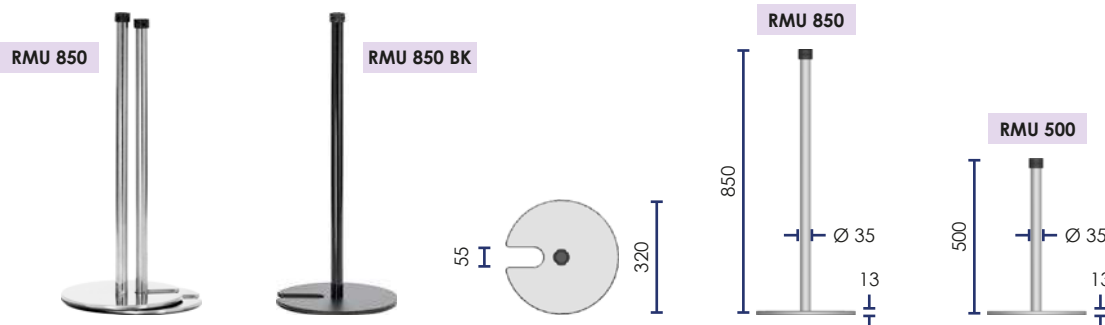

## CORDE ÉLASTIQUE ◦ ELASTIC CORD ◦ CUERDA ELÁSTICA ◦ GUMMIBAND

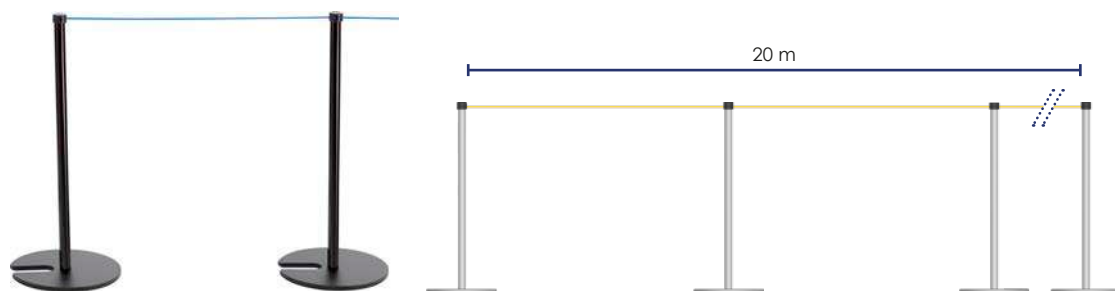

OPTION ◦ OPTIONAL ◦ OPCIÓN ◦ OPTIONAL

Code	
RMU A4 PN	
RMU A3 PN	
RMU A4 ALU	
RMU A3 ALU	



INCLUS ◦ INCLUDED  
INCLUIDO ◦ INKLUSIVE



Base lestée + patin de protection  
Weighted base with foam  
Base pesada con protecciones  
Basisplatte + Schutzpolster



## POTEAU DE DÉLIMITATION POUR CORDE ET CHAÎNE

### GUIDING POST WITH CHAIN OR ROPE ◦ POSTE CON CUERDA O CADENA

### PFOSTEN (PERSONENLEITSYSTEM) FÜR SEIL ODER KETTE



Code	
SMART 55 SR	
SMART 85 SR	
SMART 55 BK	
SMART 85 BK	



- Usage recommandé en intérieur. Occasionnel en extérieur mais pas sous la pluie.
- Indoor use recommended. Outdoor use occasionally but not under the rain.
- Recomendado para uso en interiores. Uso ocasional en el exterior pero no en la lluvia.
- Empfohlen f. Innenbereich. Gelegentliche Außenbenutzung möglich, jedoch nicht regentauglich.

## CORDE TRESSÉE ◦ BRAIDED ROPE

### CUERDA TRENZADA ◦ KORDEL GEFLOCHTEN

Code		
CI 2 C		
CI 2 G		
CI 2 BLE N		
CI 2 BLE		
CI 2 RN		
CI 2 R		
CI 2 NN		
CI 2 N		
CI 2 BBR N		
CI 2 BBR		



## CORDE VELOURS ◦ VELVET ROPE

### CUERDA DE TERCIPELO ◦ SAMT / VELOURSKORDEL

Code		
REZO 150 BK SR		
REZO 150 BK LA		
REZO 150 RE SR		
REZO 150 RE LA		



## CHAÎNE ACIER ◦ STEEL CHAIN ◦ CADENA DE ACERO ◦ STAHLKETTEN

Code	
CDCH 252 SB	
CDN 252 SB	

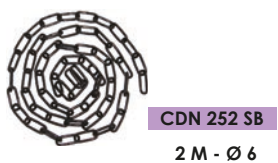
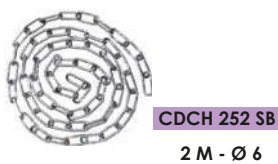

INCLUS ◦ INCLUDED ◦ INCLUIDO ◦ INKLUSIVE



Autres couleurs ► p. 188 ◦ Other color ► p. 188 ◦ Otros colores ► p. 188 ◦ Andere Farben ► p. 188



PRINTEMPS  
MODE

PRINTEMPS



REXO 100

## POTEAU DE GUIDAGE POUR CORDE OU CHAÎNE

### GUIDING POST WITH CHAIN OR ROPE ○ POSTE CON CUERDA O CADENA

### PPOSTEN (PERSONENLEITSYSTEM) FÜR SEIL ODER KETTE



- Usage recommandé en intérieur.  
Occasionnel en extérieur mais pas sous la pluie.
- Indoor use recommended.  
Outdoor use occasionally but not under the rain.

- Recomendado para uso en interiores.  
Uso ocasional en el exterior pero no en la lluvia.
- Empfohlen f. Innenbereich. Gelegentliche  
Außenbenutzung möglich, jedoch nicht regentauglich.



Code	
REXO 100 CHC	
REXO 100 BKC	
REXO 100 LAC	



REXO 100 BKC



REXO 100 CHC



REXO 100 LAC

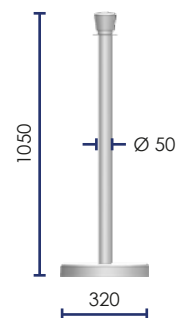

Code	
REXO 100 CHR	
REXO 100 BKR	
REXO 100 LAR	



REXO 100 BKR



REXO 100 CHR



REXO 100 LAR

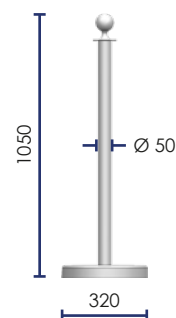

## PORTE AFFICHE ○ SIGN HOLDER

### PORTA AFICHE ○ INFORMATIONSTAFEL



Code		
REXO 4 PN		ABS
REXO 3 PN		ABS
REXO 4 ALU		alu
REXO 3 ALU		alu
REXO 4 G		ABS
REXO 3 G		ABS

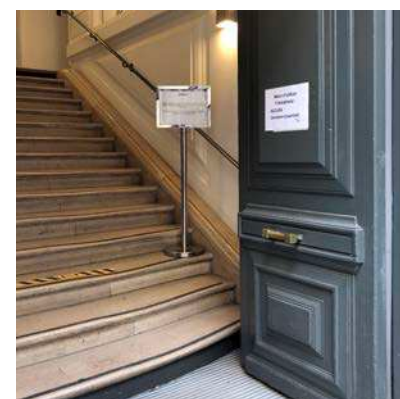
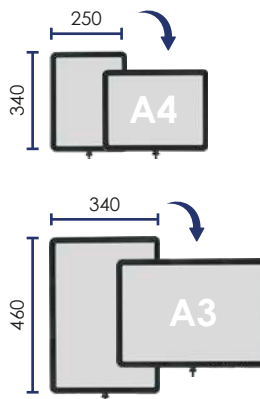



REXO 2 / 22

# POTEAUX DE GUIDAGE À CORDE

## GUIDING POST WITH ROPE

### POSTE CON CUERDA

### KORDELSTÄNDER



- Usage recommandé en intérieur.  
Occasionnel en extérieur mais pas sous la pluie.
- Indoor use recommended.  
Outdoor use occasionally but not under the rain.

- Recomendado para uso en interiores.  
Uso ocasional en el exterior pero no en la lluvia.
- Empfohlen f. Innenbereich. Gelegentliche  
Außenbenutzung möglich, jedoch nicht regentauglich.



1,60 M - Ø 30

Corde velours  
Velvet rope  
Cuerda de terciopelo  
Samt / Velourskordel



REXO 22 LAI BK



REXO 22 SR BK



REXO 22 BK RE

	REXO 22 BK BK	REXO 22 SR BK	REXO 22 LAI BK
	REXO 22 BK RE	REXO 22 SR RE	REXO 22 LAI RE

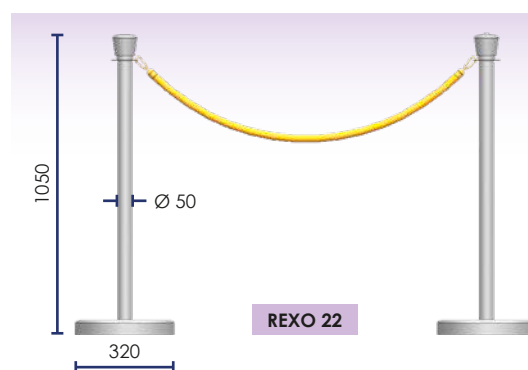

REXO 22

	REXO 2 BK BK	REXO 2 SR BK	REXO 2 LAI BK
	REXO 2 BK RE	REXO 2 SR RE	REXO 2 LAI RE

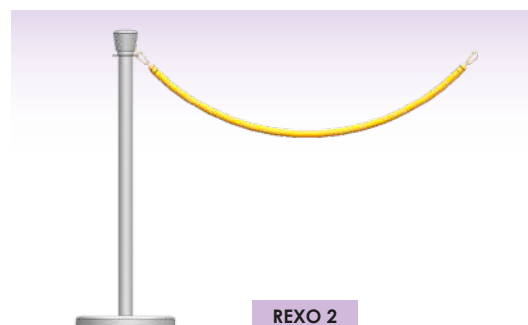

REXO 2



## CORDE TRESSÉE

BRAIDED ROPE ◦ CUERDA TRENZADA ◦ KORDEL GEFLOCHTEN



Code		
CI 2 BLE L		
CI 2 BLE		
CI 2 G		
CI 2 R L		
CI 2 R		
CI 2 N L		
CI 2 N		
CI 2 BBR L		
CI 2 BBR		



CI 2 BLE

2 M - Ø 30



CI 2 BBR



## CORDE VELOURS

VELVET ROPE ◦ CUERDA DE TERCIOPELO ◦ KORDEL MIT SAMT

Code		
REZO 150 BK SR		
REZO 150 BK LA		
REZO 150 RE SR		
REZO 150 RE LA		



1,60 M - Ø 30

REZO 150 RE LA



REZO 150 BK SR



## CORDE TORSADES

TWISTED ROPE ◦ CUERDA TORCIDA ◦ FLECHTSEIL

Code	
CI 2 C L	
CI 2 C	



CI 2 C



## ACCROCHE MURALE

WALL RECEIVER ◦ RECEPTOR DE PARED ◦ WANDHALTERUNG

Code	
ATC 01 SB	
ATL 01 SB	

ATC 01 SB



ATL 01 SB







## REXO 60

### POTEAU POUR CORDE FILANTE

POST FOR ROPE ◦ POSTE PARA CUERDA

STÄNDER FÜR KORDEL



REXO 60 BK



REXO 60 CH



REXO 60 LA

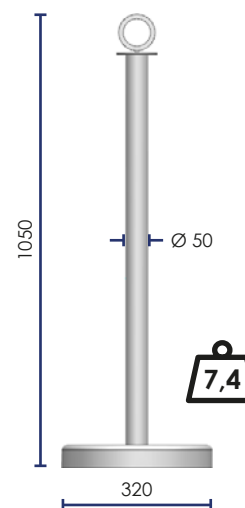

### CORDE 10 M

ROPE ◦ CUERDA ◦ SEIL

Code	
REZO 100 RED	
REZO 100 BLACK	
REZO 100 ECRU	

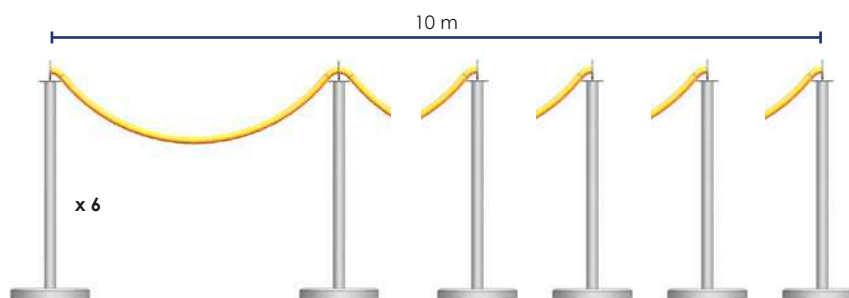

10 M - Ø 32



10 M - Ø 32



10 M - Ø 32



# REXO CHAIN

## POTEAUX DE GUIDAGE AVEC CHAÎNE

GUIDING POSTS WITH CHAIN ◦ POSTES CON CADENA

ABSPERRPFOSTEN MIT KETTE



REXO CHAIN 2 CH	REXO CHAIN 2 BK	REXO CHAIN 2 LA	
REXO CHAIN 1 CH	REXO CHAIN 1 BK	REXO CHAIN 1 LA	

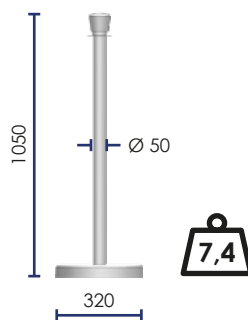
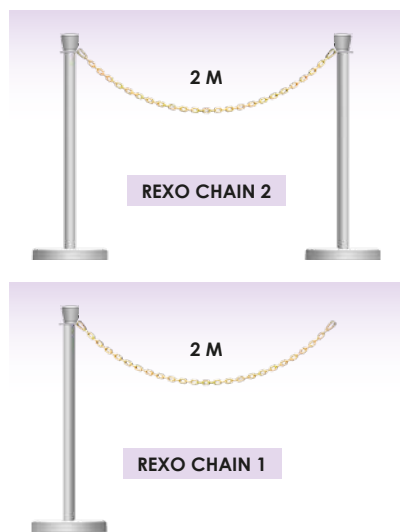

## ACCESSOIRES ◦ ACCESSORIES ◦ ACCESORIOS ◦ ZUBEHÖR

CDCH 252 SB  
2 M - Ø 6



CDN 252 SB  
2 M - Ø 6



CDGO 252 SB  
2 M - Ø 6



► p. 234



## REXO BACH

### KIT POTEAUX AVEC BÂCHE PERSONNALISÉE POSTS AND CUSTOMIZED TARPULIN ◦ POSTES CON LONA PERSONALIZADA STÄNDER SATZ MIT KUNDENINDIVIDUELLEN PLANE



- Bâche avec fourreau - traitée anti UV
- Tarpaulin with scabbard - UV resistant
- Lona con funda - Resistente a los UV
- Plane mit Aufbewahrungsfutteral - UV beständig

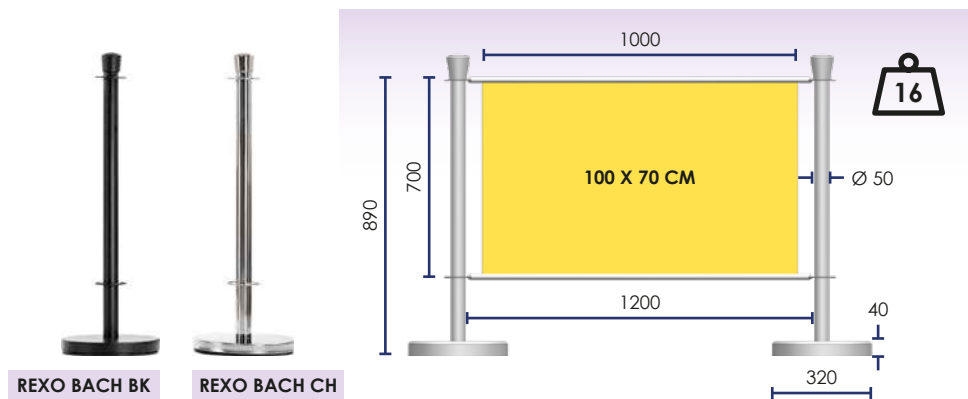

REXO BACH 2 BK



REXO BACH 1 BK



REXO BACH 2 CH



REXO BACH 1 CH

#### OPTION ◦ OPTIONAL ◦ OPCIÓN ◦ OPTIONAL



Code	
REXO 4 PN	
REXO 3 PN	
REXO 4 ALU	
REXO 3 ALU	

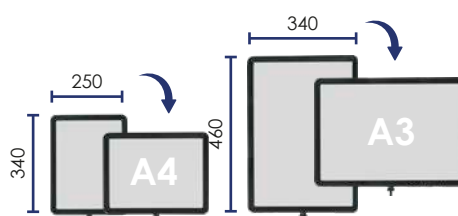

Bâche brise vent microperforée  
Microperforation wind break tarpaulin  
Lona cortavientos microperforada  
Mikroperforierte Windschutzhülle





**KIT POTEAUX AVEC PANNEAU PERSONNALISÉ**  
**POSTS AND CUSTOMIZED PANEL** ◦ **POSTES CON PANEL PERSONALIZADO**  
**PFOSTEN SATZ MIT INDIVIDUELLEN KUNDEN PANEL**

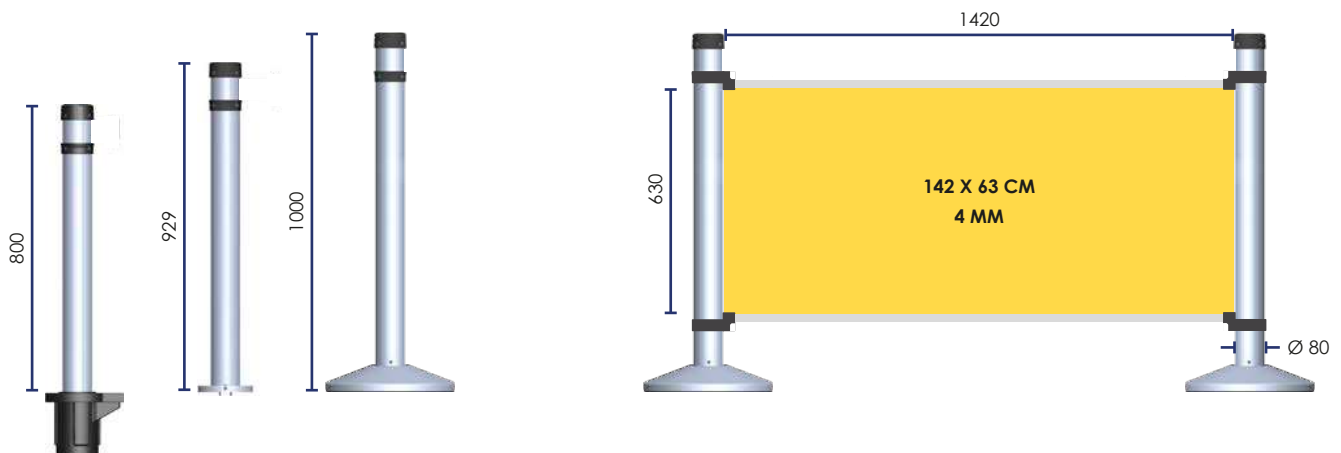

Type base ► p. 212 - 213  
 Base type  
 Tipo base  
 Bodenhülse



**RS 4 RING**

Bagues de fixations  
 Fixations rings  
 Anillo de fijación  
 Befestigungsring



**RS 4 BAR**

Rails pour panneau  
 Panel rails  
 Rieles para panel  
 Führungsschiene für Panel



**RS 4 PNX**

Panneau personnalisé  
 Customized panel  
 Panel personalizado  
 Individueller Kunden Panel

142 x 63 cm / 4 mm

**COULEUR POTEAU** ◦ **POST COLOR**  
**COLOR POSTE** ◦ **PFOSTEN FARBVARIANTEN**



**OPTION** ◦ **OPTIONAL** ◦ **OPCIÓN** ◦ **OPTIONAL** ► p. 221





# BAR- KIT



## KIT POTEAUX AVEC BARRIÈRES ◦ POSTS WITH BARRIERS POSTES CON BARRERAS ◦ SET ABSPERRUNG MIT LATTEN

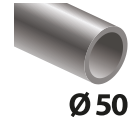

Code		
BAR-CH KIT		19
BAR-BK KIT		
BAR-CH EXT		9,5
BAR-BK EXT		

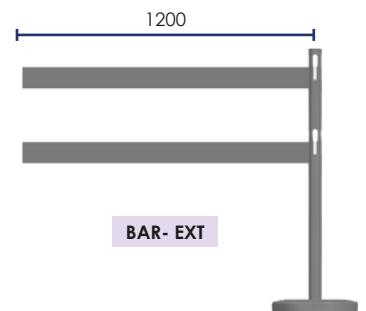
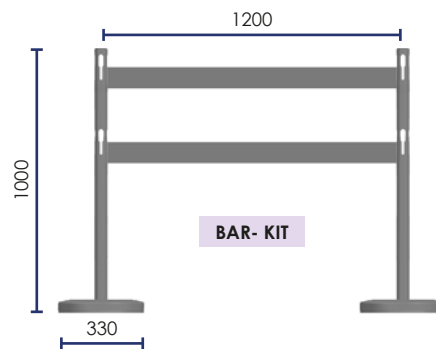

Code		
BSA 100 AISI		8
BSA 100 N		

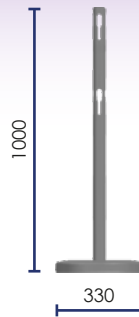

Code		
BSA 1202 ZG		2,7
BSA 1202 N		

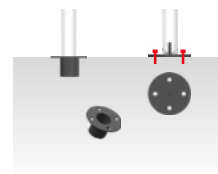
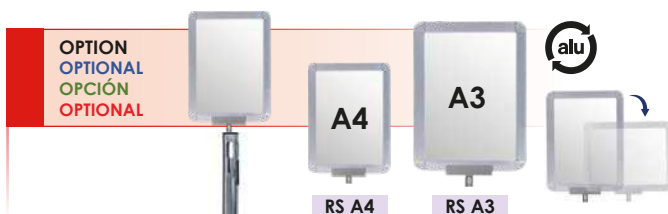

Fixation dans le sol ▶ p. 183  
Ground fixing ▶ p. 183  
Fijación al suelo ▶ p. 183  
Boden Befestigung ▶ p. 183

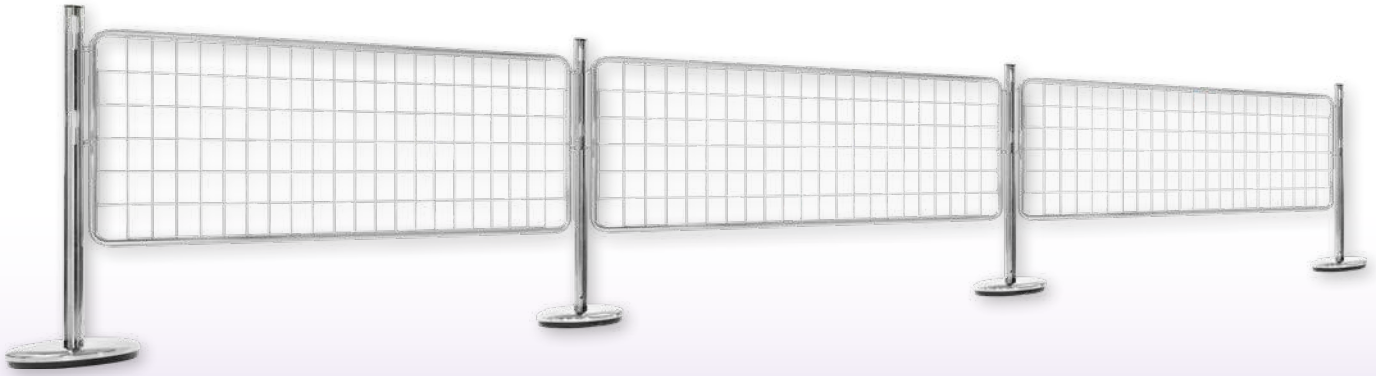

## GRI KIT

### KIT POTEAUX AVEC GRILLE

POSTS WITH FENCE

POSTES CON REJA ○ SET ABSPERRUNG MIT GITTER

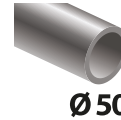

Code	
GRI CH KIT	
GRI BK KIT	
GRI CH EXT	
GRI BK EXT	

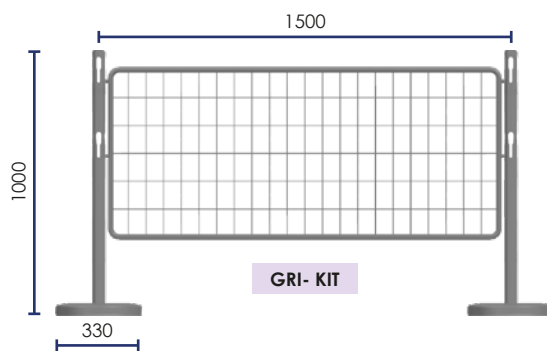

GRI- KIT

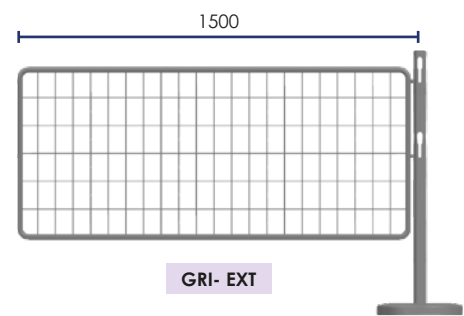

GRI- EXT

Code	
BSA 100 AISI	
BSA 100 N	

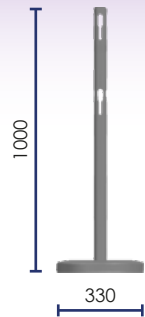

BSA 100 AISI

BSA 100 N



Code	
B 1500 ZG	
B 1500 N	

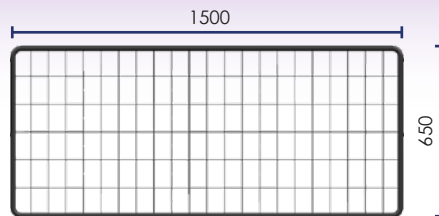

B1500



OPTION  
OPTIONAL  
OPCIÓN  
OPTIONAL



RS A3

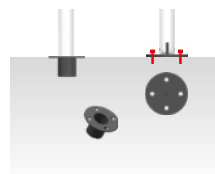

Fixation dans le sol ► p. 183  
Ground fixing ► p. 183  
Fijación al suelo ► p. 183  
Boden Befestigung ► p. 183



# KIT DE GUIDAGE PLASTIQUE

## PLASTIC GUIDING KIT ◦ KIT DE GUIADO DE PLÁSTICO

### ABSPERRUNGSSET AUS KUNSTSTOFF

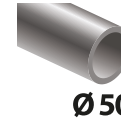

Code		
CBR SET N	●	●
CBR SET B	○	○
CBR SET G	●	●
CBR EXT N	●	●
CBR EXT B	○	○
CBR EXT G	●	●

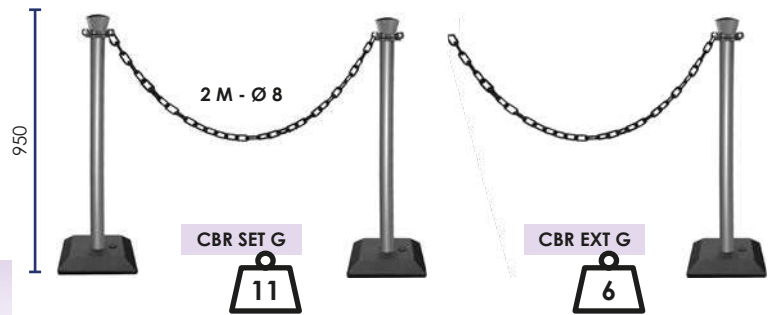

Code		
PPC 1 NN KIT	●	●
PPC 1 BR KIT	○	●
PPC 1 GG KIT	●	●
PPC 1 NN EXT	●	●
PPC 1 BR EXT	○	●
PPC 1 GG EXT	●	●

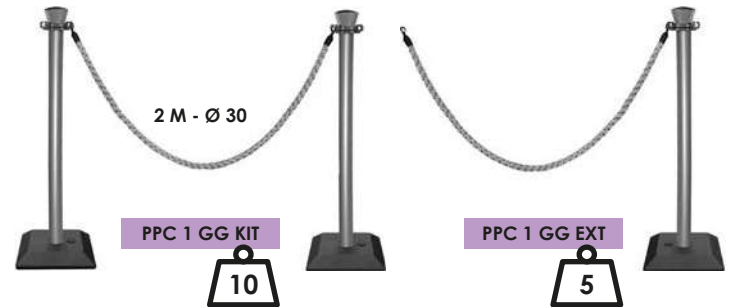

EXISTE AUSSI EN VERSION ◦ ALSO EXISTS IN VERSION  
TAMBIÉN EXISTE EN VERSIÓN ◦ LIEFERBAR IN AUSFÜHRUNGEN

Pliant ▶ p. 173  
Foldable  
Plegable  
Zusammenlegenbar

Base lourde ▶ p. 172  
Heavy base  
Base pesada  
Stanfuss

A planter ▶ p. 172  
With stake  
Con estaca  
Bodenbefestigung



OPTION  
OPTIONAL  
OPCIÓN  
OPTIONAL

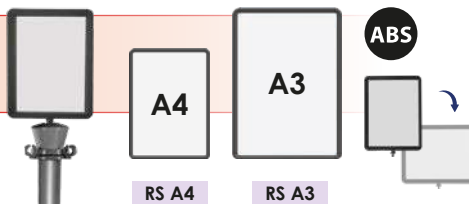

	APF 801 N SB	●
	APF 801 B SB	○
	APO 801 N SB	●
	APO 801 B SB	○





INFORMATION  
SORTIE  
MUSEE DE LYONNE





SWP



## POTEAU D'INFORMATION - HAUTEUR AJUSTABLE

INFORMATION POST - ADJUSTABLE HEIGHT

POSTE DE INFORMACIÓN - ALTURA AJUSTABLE

INFO-PFOSTEN HÖHENVERSTALLBAR



Code		
SWP 4	A4	8
SWP 3	A3	9
SWP 2	A2	10



SWP 2



SWP 3

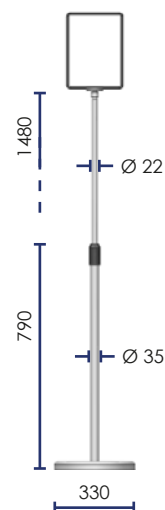

SWP 4

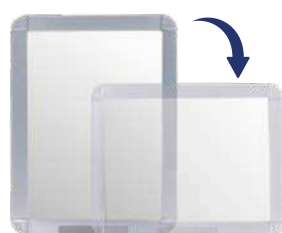

Portrait ou paysage  
Portrait or landscape  
Retrato o paisaje  
Hoch- oder Querformat



SWP 2



SWP 3



SWP 4



SWP ROT

## POTEAUX D'INFORMATION - POSITION ET HAUTEUR RÉGLABLES

INFORMATION POST - ADJUSTABLE POSITION AND HEIGHT

POSTE DE INFORMACIÓN - POSICIÓN Y ALTURA AJUSTABLES

INFO-PFOSTEN - INFOTAFEL VERSTELLBAR (IN 2 RICHTUNGEN)



Code		
SWP 4 ROT	A4	9
SWP 3 ROT*	A3	10,5
SWP 2 ROT	A2	12



Rotule permettant d'orienter ou d'incliner le panneau dans toutes les positions.  
Swivel support allowing the panel to be oriented or tilted in any position.  
Soporte giratorio que permite que el panel sea girado o inclinado en cualquier posición.  
Infotafel ist drehbar und kann in jeder Position fixiert werden

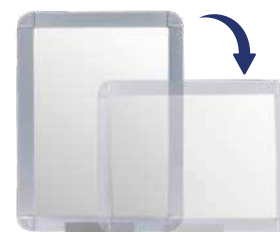
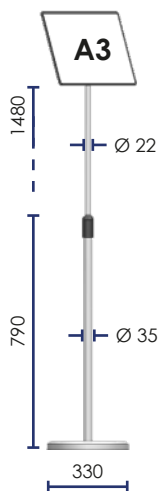

\* Livré avec réglette support menu  
Delivered with a menu support strip  
Entregado con una tira de soporte de menú  
Auflegeleiste inklusive

SWP 4 ROT    SWP 3 ROT    SWP 2 ROT

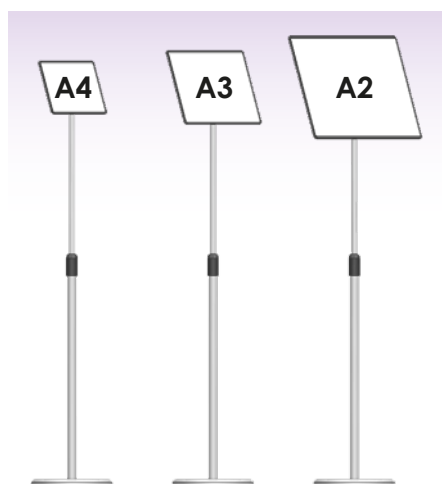



# SWP FIX



## POTEAU D'INFORMATION - HAUTEUR FIXE

### INFORMATION POST ◦ POSTE DE INFORMACIÓN

### INFO PFOSTEN - NICHT HÖHEN VERSTELLBAR



	A4	A3	A2
●	SWP 4 FIX CH	SWP 3 FIX CH	SWP 2 FIX CH
●	SWP 4 FIX BK	SWP 3 FIX BK	SWP 2 FIX BK
●	SWP 4 FIX JA	SWP 3 FIX JA	SWP 2 FIX JA
●	SWP 4 FIX NJ	SWP 3 FIX NJ	SWP 2 FIX NJ
●	SWP 4 FIX RO	SWP 3 FIX RO	SWP 2 FIX RO
●	SWP 4 FIX RB	SWP 3 FIX RB	SWP 2 FIX RB
●	SWP 4 FIX OR	SWP 3 FIX OR	SWP 2 FIX OR
●	SWP 4 FIX VE	SWP 3 FIX VE	SWP 2 FIX VE
●	SWP 4 FIX BU	SWP 3 FIX BU	SWP 2 FIX BU
○	SWP 4 FIX WH	SWP 3 FIX WH	SWP 2 FIX WH
●	SWP 4 FIX GR	SWP 3 FIX GR	SWP 2 FIX GR

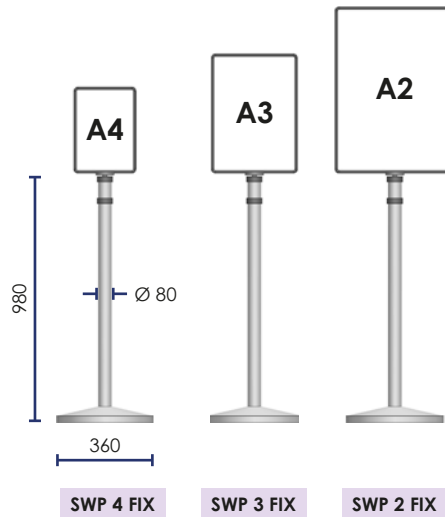

SWP 3 FIX BK

	A4	A3	A2
●	SWPO 4 CH	SWPO 3 CH	SWPO 2 CH
●	SWPO 4 BK	SWPO 3 BK	SWPO 2 BK
●	SWPO 4 JA	SWPO 3 JA	SWPO 2 JA
●	SWPO 4 NJ	SWPO 3 NJ	SWPO 2 NJ
●	SWPO 4 RO	SWPO 3 RO	SWPO 2 RO
●	SWPO 4 RB	SWPO 3 RB	SWPO 2 RB
●	SWPO 4 OR	SWPO 3 OR	SWPO 2 OR
●	SWPO 4 VE	SWPO 3 VE	SWPO 2 VE
●	SWPO 4 BU	SWPO 3 BU	SWPO 2 BU
○	SWPO 4 WH	SWPO 3 WH	SWPO 2 WH
●	SWPO 4 GR	SWPO 3 GR	SWPO 2 GR

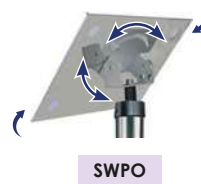

Rotule permettant d'orienter ou d'incliner le panneau dans tous les positions.  
Swivel allowing the panel to be oriented or tilted in any position.  
Giratorio que permite que el panel sea girado o inclinado en cualquier posición.  
Infotafel ist drehbar und kann in jeder Position fixiert werden

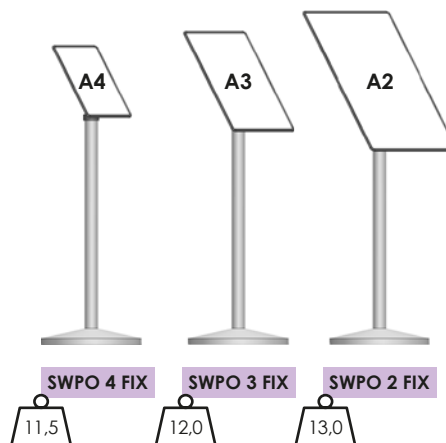

SWPO 3 BK

### SWPO 3

Livré avec réglette support menu  
Delivered with a menu support strip  
Entregado con una tira de soporte de menú  
Aufgabeleiste inklusive



PPC

REXO 4 / 3

## POTEAU D'INFORMATION - HAUTEUR FIXE

INFORMATION POST ◦ POSTE DE INFORMACIÓN

INFO PFOSTEN - NICHT HÖHEN VERSTELLBAR

ACIER ◦ STEEL ◦ ACERO ◦ STAHL



ABS

	A4	A3
●	REXO CH 4	REXO CH 3
●	REXO BK 4	REXO BK 3
●	REXO GO 4	REXO GO 3



7,4

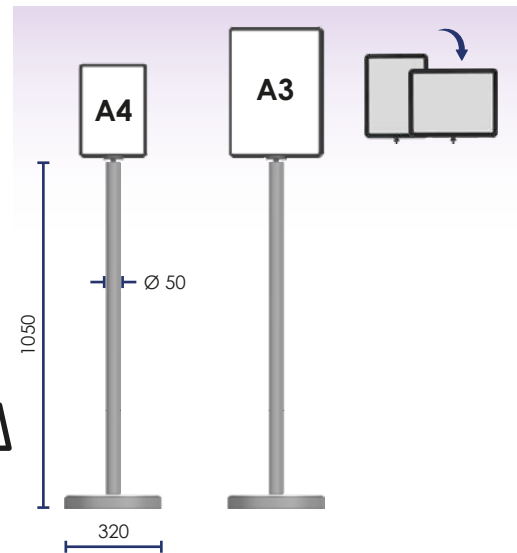

PLASTIQUE ◦ PLASTIC ◦ PLÁSTICO ◦ KUNSTOFF



ABS

	A4
○	PPC A4 B
●	PPC A4 G
●	PPC A4 N

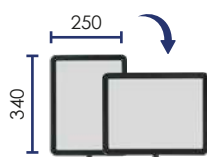

PPC A4 B

PPC A4 G

PPC A4 N

6,0

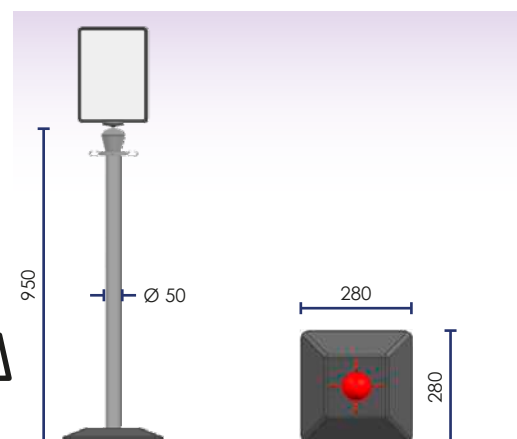



# REXURN

## URNE SUR POTEAU BALLOT BOX ON POST ◦ URNA SOBRE POSTE SAMMELBOX FÜR DEN PFOSTEN



Code		
REXURN 300 CH		500
REXURN 300 LA		
REXURN 300 BK		
REXURN 400 CH		1000
REXURN 400 LA		
REXURN 400 BK		

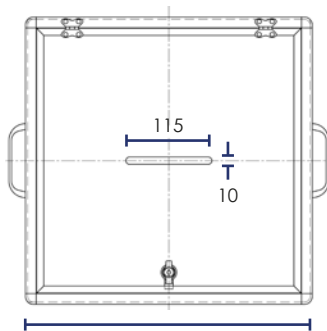

REXURN 400 ▶ 400 x 400  
REXURN 300 ▶ 300 x 300



REXURN 400 ▶ 300  
REXURN 300 ▶ 250  
910  
REXURN 400 ▶ 1210 / REXURN 300 ▶ 1160



7,4

REXURN 300 CH



Crealuxe.fr

REXO V / H

**POTEAU SUPPORT CATALOGUE**  
**BROCHURE HOLDER POST** ◦ **POSTE PORTA FOLLETO**  
**PFOSTEN ABLAGE FÜR KATALOGE / PROSPEKTE**



Code		
REXO CH V		
REXO LA V		
REXO BK V		
REXO CH H		
REXO LA H		
REXO BK H		

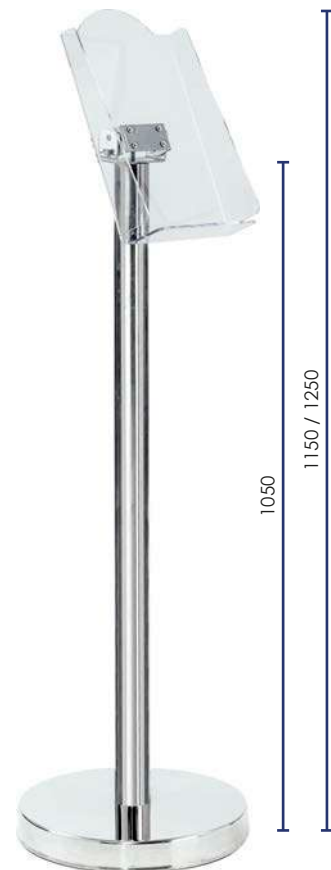
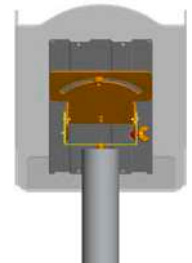
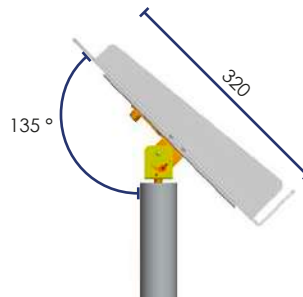
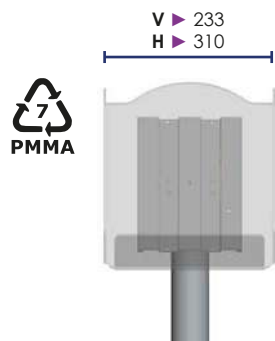



Élections Régionales

Élections Régionales

RUE AMBETTA

3

2



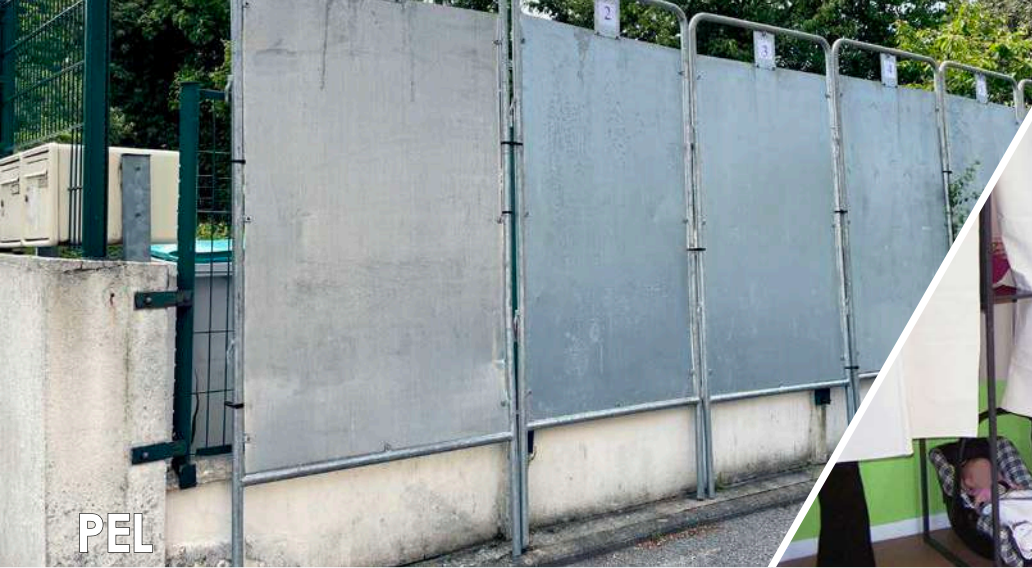

PEL



Crealuxe.fr

ISO

## PANNEAU ELECTORAL

ELECTION POSTER BOARD ◦ CARTELERA ELECTORAL  
PLAKATWAND

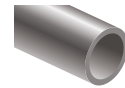

Ø 35 x 1,2



GALVA

Code		
PEL 1023	2300 x 1085	20,0
PEL 1523	2300 x 1585	30,5



OPTION ◦ OPTIONAL  
OPCIÓN ◦ OPTIONAL



PEL FEET2



Avec 2 crochets  
With 2 hooks  
Con 2 ganchos  
Mit 2 Halterungen

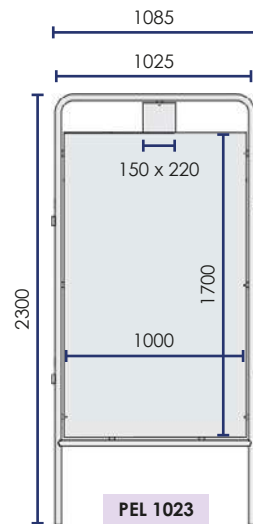

PEL 1023

1 candidat

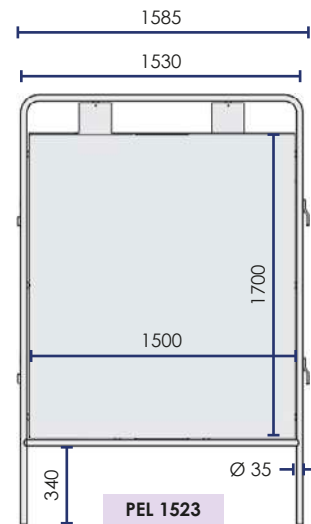

PEL 1523

2 candidats

## ISOLOIR

VOTING BOOTH  
CABINA DE VOTACIÓN ◦ WAHLKABINE

Code		
ISO 800	800 x 800	16
ISO 1300	1000 x 1300	21

Rideaux ignifugés ◦ Fireproof curtains  
Cortinas ignífugas ◦ Feuerfeste Vorhänge



PEINTURE ÉPOXY  
POWDER PAINTING  
PINTURA EPOXICA  
EPOXY FARBE



ISO 1300



ISO 800

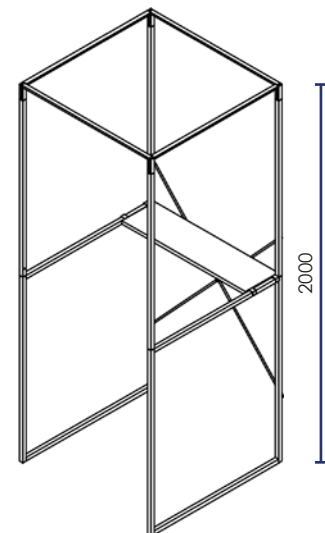

OPTION ◦ OPTIONAL  
OPCIÓN ◦ OPTIONAL



ISO BAG



Liaison  
Link  
Enlace  
Verbindung



# URNOF

## URNE OFFICIELLE AVEC COMPTEUR BALLOT BOX WITH COUNTER ◦ URNA DE VOTO CON CONTADOR WAHLURNE MIT ZÄHLWERK



Code	L	W	H	Poids
URNOF 600	30	1200	350 x 350 x 250	2,3
URNOF 1200	60	2400	400 x 400 x 350	4,4



Compteur intégré  
Counter integrated  
Contador integrado  
Inklusive Zählwerk

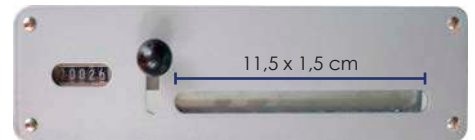

2 poignées  
2 handles  
2 manijas  
2 Tragegriffe



2 charnières  
2 hinges  
2 bisagras  
2 Metallscharniere



Coins renforcés  
Reinforced corners  
Esquinas reforzadas  
Schutzecken



Fermeture par 2 cadenas différents inclus  
Closing by 2 different padlocks included  
Cierre por 2 candados diferentes incluidos  
Schließung durch 2 Vorhangschlösser



URN

**URNE**  
**BALLOT BOX** ◦ **URNA**  
**WAHLURNE**



Code				
<b>URN 300</b>	25	400 / 500	300 x 300 x 250	1,5
<b>URN 400</b>	48	800 / 1000	400 x 400 x 300	2,0

Fente 115 x 10  
 Opening  
 Apertura  
 Einwurfgröße



Fermeture par clés  
 Closing by keys  
 Cierre con llaves  
 Schließung durch Schlüssel



URN 300



URN 400



Coins renforcés  
 Reinforced corners  
 Esquinas reforzadas  
 Schutzecken

Code				
<b>URN 250</b>	15	300 / 400	∅ 200 x 250	1,5
<b>URN 750</b>	50	1000 / 1200	∅ 200 x 750	3,1

Fente 115 x 10  
 Opening  
 Apertura  
 Einwurfgröße



Fermeture par clés  
 Closing by keys  
 Cierre con llaves  
 Schließung durch Schlüssel

Mousse dans le fond  
 Foam at the bottom  
 Espuma en el fondo  
 Schaumstoff für den Boden



URN 250



URN 750



## CASIER POUR EFFETS PERSONNELS

### LOCKER FOR PERSONAL BELONGINGS

### LOCKERS PARA OBJETOS PERSONALES

### AUFBEWAHRUNGSFÄCHER FÜR PERSONAL



Code	
CAS20TEL	525 x 420 x 180



20 clés différentes  
20 different keys  
20 llaves diferentes  
20 unterschiedliche Schlüssel



Charnières acier nickelé  
Nickel plated hinges  
Bisagras de acero niquelado  
Scharniere verchromt

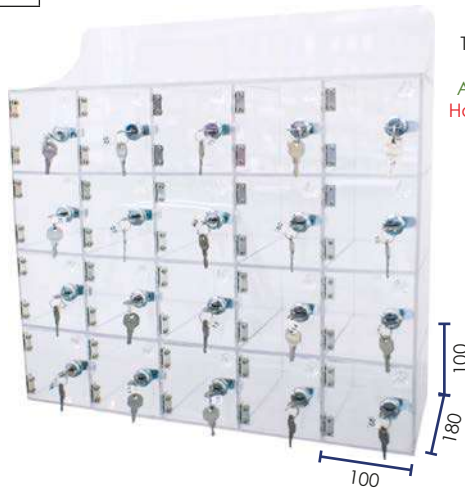

Trous d'accrochage  
Hanging hooks  
Agujeros para colgar  
Haken zum Aufhängen

## COLLECTEUR DE PILES ET CARTOUCHES

### BATTERIES AND CARTRIDGES COLLECTOR

### COLECTOR DE BATERIAS Y CARTUCHOS

### SAMMELBEHÄLTER FÜR BATTERIE & DRUCKERPATRONEN



Code		
BAT 250		7
BAT 750		20
BCC 250		7
BCC 750		20

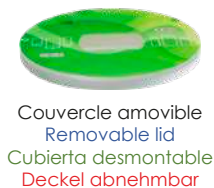
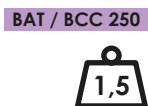

Couvercle amovible  
Removable lid  
Cubierta desmontable  
Deckel abnehmbar

Mousse dans le fond  
Foam at the bottom  
Espuma en el fondo  
Schaumstoff für den Boden



## CADENAS

### PADLOCK

### CANDADO

### VORHANGSCHLOSS

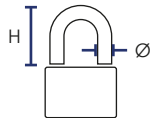

Code	Ø	H	kg
CADSTOP	6	62	0,14
CAD 203 NP (x 3)	2,5	15	0,02
CAD 301 SB / NP	4,4	23	0,04
CAD 401 SB / NP	5	30	0,07
CAD 501 NP	6	35	0,13
CAD 701 G SB	12	60	0,53



CADSTOP



CAD 501 NP



Code	Ø	H	kg
CBAG SB	4	20	0,02
CA 3 COM SB	3	25	0,02
CL 4 COM SB / NP	5	32	0,14



CBAG SB



CA 3 COM SB



CL 4 COM SB





RAMP

ADJ 1100

## RAMPE D'ACCÈS TRANSPORTABLE

TRANSPORTABLE ACCESS RAMP ◦ RAMPA DE ACCESO PORTÁTIL ◦ MOBILE RAMPEN

Code		kg maxi	kg
ADJ 1100	1120 (1010) x 750 x 160	300	9

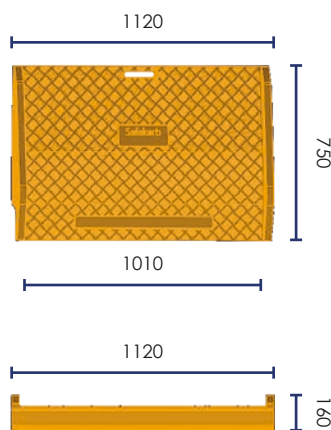

## PLIANTES ◦ FOLDABLE ◦ PLEGABLE ◦ FALTBARE

Code		kg maxi	kg
RAMP 125	1220 x 710 x 50	300	9,2
RAMP 178	1830 x 710 x 50	300	13,8



Bavette ajustable  
Adjustable plate  
Placa ajustable  
Einstellbarer Schaufel

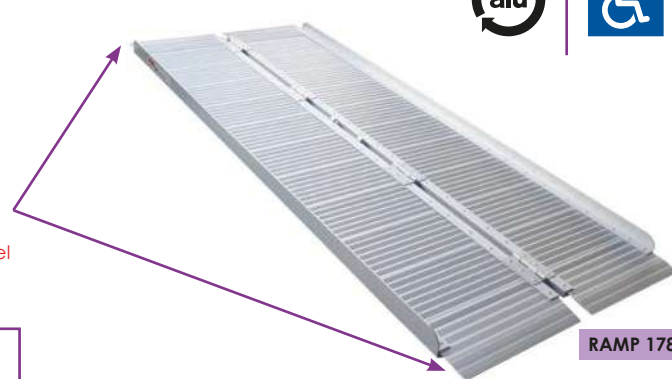

RAMP 178

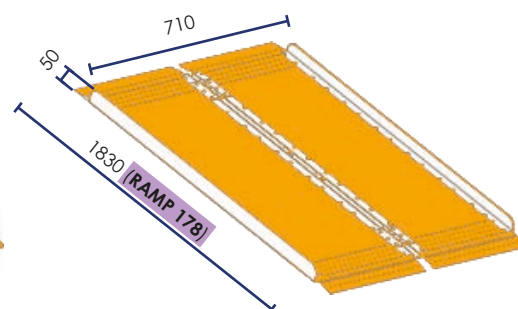
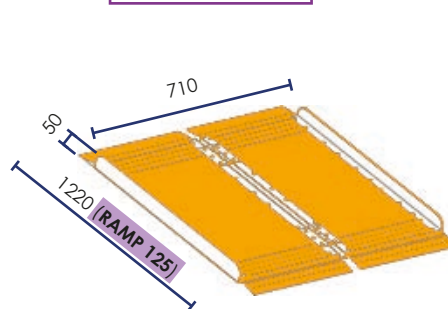







M4161 / 5177

M 450 / 600 / 800

## MIROIR DE SÉCURITÉ

MIRROR ◦ ESPEJO ◦ SICHERHEITSSPIEGEL



Code	 m	
M 450	10	
M 600	15	130°
M 800	25	

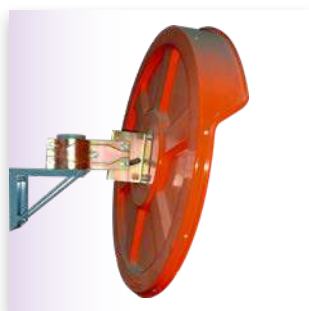

M 450





M 600



M 800



Code	 m	
M 4161	10	
M 5177	20	130°



M 4161



M 5177



INCLUS ◦ INCLUDED ◦ INCLUIDO ◦ INKLUSIVE

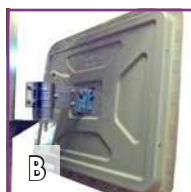
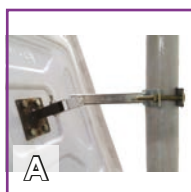

Avec fixation Ø 60 mm selon modèle (A / B)  
With fixation depending on model (A / B)  
Con fijaciones según referencia (A / B)  
Mit Befestigung nach Modell (A / B)





MIROIR

MS 360

**MIROIR INTÉRIEUR DE SÉCURITÉ**  
**INDOOR USE SAFETY MIRROR** ○ **ESPEJO INTERIOR DE SEGURIDAD**  
**INNEN BEOBACHTUNGSSPIEGEL**



Code	m	
MS 90	10	90°
MS 180	15	180°
MS 360	25	360°



Ø 650 (1/4)

MS 90



Ø 650 (1/2)

MS 180



Ø 650

MS 360



**MIROIR DE SÉCURITÉ**  
**MIRROR** ○ **ESPEJO** ○ **SICHERHEITSSPIEGEL**



Code	m	
MIROIR	5	130°

Tige flexible 30 cm  
 Flexible stem  
 Varilla flexible  
 Flexibler Stab



Ø 330

MIROIR

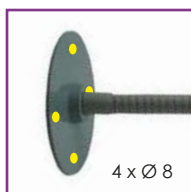





**PSG 680**

## BALISE CHEVALET INOX

STAINLESS STEEL FLOOR SIGN ◦ BALIZA DE SUELO EN ACERO INOXIDABLE  
WARNAUFSTELLER AUS INOX



Verrouillage ouverture  
Opening lock  
Bloqueo apertura  
Verriegelung der Öffnung

A personnaliser avec des stickers ou sur demande  
To customize with stickers or on request  
Personalización con adhesivos o bajo pedido  
Individuelle Sticker  
Ausführung auf Anfrage

## CHEVALET SOL

FLOOR SIGN ◦ BALIZA DE SUELO  
WARNAUFSTELLER



  
+ livré avec 2 x 2 stickers  
+ delivered with 2 x 2 stickers  
+ suministrado con 2 x 2 pegatinas  
lieferbar mit 2 x 2 Warnsticker

NETTOYAGE  
EN COURS  
WORK  
IN PROGRESS  
ACHTUNG!  
REINIGUNG  
LIMPIEZA  
EN CURSO



ATTENTION  
CAUTION  
CUIDADO  
ACHTUNG  
ATTENZIONE



A personnaliser avec des stickers ou sur demande  
To customize with stickers or on request  
Personalización con adhesivos o bajo pedido  
Individuelle Sticker  
Ausführung auf Anfrage



PSG 700

**CHEVALET SOL PREMIUM**  
 PREMIUM FLOOR SIGN ◦ BALISA DE SUELO PREMIUM  
 WARNAUFSTELLER IN PREMIUM QUALITÄT



PSG 700 BU



PSG 700 RO



PSG 700



A personnaliser avec des stickers ou sur demande  
 To customize with stickers  
 or on request  
 Personalizable con pegatinas o a petición  
 Individuelle Sticker Ausführung auf Anfrage

Poignée ergonomique  
 Ergonomic handle  
 Mango ergonómico  
 Ergonomischer Griff



PSGI 700



PSGG 700



PSGP 700



PSGE 700



PSGATT 700



PSGD 700



PSGT 700



PSGSI 700



PSGNOPASS 700



PSGTVX 700



CSL



Crealluxe.fr

PSG 501

**CÔNE PARAPLUIE SOL GLISSANT**  
**POP UP WET FLOOR SIGN** ◦ **CONO PLEGABLE SUELO MOJADO**  
**WARNAUFSTELLER MIT HINWEIS «RUTSCHGEFAHR»**

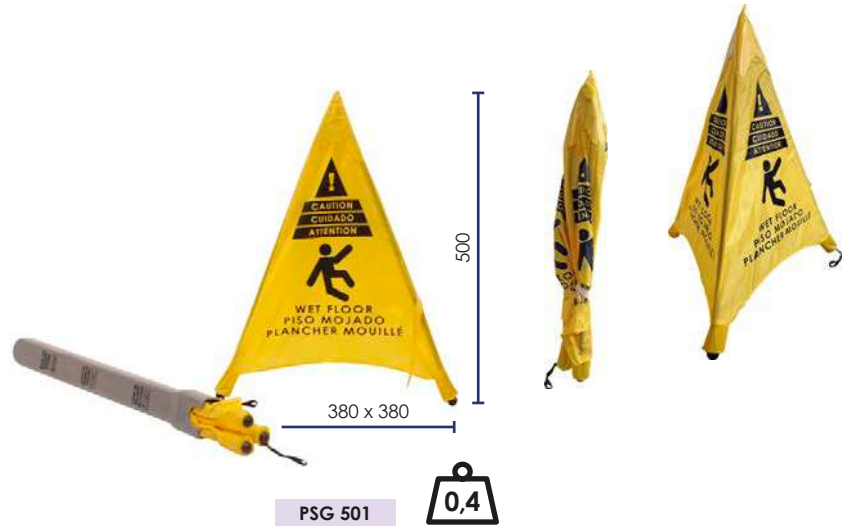

**BALISE DE RUE**  
**BLACK CUSTOMIZABLE CONE** ◦ **BALIZA** ◦ **STRASSEN LEITBAKE**



Classe 1  
 Class 1  
 Clase 1  
 Klasse 1

Réfléchissant  
 Reflective  
 Reflectante  
 Reflektierende

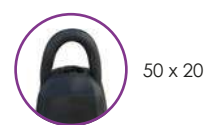

Personnalisation : mini 100  
 Customization mini 100  
 Personalización mini 100  
 Personalisierung : Mini 100

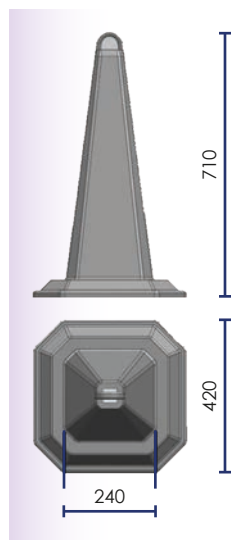





RSNT 100



RSA

**RUBAN DE BALISAGE** ◦ MARKING TAPE ◦ CINTA DE SEÑALIZACIÓN ◦ BODENMARKIERUNG

**ADHÉSIF** ◦ ADHESIVE ◦ ADHESIVO ◦ Klebstoff

Code		
RSA 335 STOP NJ		x 6
RSA 335 NJ		x 6
RSA 335 RB		x 6



RSA 335 STOP NJ



RSA 335 NJ



RSA 335 RB



**ANTI-DÉRAPANT** ◦ NON SKID ◦ ANTIDESLIZANTE ◦ ANTIRUTSCH VERSION

Code		
RSA 550 BK		x 6
RSA 550 NJ		x 6
RSA 550 RB		x 6
RSA 550 BYB		x 6

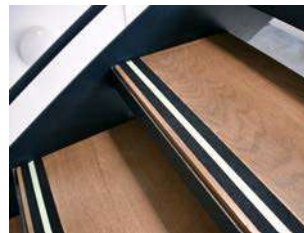
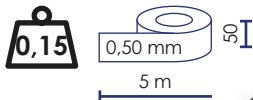

RSA 550 BYB



Code		
RSA 5100 BK		x 1
RSA 5100 NJ		x 1

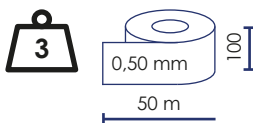

RSA 5100 BK

**RÉFLÉCHISSANT ET ANTI-DÉRAPANT \*** ◦ NON SKID AND REFLECTIVE  
REFLECTIVO Y ANTIDESLIZANTE ◦ REFLEKTIEREND & ANTIRUTSCH VERSION

Code		
RSNT 100 JA		x 1
RSNT 100 BL		x 1
PODGLUE2 *		



\* A poser avec colle ◦ To fix with glue ◦ Usar pegamento ◦ Befestigung durch Kleber



Colle époxydique souple 2 composants pour béton  
Flexible 2-component epoxy adhesive for concrete  
Adhesivo epoxidico flexible de 2 componentes para hormigón  
2-Komponenten Kleber für Beton





PDM



NDM

## NEZ DE MARCHE ANTIDÉRAPANT ○ NON-SLIP STAIR NOSING PERFIL ANTIDESLIZANTE PARA PELDAÑOS ○ RUSTCHFEST TREPPENKANTENPROFIL



Code			
NDM 900 PVC			0,80
NDM 900 BK			0,80
NDM 900 FLUO			0,80
NDM 1300 PVC			1,20
NDM 1300 BK			1,20
NDM 1300 FLUO			1,20

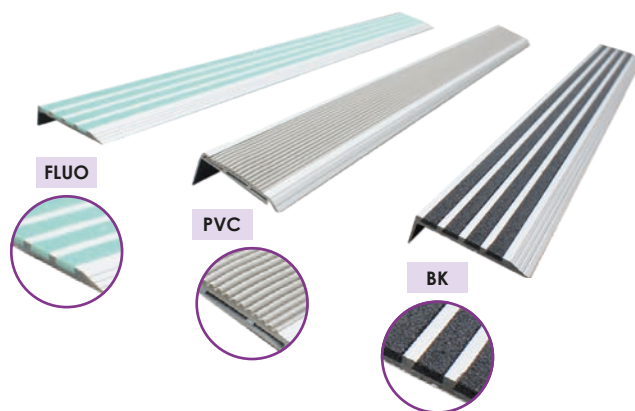

non fourni ○ not supplied ○ no incluido ○ nicht enthalten

NDM 900



900



NDM 1300



1300

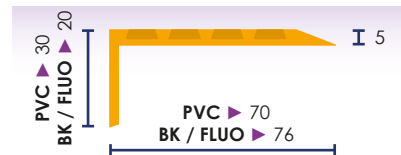

## PLAT DE MARCHE ○ STAIRS PAD PERFIL ANTIDESLIZANTE PARA PELDAÑOS ○ TREPPENKANTEN



Code			
PDM 900 PVC			0,80
PDM 900 BK			0,80
PDM 1300 PVC			1,10
PDM 1300 BK			1,10

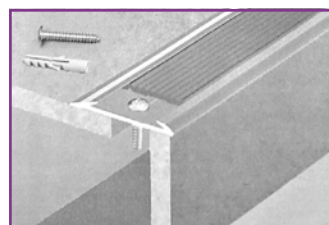

non fourni ○ not supplied ○ no incluido ○ nicht enthalten

PDM 900



900



PDM 1300



1300

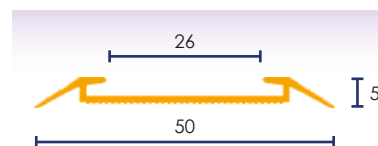

OPTION  
OPCIÓN  
OPCIÓN



RQ GLUE





## CHIFFRE AUTOCOLLANT

SELF-ADHESIVE NUMBER ◦ NÚMERO DE SEÑALIZACIÓN ADHESIVO  
ZAHLEN SELBSTKLEBEND

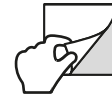

56 X 80

x 10



0

CA 0

1

CA 1

2

CA 2

3

CA 3

4

CA 4

5

CA 5

6

CA 6

7

CA 7

8

CA 8

9

CA 9

## CHIFFRES ET LETTRES ADHÉSIFS

ADHESIVE LETTERS AND NUMBERS ◦ LETRAS Y NÚMEROS ADHESIVOS  
ZAHLEN UND BUCHSTABEN SELBSTKLEBEND

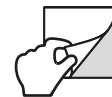

A

60

LA60N



	A	B	C	D	E	F	G	H	I	J	K	L	M	N	O
	3	3	2	2	5	1	2	2	12	2	2	6	2	5	2

	P	Q	R	S	T	U	V	W	X	Y	Z	€	Ø	.
	2	1	3	4	4	4	2	1	1	1	1	1	1	33

3

60

CA60N



	0	1	2	3	4	5	6	7	8	9	€	-	+	.	,
	5	14	3	3	3	5	3	3	3	3	2	1	1	22	2



## CHIFFRES DE RUE

STREET NUMBERS ◦ NÚMERO DE SEÑALIZACIÓN ◦ HAUSNUMMER

ADHÉSIF FINITION DORÉE ◦ GOLDEN FINISH SELF ADHESIVE  
ADHESIVO ACABADO DORADO ◦ SELBSTKLEBEND - GOLDFARBIG

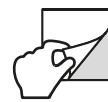

H 40 MM

x 5



0 1 2 3 4 5 6 7 8 9

CALT 0

CALT 1

CALT 2

CALT 3

CALT 4

CALT 5

CALT 6

CALT 7

CALT 8

CALT 9

## À CLOUER ◦ TO NAIL

A CLAVAR ◦ ZUM NAGELN



ZAMAK

H 80 MM

x 5

INCLUS ◦ INCLUDED  
INCLUIDO ◦ INKLUSIVE



0 1 2 3 4 5

CRZ 0

CRZ 1

CRZ 2

CRZ 3

CRZ 4

CRZ 5

6 7 8 9 BIS TER

CRZ 6

CRZ 7

CRZ 8

CRZ 9

CRZ BIS

CRZ TER

0 1 2 3 4 5

CZL 0

CZL 1

CZL 2

CZL 3

CZL 4

CZL 5

6 7 8 9 BIS TER

CZL 6

CZL 7

CZL 8

CZL 9

CZL BIS

CZL TER



# SÉRIE S

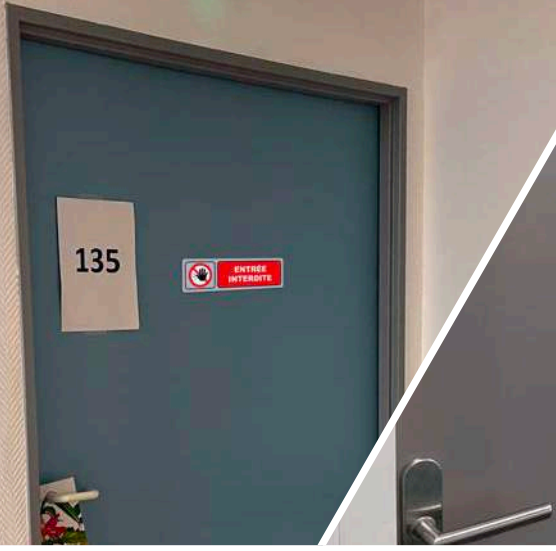

Crealuxe.fr



# PALU

## PANNEAU ALUMINIUM ADHÉSIF

ADHESIVE ALUMINUM SIGN ◦ PANEL ADHESIVO ALUMINIO  
HINWEISSCHILDER AUS ALUMINIUM - SELBSTKLEBEND

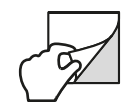

Ø 80 MM x 5

- |            |             |             |             |             |             |             |            |
|------------|-------------|-------------|-------------|-------------|-------------|-------------|------------|
| <br>PALU 1 | <br>PALU 2  | <br>PALU 3  | <br>PALU 4  | <br>PALU 5  | <br>PALU 6  | <br>PALU 7  | <br>PALU 8 |
| <br>PALU 9 | <br>PALU 10 | <br>PALU 11 | <br>PALU 12 | <br>PALU 13 | <br>PALU 14 | <br>PALU 15 |            |

## PANNEAU ADHÉSIF

ADHESIVE SIGN ◦ PANEL ADHESIVO  
HINWEISSCHILDER - SELBSTKLEBEND

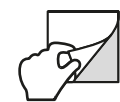

170 X 50 x 5



- |          |          |          |          |
|----------|----------|----------|----------|
| <br>S 2A | <br>S 11 | <br>S 14 | <br>S 24 |
| <br>S 28 | <br>S 29 | <br>S 31 | <br>S 32 |
| <br>S 33 | <br>S 34 | <br>S 35 | <br>S 36 |
| <br>S 37 | <br>S 38 | <br>S 39 | <br>S 40 |
| <br>S 41 |          |          |          |



**PANNEAU ADHÉSIF**  
 ADHESIVE SIGN ◦ PANEL ADHESIVO  
 HINWEISSCHILDER - SELBSTKLEBEND



Ø 180 MM x 5



DPP 1



DPP 2



DPP 2ST



DPP 3



DPP 4

Ø 280 MM x 5



DPE 2



DPE 3



DPE 6BD



DP 8



DP 10



DP 11



DP 12



DP 13



DP 14



DP 15



DP 16



DP 17



DP 18



DP 19



DP 20



DP 21



DP 22



DP 23



DP 24



DP 25



**PANNEAU ADHÉSIF**  
 ADHESIVE SIGN ◦ PANEL ADHESIVO  
 HINWEISSCHILDER - SELBSTKLEBEND

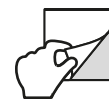

Ø 280 MM | x 5



DPO 30



DPO 31



DPO 32



DPO 33



DPO 34



DPO 35



DPO 36



DPO 37



DPO 38



DPO 39



DPO 40

320 X 120 | x 5



LPR 33



LPR 34



LPR 35



LPR 36



LPR 37



LPC 38

(200 X 200)

280 X 190 | x 5



LP 2



LP 12



LP 15



LP 16



LP 17



LP 30



LP 31



LP 32

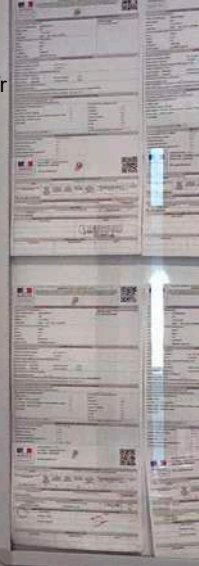
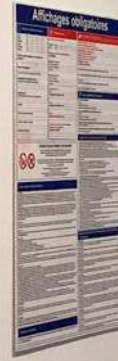

**PANNEAU AFFICHAGE LÉGAL**  
**FRENCH LEGAL MENTION SIGN**  
**PANEL OBLIGACIONES LEGALES (FRANCIA)**  
**SICHERHEITS- UND HINWEISTAFEL**

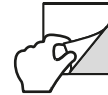

300 X 400 x 5



PAO 300



PNAE 300



PNUR 300 S



A series of horizontal lines for writing, starting from the top of the page and extending downwards.

*Créa Luxe . fr*

Crealuxe SARL  
BP 4003584101 Orange CEDEX  
04 86 71 54 42  
serviceclient@crealuxe.fr

