



Chantier ◦ Construction



SERVIER

35

35

LVS VISO

PROTÈGE CÂBLES ◦ CABLE COVERS

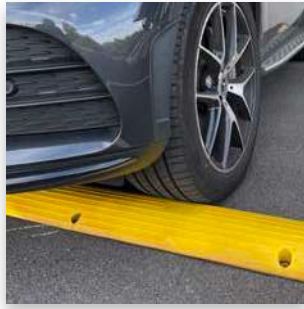

CÔNES ◦ CONES



RAMPE ◦ RAMPS



BALISAGE ◦ SAFETY MARKING

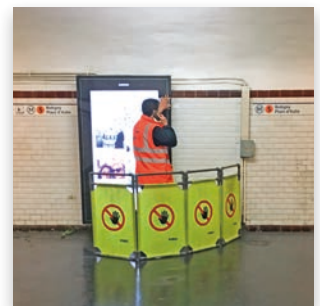



PASSE-CÂBLES ◦ CABLES COVERS ◦ PROTECTOR DE CABLES ◦ KABELBRÜCKEN

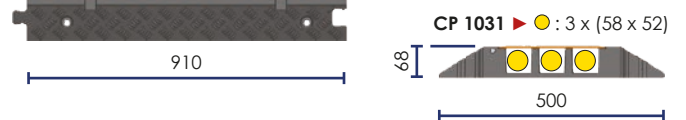
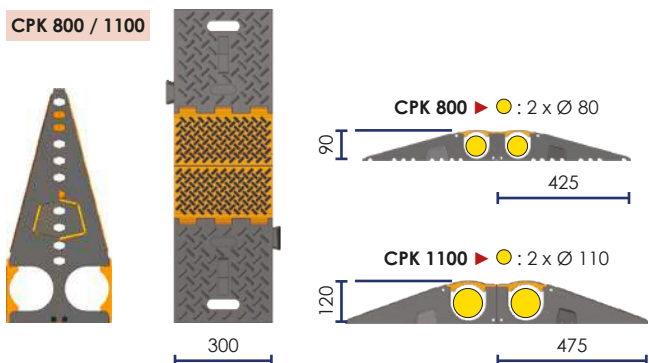
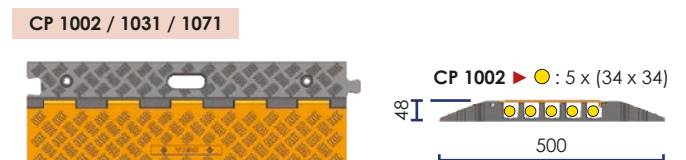
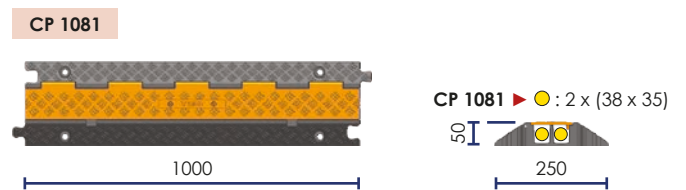
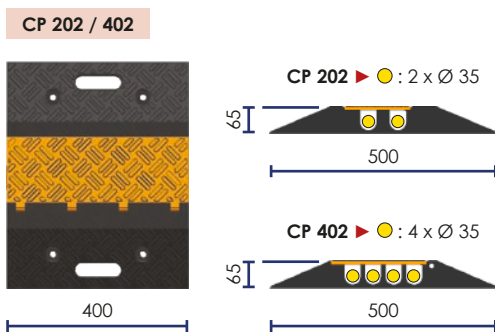
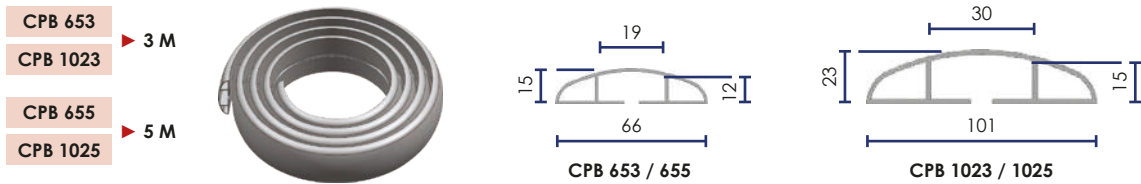



PASSE-CÂBLES ◦ CABLES COVERS ◦ PROTECTOR DE CABLES ◦ KABELBRÜCKEN

CP 500 / 800 / 1200

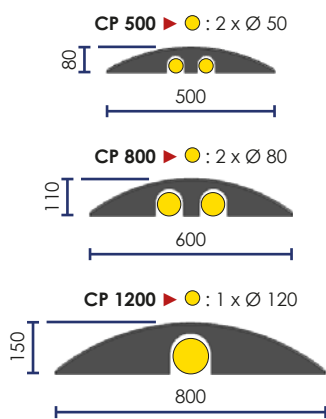

CPO 600 / 850 / 1000

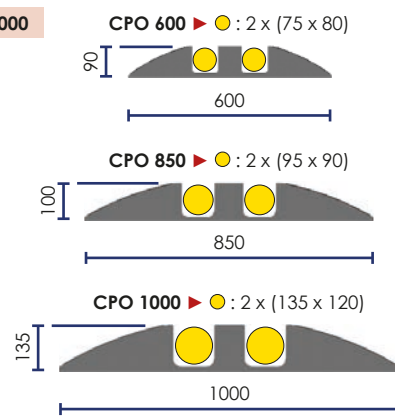

WP 100 ▶ 10 M
WP 170 ▶ 4 M

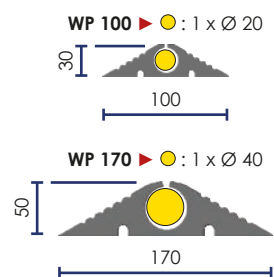

WP 240

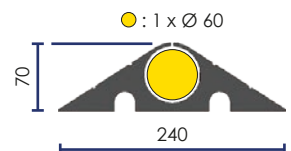
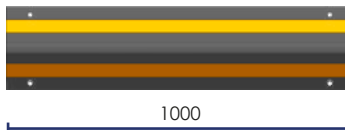

CP 450

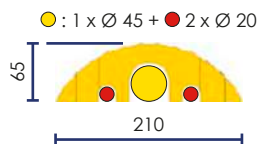
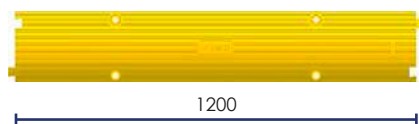

SAFETY 100

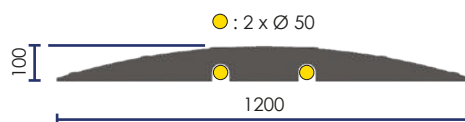

ZEBRA 65 / 100

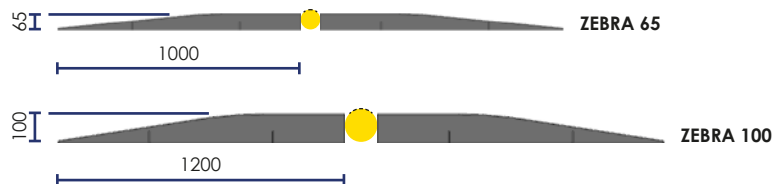
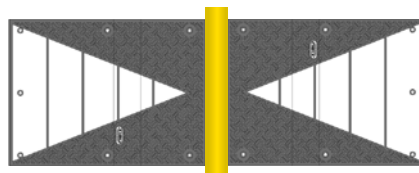



CPB

PASSE CÂBLE DE BUREAU ◦ FLOOR CABLE COVER
PROTECTOR DE CABLES ◦ FUSSBODEN KABELBRÜCKE ◦ BODEN KABELBRÜCKE



SOUPLE ◦ FLEXIBLE ◦ FLEXIBLE ◦ WEICH

Code	↔	kg
CPB 653	3 m	1,40
CPB 655	5 m	2,20
CPB 1023	3 m	3,00
CPB 1025	5 m	4,90

- CPB 653 / 655 ▶ 19 x 12
- CPB 1023 / 1025 ▶ 30 x 15

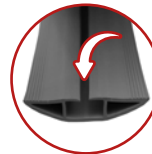

- En rouleau
- Chargement par le dessous
- Découpe facile au cutter
- Livré avec adhésif double face

- In roll
- Bottom loading
- Easy to cut with a cutter
- Supplied with double-sided tape

- En rollo
- Cargando desde abajo
- Fácil de cortar con un cúter
- Se suministra con adhesivo de doble cara

- In Rollen
- Ladung vom Unten
- Einfaches Schneiden mit dem Cutter
- Geliefert mit doppelseitigem Klebstoff

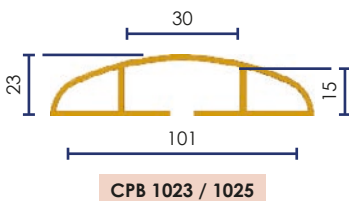
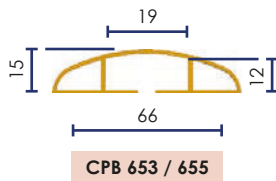

INCLUS
INCLUDED
INCLUIDO
INKLUSIVE



RIGIDE ◦ RIGID ◦ RÍGIDO ◦ STARR

Code	↔	kg
CPB 702	2 m	1,00
CPB 70 T		0,05
CPB 70 L		0,05

- ▶ 2 x (17 x 10)

CPB 702



- Découpe possible à la longueur souhaitée
- Avec adhésif double face

- Can be cut to the desired length
- Supplied with double-sided tape

- Puede ser cortado a la longitud deseada
- Se suministra con adhesivo de doble cara

CPB 70 T



- Kann auf die Gewünschte Länge geschnitten werden
- Geliefert mit doppelseitigem Klebstoff

CPB 70 L



INCLUS
INCLUDED
INCLUIDO
INKLUSIVE

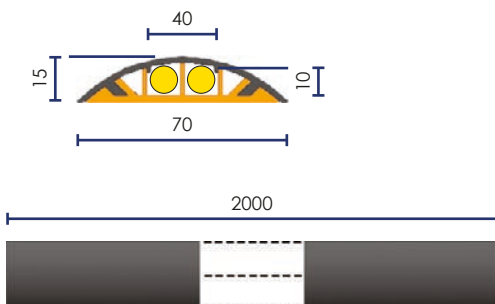
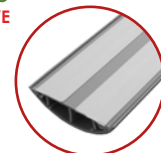



CP 5040

PASSE CÂBLE PIÉTON ○ **PEDESTRIAN CABLE COVER**

PROTECTOR DE CABLES PEATONES ○ **KABELBRÜCKE FÜR FUSSGÄNGERVERKEHR**

● 2 x Ø 20 + 5 x Ø 25

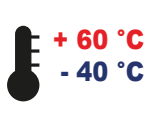

INSTALLATION TEMPORAIRE ○ **TEMPORARY USE** ○ **USO TEMPORARIO** ○ **VORÜBERGEHENDE NUTZUNG**

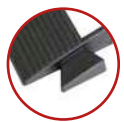
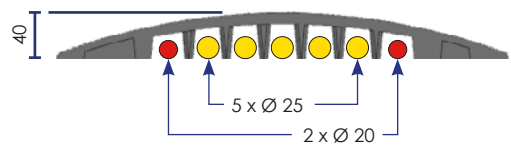
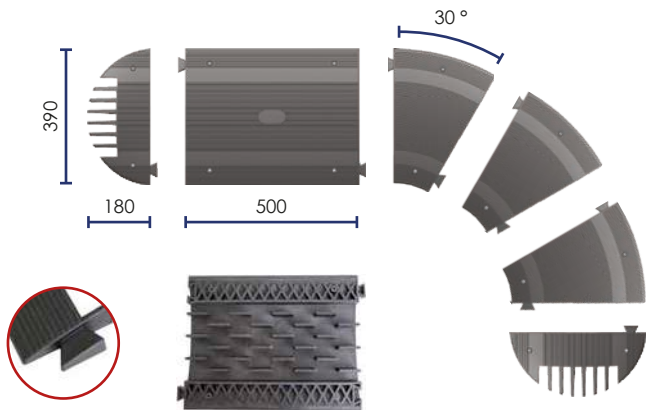

CP 5040



CPR 5040



CPE 5040

- Utilisation lors d'évènements en intérieur ou en extérieur dans les zones piétonnes (expositions, foires, etc.)
- Equipé d'emplacements pour mettre 2 bandes réfléchissantes classe 1 pour plus de sécurité
- To use at events both indoor and outdoor in pedestrian areas (exhibitions, fairs etc.)
- Equipped with space to put 2 class 1 reflective strips for more safety
- Para su uso en eventos tanto en el interior como en el exterior en zonas peatonales (exposiciones, ferias, etc.)
- Equipado con ranuras para poner 2 tiras reflectantes de clase 1 para mayor seguridad
- Einsatz bei Events im Innen- und Außenbereich in Fußgängerzonen (Ausstellungen, Messen, usw.)
- Ausgestattet mit Platzierung für 2 Reflektoren Streifen Klasse 1 für mehr Sicherheit

INCLUS
INCLUDED ○ INCLUIDO ○ INKLUSIVE



A collar ○ To stick
A pegar ○ Zu kleben

OPTION
OPTIONAL ○ OPCIÓN ○ OPTIONAL



CP 5 FIX SB
Ø 8 x 60





CP 5 SPIKE SB
Ø 6 x 300







CP 202 / 402

PASSE CÂBLE MODULAIRE ◦ **MODULAR CABLE PROTECTOR**
PROTECTOR DE CABLES MODULAR ◦ **KABELBRÜCKE MODULAR**

-  CP 202 ▶ 2 x Ø 35
-  CP 402 ▶ 4 x Ø 35



INSTALLATION TEMPORAIRE ◦ **TEMPORARY USE** ◦ **USO TEMPORARIO** ◦ **VORÜBERGEHENDE NUTZUNG**

Code		
CP 202	4	9,0
CPR 202	3	9,5
CPE 202	2	4,0
CP 402	4	8,0
CPR 402	3	8,0
CPE 402	2	3,0

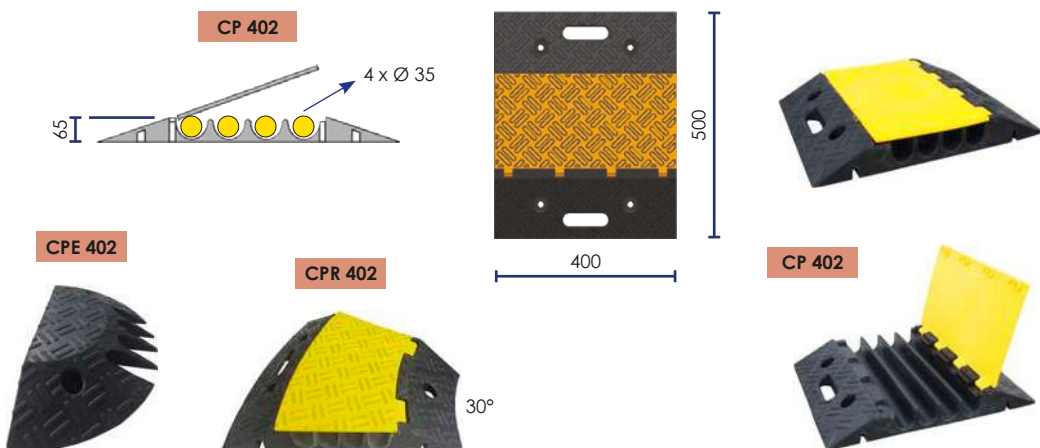
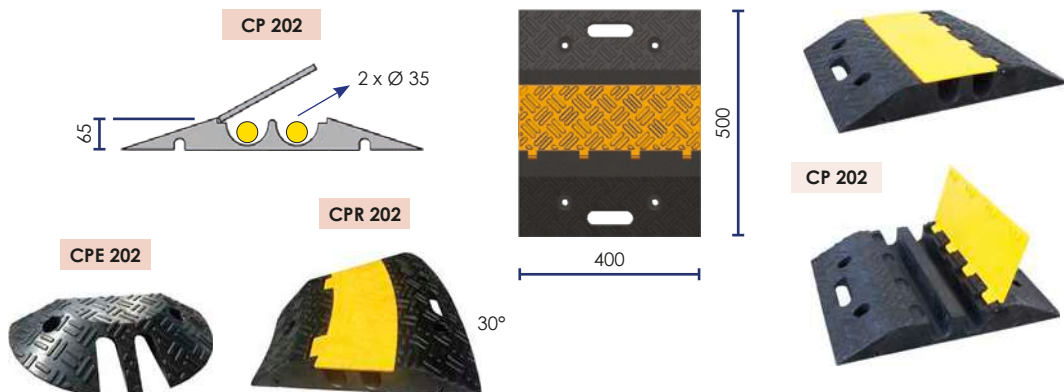

OPTION ◦ **OPTIONAL** ◦ **OPCIÓN** ◦ **OPTIONAL**



H de liaison pour connecter les éléments entre eux
 H links for connecting the elements together
 H de unión para conectar los elementos
 H Verbindung zum Verbinden von Bauteilen



SPIKES
 Ø 12 x 300



FIX 4 SB
 Ø 12 x 130



RQ GLUE



CPK 800 / 1100

PASSE CÂBLE TRANSPORTABLE PLIANT

FOLDABLE CABLE PROTECTOR

PROTECTOR DE CABLES PLEGABLE ◦ KABELBRÜCKE TRAGBAR/FALTBAR

● CPK 800 ▶ 2 x Ø 80

● CPK 1100 ▶ 2 x Ø 110



CAOUTCHOUC VULCANISÉ
VULCANIZED RUBBER
CAUCHO VULCANIZADO
VULKANISIERTEM KAUSCHUK



Couvercle
Lid
Tapa
Deckel



INSTALLATION TEMPORAIRE ◦ TEMPORARY USE ◦ USO TEMPORARIO ◦ VORÜBERGEHENDE NUTZUNG

Code			
CPK 800	300 x 190 x 425	850 x 300 x 90	18,40
CPK 1100	300 x 240 x 475	950 x 300 x 120	25,00

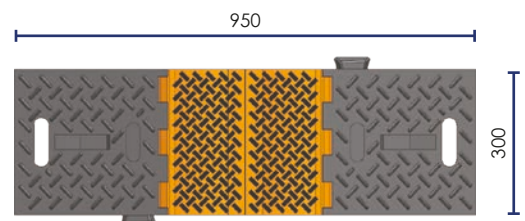
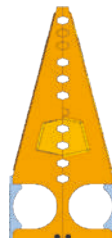
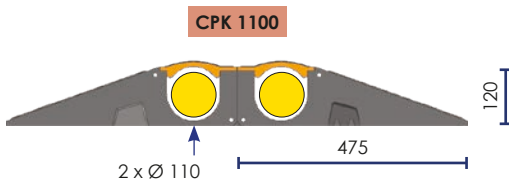
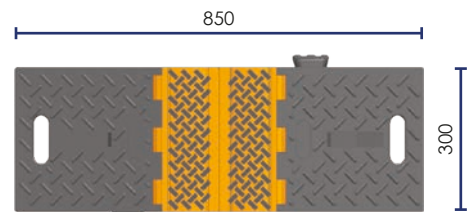
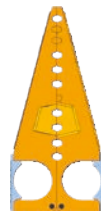
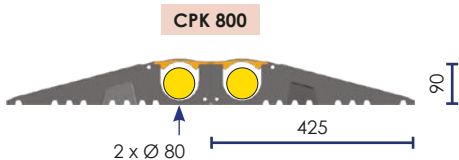

OPTION
OPTIONAL ◦ OPCIÓN ◦ OPTIONAL

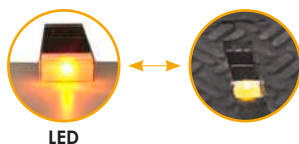

LED





CP 1000 SÉRIE

PASSE CÂBLE ◦ CABLE BRIDGE ◦ PROTECTOR DE CABLES ◦ KABELBRÜCKE



CAOUTCHOUC
RUBBER
CAUCHO
KAUSCHUK



Couvercle
Lid
Tapa
Deckel



INSTALLATION TEMPORAIRE
TEMPORARY USE
USO TEMPORARIO
VORÜBERGEHENDE NUTZUNG

CP 1081

2 x (38 x 35)

Code	kg
CP 1081	9,0
CPR 1081	2,0
CPE 1081	1,0
CPS 1081	2,7

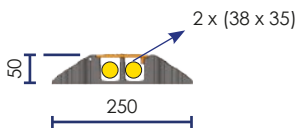
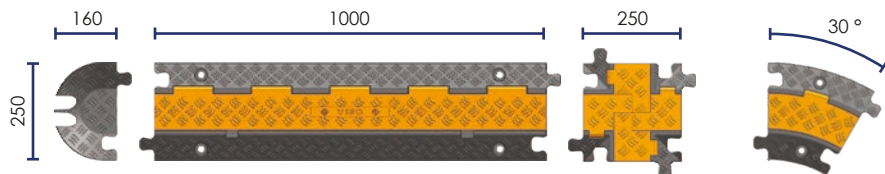

CP 1002

5 x (34 x 34)

Code	kg
CP 1002	17,2
CPR 1002	5,0
CPE 1002	3,0
CPS 1002	10

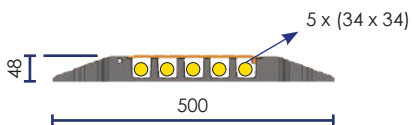
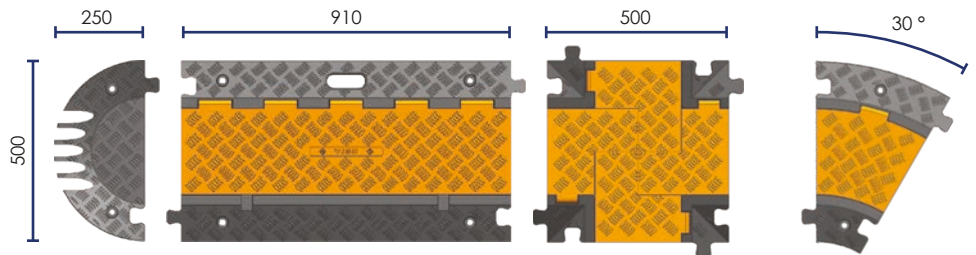

Poignée
Handle
Asa
Handgriff

Trous de fixation
Fixation holes
Agujeros de fijación
Befestigungslöcher

Assemblage
Assembling
Montaje
Montage

Fermeture capot
Lid closing
Cierre tapa
Deckel Verschlussung

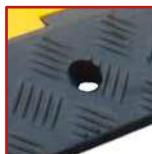

- ▶ CP 1002
- ▶ CP 1031
- ▶ CP 1071

OPTION ◦ OPTIONAL ◦ OPCIÓN ◦ OPTIONAL



SPIKE 4 SB
Ø 12 x 300



FIX 1 SB
Ø 12 x 130



RQ GLUE



PASSE CÂBLE ◦ **CABLE BRIDGE** ◦ **PROTECTOR DE CABLES** ◦ **KABELBRÜCKE**



CAOUTCHOUC
RUBBER
CAUCHO
KAUSCHUK



Couvercle
Lid
Tapa
Deckel



INSTALLATION TEMPORAIRE
TEMPORARY USE
USO TEMPORARIO
VORÜBERGEHENDE NUTZUNG

CP 1031 3 x (58 x 52)

Code	kg
CP 1031	16,8
CPR 1031	4,6
CPE 1031	3,5
CPS 1031	13,0

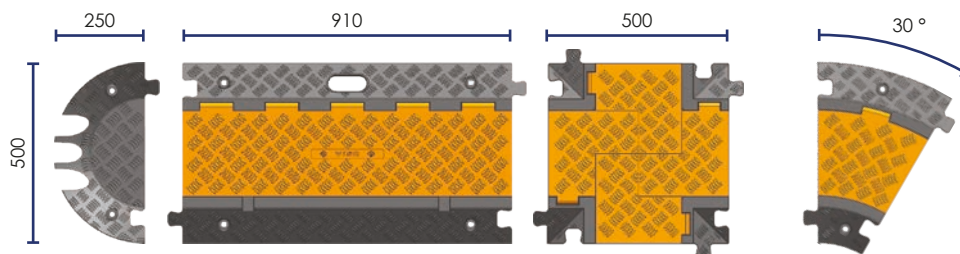
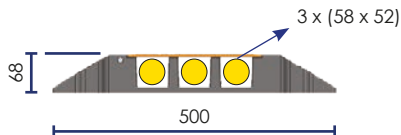

CP 1071 3 x (65 x 65)

Code	kg
CP 1071	23,0
CPR 1071	6,8
CPE 1071	4,5
CPS 1071	12,0

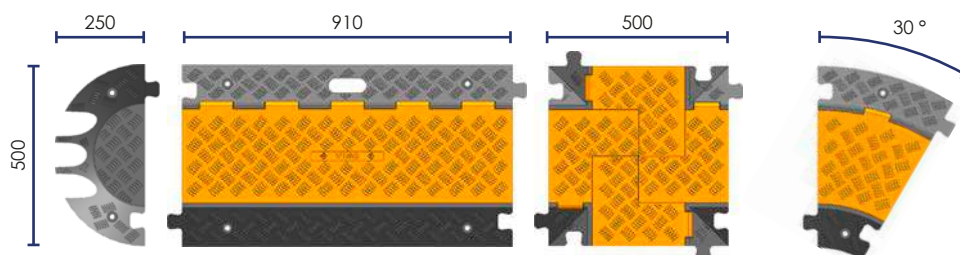
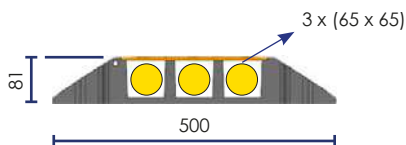

OPTION ◦ **OPTIONAL** ◦ **OPCIÓN** ◦ **OPTIONAL**

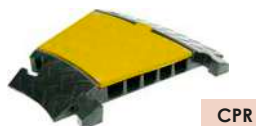



CPO

PASSE CÂBLE ET TUYAUX POIDS LOURD

HOSE AND CABLE BRIDGE

PROTECTOR DE CABLE Y MANGUERA

KABELBRÜCKE UND SCHLÄUCHE FÜR LKW

- CPO 600 ▶ 2 x (75 x 80)
- CPO 850 ▶ 2 x (95 x 90)
- CPO 1000 ▶ 2 x (135 x 120)

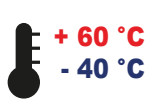

CAOUTCHOUC VULCANISÉ
VULCANIZED RUBBER
CAUCHO VULCANIZADO
VULKANISIERTEM KAUSCHUK

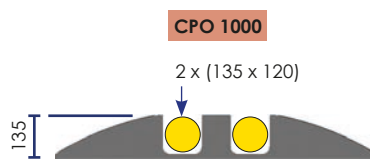
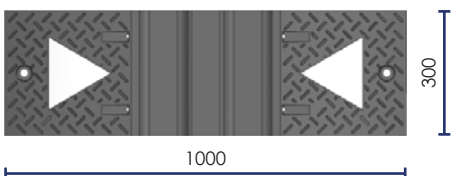
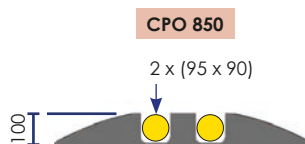
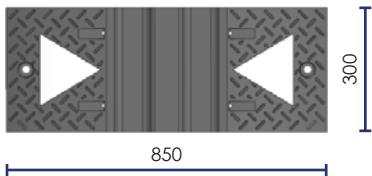
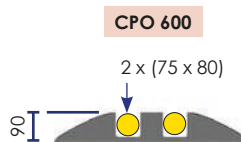
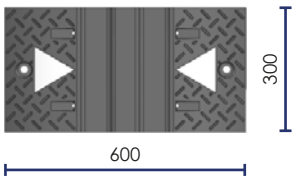

INCLUS ◦ INCLUDED ◦ INCLUIDO ◦ INKLUSIVE



x 4

OPTION ◦ OPTIONAL ◦ OPCIÓN ◦ OPTIONAL



GEY 1 SB

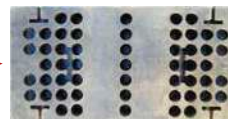

SPIKES
Ø 12 x 300



FIX 1 SB
Ø 12 x 130



RQ GLUE



Crealuxe.fr





CP

PASSE CÂBLE ET TUYAUX POIDS LOURD

HOSE AND CABLE BRIDGE

PROTECTOR DE CABLE Y MANGUERA

LKW KABELBRÜCKE FÜR KABEL UND SCHLÄUCHE

-  CP 500 ▶ 2 x Ø 50
-  CP 800 ▶ 2 x Ø 80
-  CP 1200 ▶ 1 x Ø 120

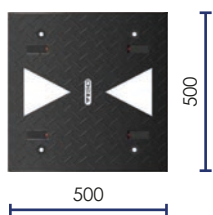

CP 500

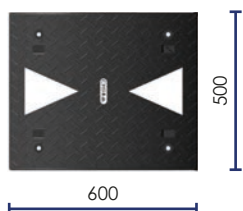
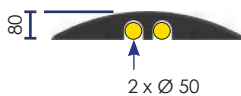

CP 800

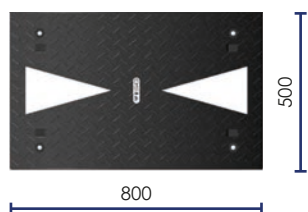
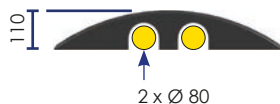

CP 1200

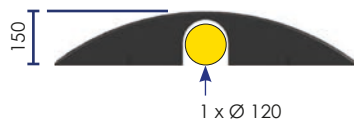

INCLUS ◦ INCLUDED ◦ INCLUIDO ◦ INKLUSIVE



x 4

OPTION ◦ OPTIONAL ◦ OPCIÓN ◦ OPTIONAL



GEY 1 SB

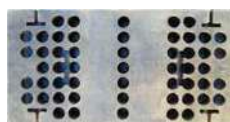

SPIKE 4 SB
Ø 12 x 300



FIX 4 SB
Ø 12 x 130



RQ GLUE



WP 100 / 170

WP 240

PASSE CÂBLE CHANTIER ◦ **WORKSITE CABLE PROTECTOR**
PROTECTOR DE CABLES PARA OBRAS ◦ **KABELBRÜCKE FÜR BAUSTELLE**

-  WP 100 ▶ 1 x Ø 20
-  WP 170 ▶ 1 x Ø 40
-  WP 240 ▶ 1 x Ø 60



+ 60 °C
- 40 °C

CAOUTCHOUC VULCANISÉ
VULCANIZED RUBBER
CAUCHO VULCANIZADO
VULKANISIERTEM KAUSCHUK



INSTALLATION TEMPORAIRE ◦ **TEMPORARY USE** ◦ **USO TEMPORARIO** ◦ **VORÜBERGEHENDE NUTZUNG**

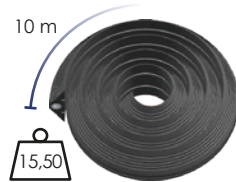

WP 100

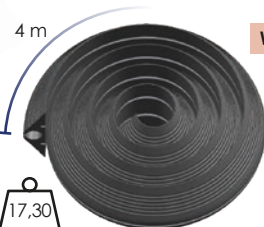
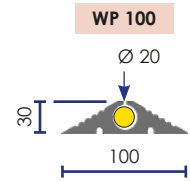

WP 170

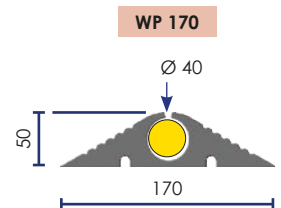

WP 240

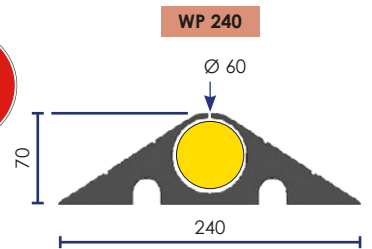

WPR 240

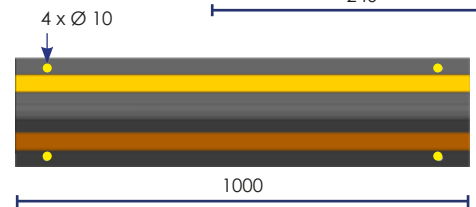

INCLUS ◦ **INCLUDED** ◦ **INCLUIDO** ◦ **INKLUSIVE**

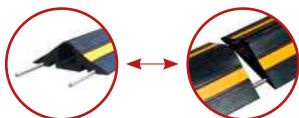

2 liaisons ◦ 2 links
 2 Elementos de unión
 2 Verbindungen
 WP 240



Trous de fixation ◦ Fixation holes
 Agujeros de fijación
 Befestigungslöcher
 WP 240

OPTION ◦ **OPTIONAL** ◦ **OPCIÓN** ◦ **OPTIONAL**



SPIKE WP 244 SB
 WP 240



FIX WP 244 SB
 WP 240



RQ GLUE

SAFETY 100

CP 450

PASSE CÂBLE GRANDE LONGUEUR ◦ EXTRA LONG CABLE BRIDGE PROTECTOR DE CABLE EXTRA LARGO ◦ KABELBRÜCKE MIT GROSSER LÄNGER

1 x Ø 45 + 2 x Ø 20

CAOUTCHOUC VULCANISÉ
 VULCANIZED RUBBER
 CAUCHO VULCANIZADO
 VULKANISIERTEM KAUSCHUK



CP 450 JA



x 4 trous de fixation
 Fixation holes
 Agujeros de fijación
 Befestigungslöcher

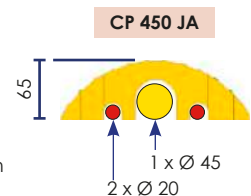

OPTION ◦ OPTIONAL ◦ OPCIÓN ◦ OPTIONAL



SPIKE 4 SB
 Ø 12 x 300



FIX 4 SB
 Ø 12 x 130



RQ GLUE

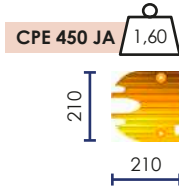

CPE 450 JA

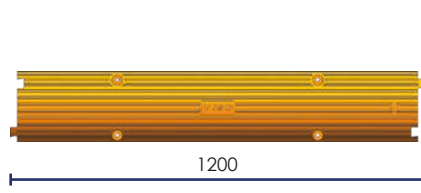

CPR 450 JA

PASSE CÂBLE TRAVERSÉE DE ROUTE ◦ ROAD CROSSING CABLE BRIDGE PROTECTOR DE CABLES PARA CARRETERA ◦ KABELBRÜCKE FÜR STRASSE ÜBERQUERUNG

2 x Ø 50

CAOUTCHOUC VULCANISÉ
 VULCANIZED RUBBER
 CAUCHO VULCANIZADO
 VULKANISIERTEM KAUSCHUK



SCUP 100 N

SAFETY 100 NJ

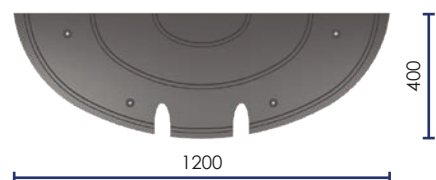
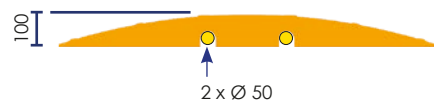

INCLUS ◦ INCLUDED
 INCLUIDO ◦ INKLUSIVE



x 2



x 4 trous de fixation
 Fixation holes
 Agujeros de fijación
 Befestigungslöcher

OPTION ◦ OPTIONAL ◦ OPCIÓN ◦ OPTIONAL



SPIKE 4 SB
 Ø 12 x 300



FSAFE 4 SB
 Ø 12 x 120



RQ GLUE



ZEBRA 65



ZEBRA 100

PASSE CÂBLE TRAVERSÉE DE ROUTE ◦ **ROAD CROSSING CABLE PROTECTOR**
PROTECTOR DE CABLES PARA CARRETERA ◦ **KABELBRÜCKE FÜR STRASSE ÜBERQUERUNG**

ZEBRA 65



CAOUTCHOUC VULCANISÉ
 VULCANIZED RUBBER
 CAUCHO VULCANIZADO
 VULKANISIERTEM KAUSCHUK



Code	Ø Câble	Largeur route ◦ Road width Ancho de carretera ◦ Breite	kg
H 65 mm - Rouge ◦ Red ◦ Rojo ◦ Rot			
CP 2265	65	2,16	264
CP 2765		2,70	330
CP 3265		3,24	396
CP 3865		3,78	462
CP 4365		4,32	528
CP 4865		4,86	594
CP 5465		5,40	660
CP 5965		5,94	726

Ø 65 – 80

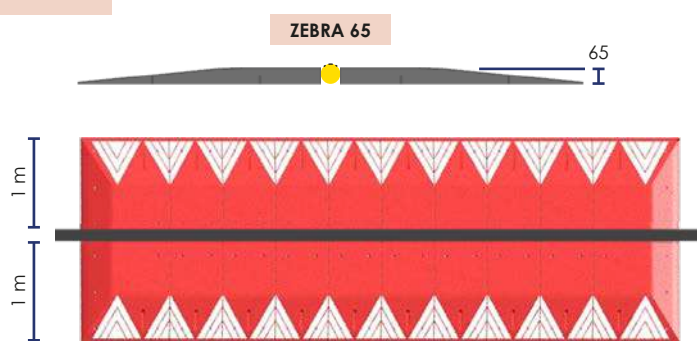

Noir : nous consulter. ◦ Black : ask us. ◦ Negro : consultarnos. ◦ Schwarz : Kontaktieren Sie uns.

ZEBRA 100



CAOUTCHOUC VULCANISÉ
 VULCANIZED RUBBER
 CAUCHO VULCANIZADO
 VULKANISIERTEM KAUSCHUK



Code	Ø Câble	Largeur route ◦ Road width Ancho de carretera ◦ Breite	kg
H 100 mm - Noir ◦ Black ◦ Negro ◦ Schwarz			
CP 22100	100	2,25	375
CP 30100		3,00	500
CP 38100		3,75	625
CP 45100		4,50	750
CP 53100		5,25	875
CP 60100		6,00	1000

Ø 100 – 120

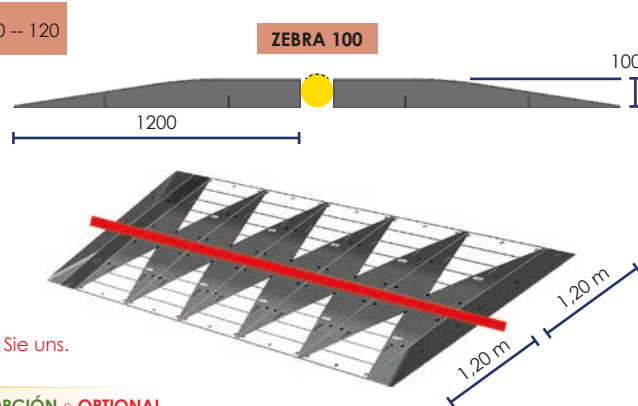

Rouge : nous consulter. ◦ Red : ask us. ◦ Rojo : consultarnos. ◦ Rot : Kontaktieren Sie uns.

INCLUS ◦ INCLUDED ◦ INCLUIDO ◦ INKLUSIVE



OPTION ◦ OPTIONAL ◦ OPCIÓN ◦ OPTIONAL

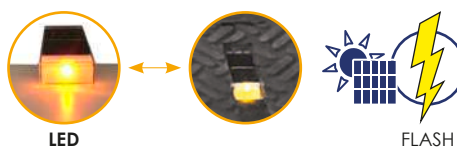





SSC 310 / 370



CSL 700

CÔNE DE SIGNALISATION PLIANT

FOLDABLE REFLECTIVE CONE ◦ CONO PLEGABLE CON LUZ ◦ FALTLITKEGEL



2 x LR03*



1 x CR2032*



Classe 2

* Piles non fournies ◦ Batteries not supplied
Baterías no incluidas ◦ Batterien nicht enthalten

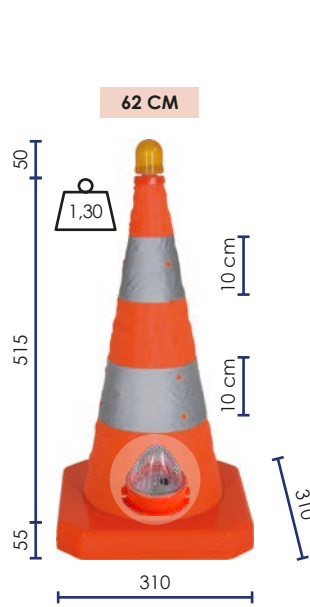

SSC 310

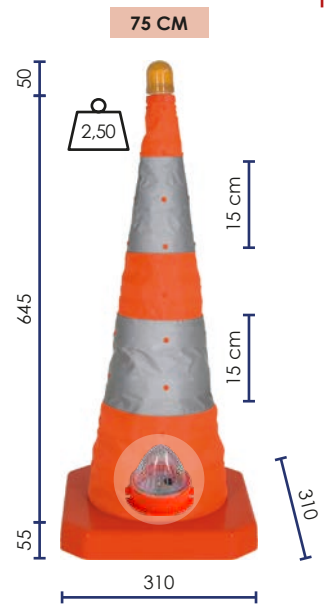

SSC 370

BALISE DE RUE

BLACK CUSTOMIZABLE CONE ◦ BALIZA ◦ STRASSEN LEITBAKE



Classe 1
Class 1
Clase 1
Klasse 1



Réfléchissant
Reflective
Reflectante
Reflektierende



50 x 20



Personnalisation : mini 100
Customization mini 100
Personalización mini 100
Personalisierung : Mini 100

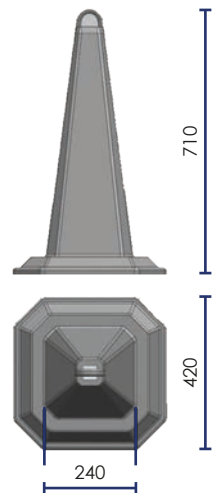



RC **CLASSE 2**

CLASSE 1 CSC

CÔNE RÉFLÉCHISSANT CLASSE 1

TRAFFIC CONE ◦ CONO DE SEÑALIZACIÓN ◦ REFLEKTIERENDER LEITKEGEL



Bandes réfléchissantes classe 1
Reflective tape class 1
Bandas reflectantes classe 1
Reflektierende Streifen Klasse 1



CSC 301 : Ø 45 mm
CSC 501 : Ø 45 mm
CSC 751 : Ø 31 mm

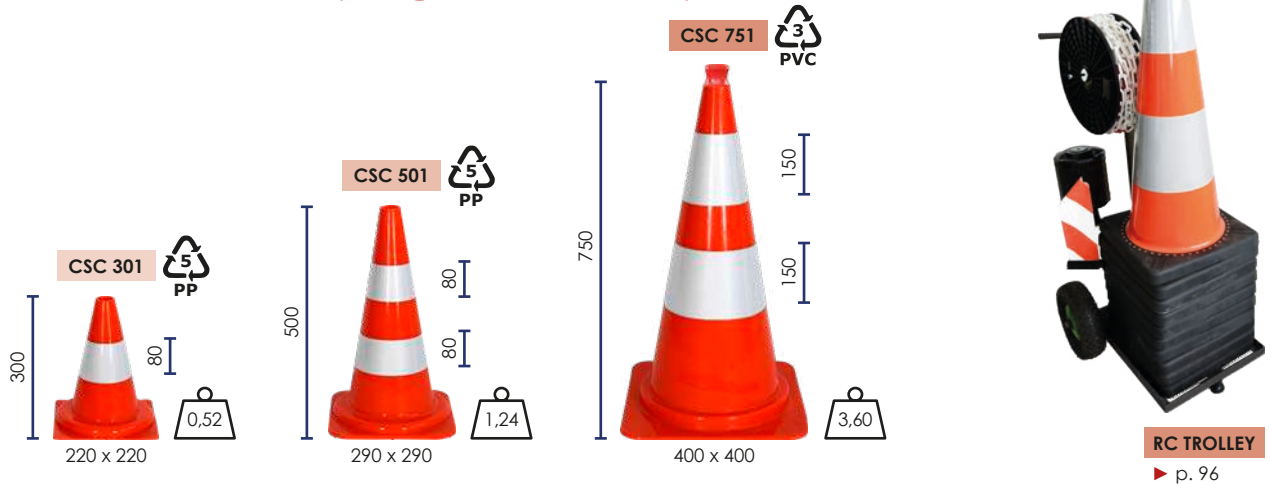

CÔNE LESTÉ CLASSE 2. EN 13422

HEAVY DUTY CONE ◦ CONO CON BASE CAUCHO ◦ LEITKEGEL - STANDFUSS SCHWER



Base
Base
Base
Standfuß

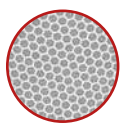

Bandes réfléchissantes classe 2
Reflective tape class 2
Bandas reflectantes classe 2
Reflektierende Streifen Klasse 2



300 m

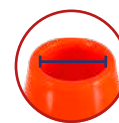

RC 300 : Ø 28 mm
RC 500 : Ø 30 mm
RC 752 : Ø 39 mm
RC 1000 : Ø 39 mm

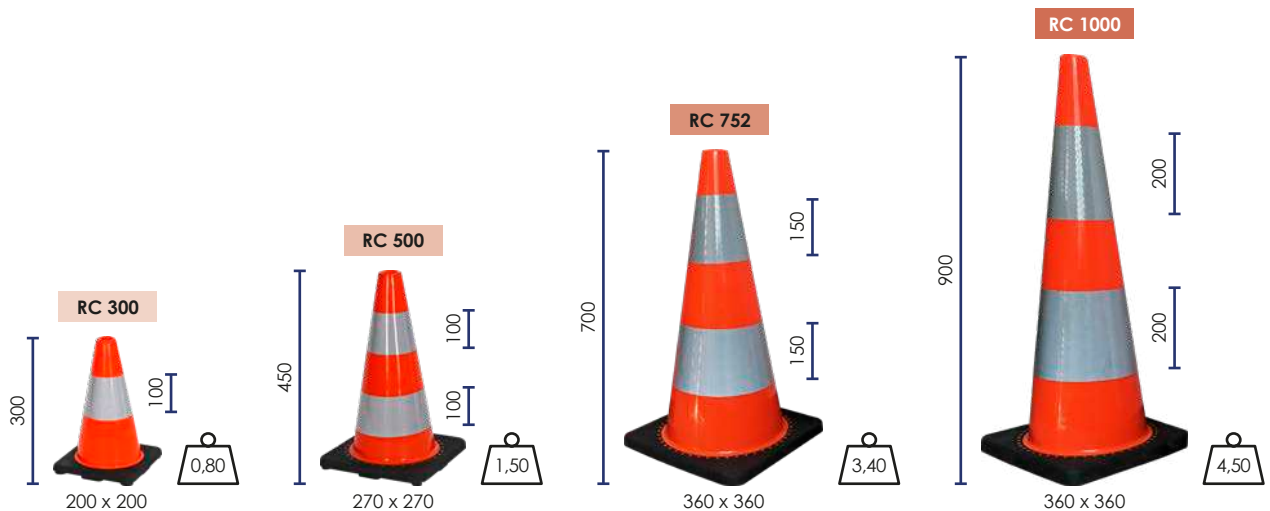

HAUTEUR ◦ **HEIGHT** ◦ **ALTURA** ◦ **HÖHE**



70 CM

90 CM

COULEUR ◦ **COLOR** ◦ **COLOR** ◦ **FARBE**



Choix des couleurs uniquement pour les cônes 90 cm
 Color's choice only for 90 cm cones
 Elección de colores solamente para conos de 90 cm
 Farbwahl nur für Leitkegel 90 cm



Base
Base
Base
Standfuß



Ø 39 mm



PVC souple
Flexible PVC
PVC flexible
Flexibel PVC



Base caoutchouc
360 x 360 mm
Rubber base
Base de caucho
Gummi Standfuß

Réfléchissant
Reflective
Reflexivo
Reflektierend

CLASSE 2. EN 13422



Base caoutchouc
Rubber base
Base de caucho
Gummi Standfuß



Base vide à lester
550 x 550 mm
Empty base to be loaded
Base de lastre vacía

Leerer Sockel zum beschweren

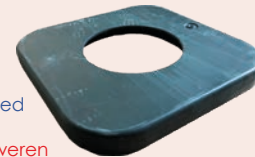

3. COLORIS DE SANGLE ◦ **BELT COLOR** ◦ **COLOR DE CINTA** ◦ **FARBE DES GURTES**

2 M X 50 MM
4 M X 50 MM



STOP



10 M X 50 MM
4 M X 100 MM
10 M X 100 MM



▲ Sangle personnalisée (sauf 10 m), nous consulter.
 Customized belt (except 10 m), consult us.
 Cinta personalizada (salvo 10 m), consultarnos.
 Gurt Personalisierung (außer 10 m), uns konsultieren.



ENROULEURS

RETRACTABLE BELT BARRIER ◦ ENROLLADOR DE CINTA ◦ ABSPERRGURT

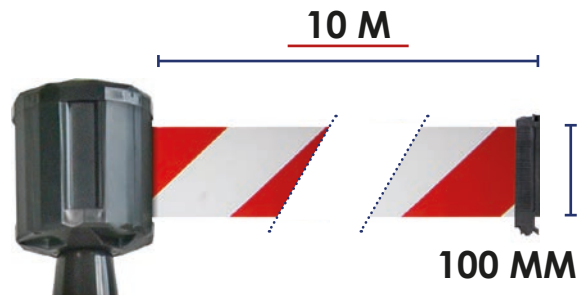
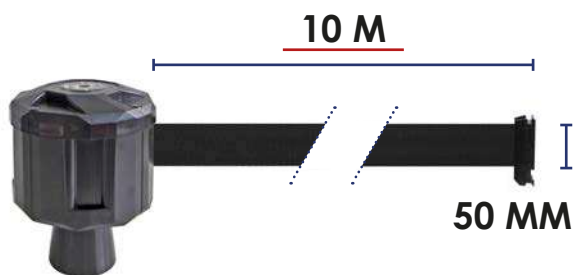
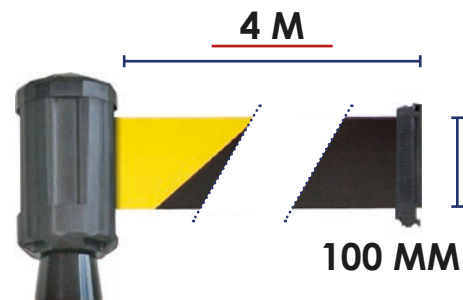
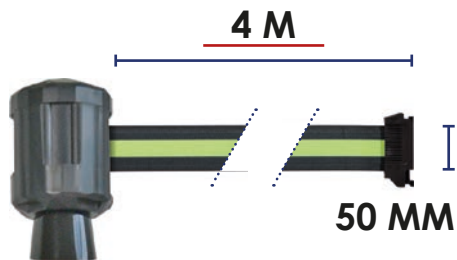
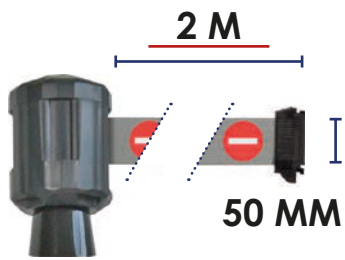

4. OPTIONS ◦ OPTIONS ◦ OPCIONES ◦ OPTIONEN

BOITIER RÉCEPTEUR VIDE

EMPTY RECEIVER BOX
CAJA RECEPTORA SIN CINTA
LEERES EMPFANGSBOX



PANNEAUX A3 ET A4

A3 AND A4 PANELS
PANELES A3 Y A4
PANEEL A3 UND A4



STICKERS ◦ STICKERS ◦ ADHESIVOS ◦ AUFKLEBER

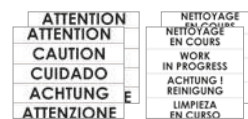

CLASSE 2. EN 13422



Cône ○ Cone
Cono ○ Leitkegel

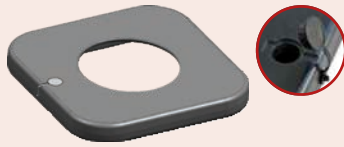

Base vide à lester
550 x 550 mm
Empty base to be loaded
Base de lastre vacia
Leerer Standfuß zu beschweren



Adaptateur
Connector
Adaptador
Adapter



Enrouleur
Retractable barrier
Enrollador de cinta
Abspergurt

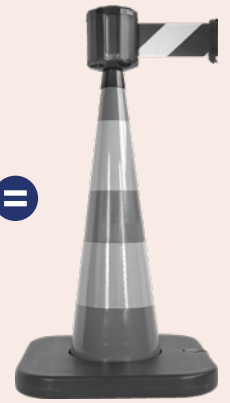

85 CM

Longueur sangle
Belt length
Largo de cinta
Gurtlänge



85 cm

2 M

RCX72RE

RCX72RB

RCX72ENT

50 MM

4 M

RCX74RE

RCX74RB

RCX74ENT

10 M

RCX105RE

RCX105RB

90 CM



90 cm

4 M

RCX741RE

RCX741RB

100 MM

10 M

RCX110RE

RCX110RB

CLASSE 2. EN 13422

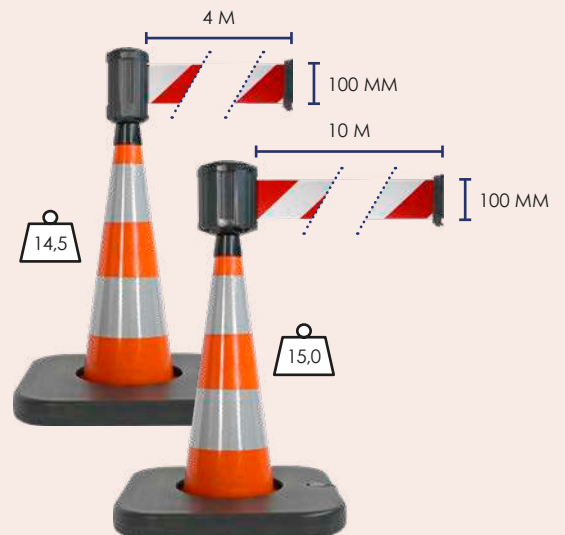
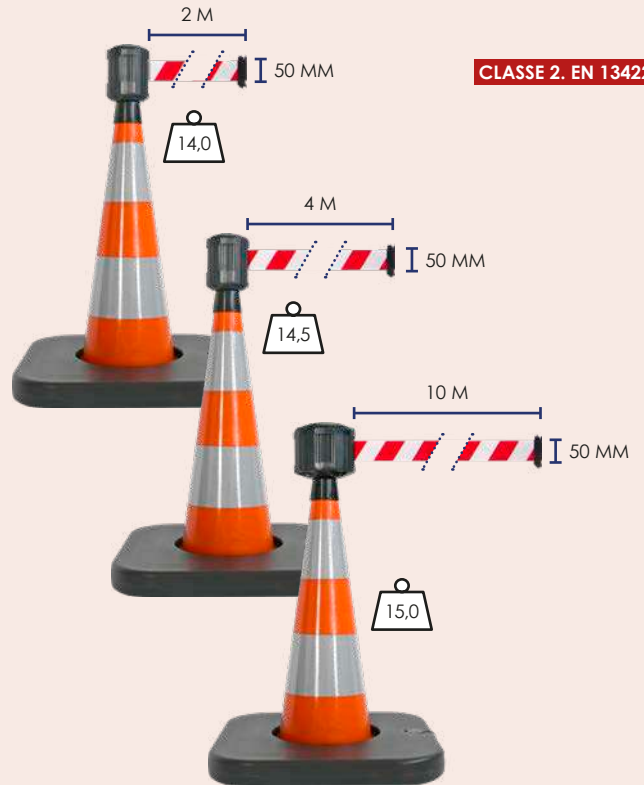



105 CM

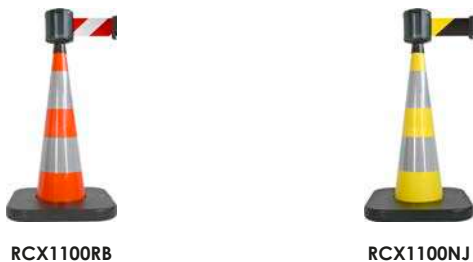
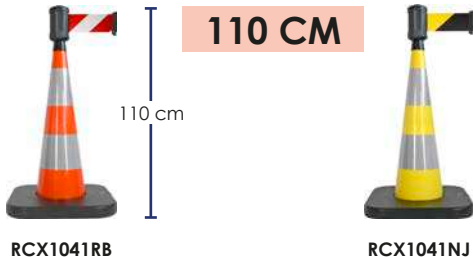



BOITIER RÉCEPTEUR VIDE UNIVERSEL*

EMPTY RECEIVER BOX ◦ CAJA RECEPTORA SIN CINTA ◦ LEERE EMPFANGSBX

Code	Pour ◦ For Para ◦ Für
RCBOX VID 24	RCX 2 / RCX 4
RCBOX VID 410	RCX 410
RCBOX VID 105	RCX 1050
RCBOX VID 110	RCX 1100



Peut recevoir jusqu'à 3 sangles ◦ Can receive up to 3 belts
Puede recibir hasta 3 cintas ◦ Kann bis zu 3 Gurte aufnehmen



ENROULEUR UNIVERSEL*

UNIVERSAL RETRACTABLE BARRIER ◦ ENROLLADOR DE CINTA ◦ UNIVERSELL ABSPERRGURT

2 M X 50 MM

RCBOXBK2	●	RCBOXRB2	◐
RCBOXRE2	●	RCBOXNJ2	◑
RCBOXBU2	●	RCBOXBY2	◒
RCBOXGR2	●	RCBOXENT2	◓
RCBOXJA2	●	RCBOXDAN2	◔
RCBOXVE2	●	RCBOXBBR2	◕
RCBOXSTOP2	STOP ◐ STOP	RCBOXSECOURS2	ISSUE DE SECOURS

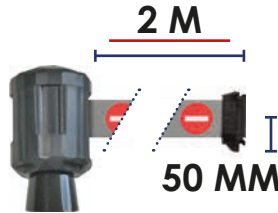

RCUNIVERSAL
Adaptateur
Connector
Adaptador
Adapter



4 M X 50 MM

RCBOXBK4	●	RCBOXRB4	◐
RCBOXRE4	●	RCBOXNJ4	◑
RCBOXBU4	●	RCBOXBY4	◒
RCBOXGR4	●	RCBOXENT4	◓
RCBOXJA4	●	RCBOXDAN4	◔
RCBOXVE4	●	RCBOXBBR4	◕
RCBOXSTOP2	STOP ◐ STOP	RCBOXSECOURS2	ISSUE DE SECOURS

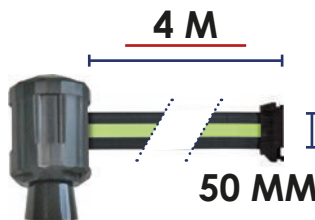

4 M X 100 MM

RCBOXBK410	●
RCBOXRE410	●
RCBOXRB410	◐
RCBOXNJ410	◑

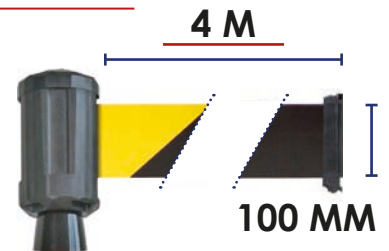

10 M X 50 MM

RCBOXBK105	●
RCBOXRE105	●
RCBOXRB105	◐
RCBOXNJ105	◑

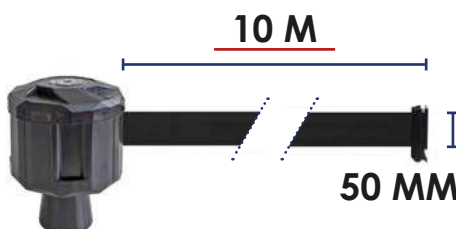

10 M X 100 MM

RCBOXBK110	●
RCBOXRE110	●
RCBOXRB110	◐
RCBOXNJ110	◑

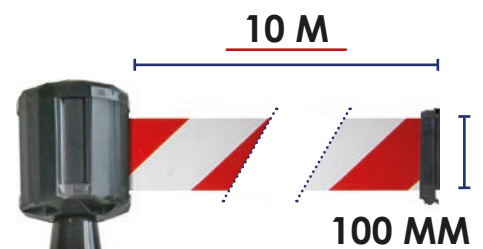

* Compatible tous cônes ◦ Compatible with all cones ◦ Compatible con todos los conos ◦ Kompatibel mit allen Kegeln
Récepteur mural ▶ p. 222 ◦ Wall receiver ▶ p. 222 ◦ Receptor mural ▶ p. 222 ◦ Wandempfänger ▶ p. 222

AFFICHAGE ◦ SIGN BOARD ◦ PORTA CARTEL ◦ INFOTAFEL



Code
RCPNX A4
RCPNX A3

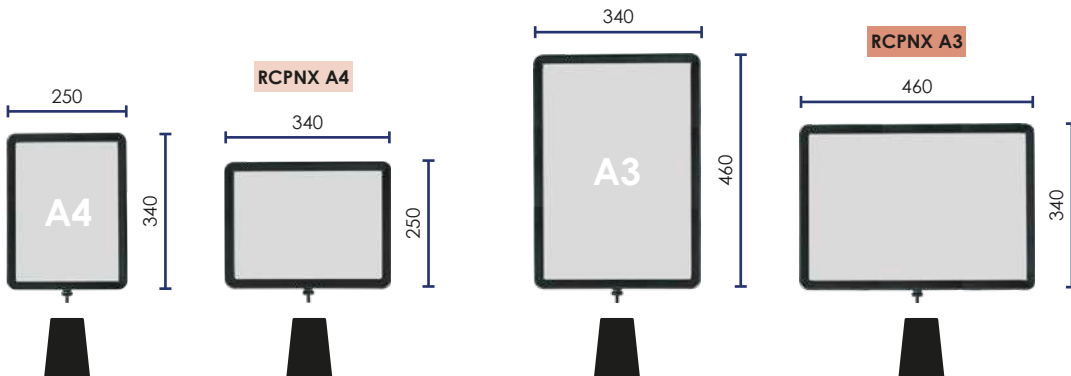
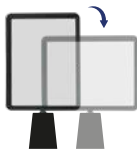

BASE ◦ BASES ◦ BASES ◦ STANDFUß

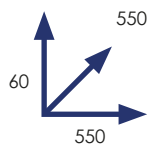

Base lestée béton
Concrete loaded base
Base lastrada con hormigón
Beton beschwertem standfuß



Base vide à lester
Empty base to be loaded
Base de lastre vacía
Leerer standfuß zum beschweren



RCBASE LO



RCBASE VD



STICKER ◦ STICKERS ◦ ADHESIVOS ◦ AUFKLEBER

Lot de 2 stickers 210 x 210 mm
Set of 2 stickers
Lote de 2 adhesivos
Set von 2 Stickern



STICKINTERDIT



STICKCHUTE



STICKNOPARK

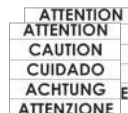

STICKTEXT1

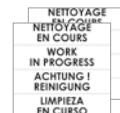

STICKTEXT2



STICKNOPIETON



STICKCHANTIER



STICKDANGER



STICKELECT



STICKNOPASS



RC LAMPSOL 180

► RC 752 / 1000



FLASH 90

► RC 752 / 1000



RC 101 FLASH

► RC 752 / 1000



RC 101 FLASH x 1

RC 106 FLASH x 6

RC TROLLEY

10 / 20 Cônes suivant modèle ◦ 10 / 20 depending on the type ◦ 10 / 20 conos según modelo ◦ Leikegel nach Modell

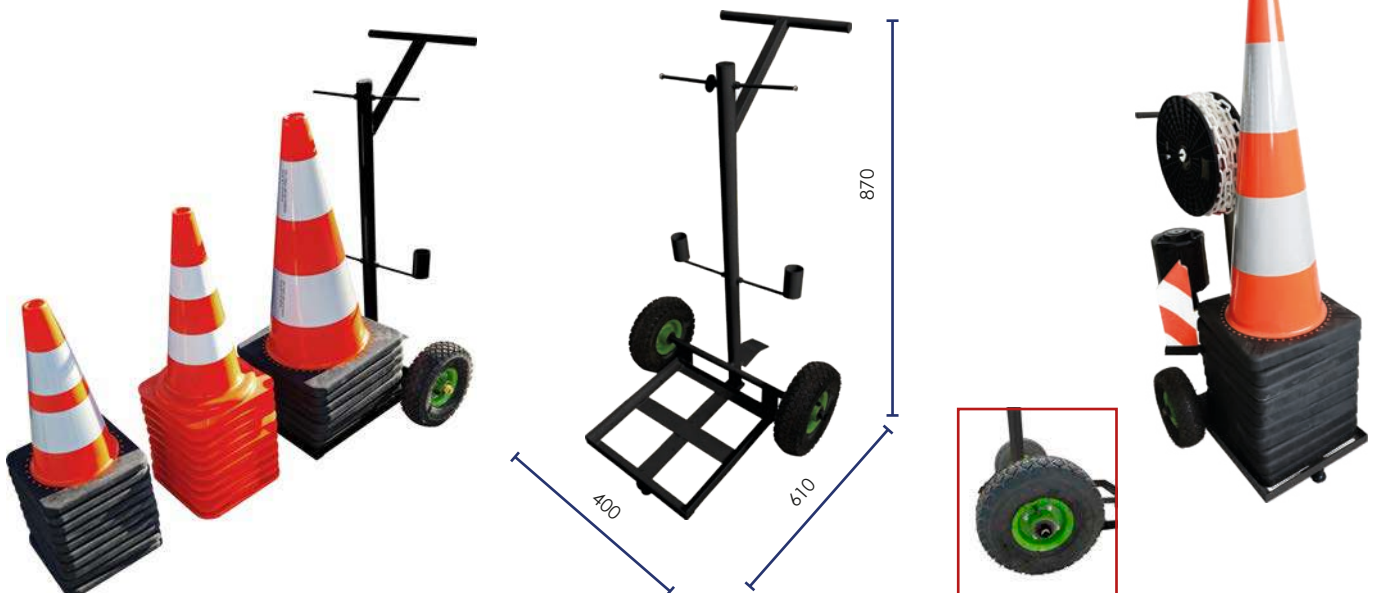

BARRES EXTENSIBLES ◦ EXPANDING BARRIERS ◦ BARRAS EXTENSIBLES ◦ TELESKOPSTANGE

Compatible tous cônes
Compatible with all cones ◦ Compatible con todos los conos ◦ Kompatibel mit allen Kegeln

Code	
RC BAR215 RB	
RC BAR215 NJ	
RC BAR215 BU	
RC BAR215 VE	



Bandes réfléchissantes classe 1
Reflective tape class 1
Bandas reflectantes clase 1
Reflektierende Streifen Klasse 1

Verrouillage à la longueur désirée
Blocking device at chosen length
Bloqueo a la longitud elegida
Sperrvorrichtung in gewählter Länge

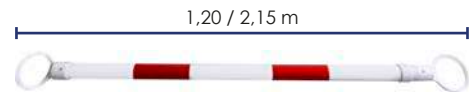

BARRES ◦ BARRIERS ◦ BARRAS ◦ PLANKEN

Compatible tous cônes
Compatible with all cones ◦ Compatible con todos los conos ◦ Kompatibel mit allen Kegeln

EXTENSIBLES
EXPANDABLE
EXTENSIBLE
TELESKOPISCH

Bandes réfléchissantes classe 1
Reflective tape class 1
Bandas reflectantes clase 1
Reflektierende Streifen Klasse 1

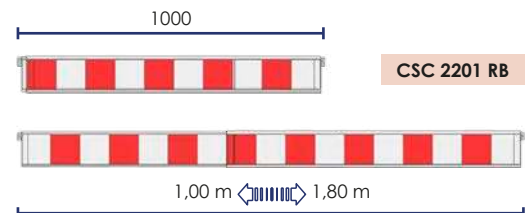
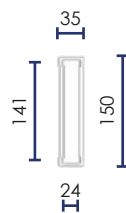
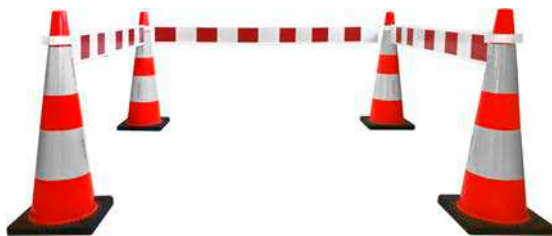

CHAÎNES ◦ CHAINS ◦ CADENAS ◦ KETTEN

Compatible tous cônes
Compatible with all cones ◦ Compatible con todos los conos ◦ Kompatibel mit allen Kegeln

Code		
CBR 801 SBS		25 m x Ø 8
CNJ 801 SBS		
CBB 801 SBS		
CBV 801 SBS		



Code
CS RING 5 SB



x 5



PRESSING

ROY
CHOCOLATIER

CLAW
THANKS
ZAPATAS

PROF. ANTONI



RR

ZE

RAMPES

RAMPS ◦ RAMPAS ◦ BORDSTEIN-RAMPEN



+ 60 °C
- 40 °C



CAOUTCHOUC VULCANISÉ
VULCANIZED RUBBER
CAUCHO VULCANIZADO
VULKANISIERTEM KAUSCHUK



RR

Code	H	I	kg	Icon
RR 35	35	300	6,50	4
RR 100	100	300	12,00	4
RR 150	150	360	19,00	4
RR 200	200	450	32,00	4
RRD 35	35	300	2,00	2
RRD 100	100	300	4,00	2
RRD 150	150	360	8,00	2
RRD 200	200	450	17,00	2

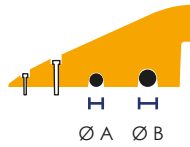

Code	Ø A	Ø B
RR / RRD 35	-	10
RR / RRD 100	25	30
RR / RRD 150	30	35
RR / RRD 200	35	40

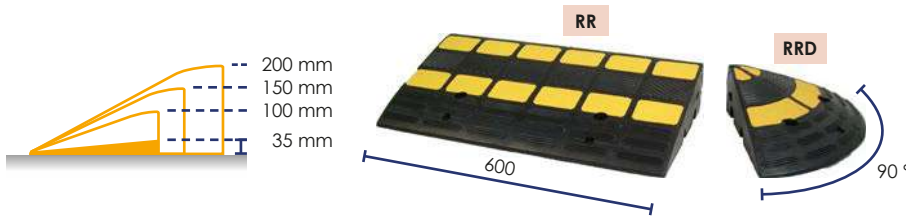
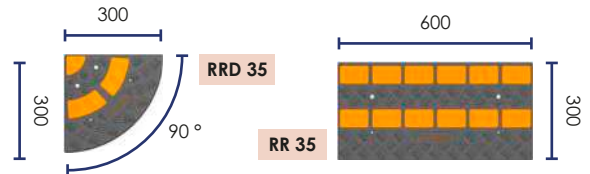

OPTION ◦ OPTIONAL ◦ OPCIÓN ◦ OPTIONAL



RR FIX 4 SB
2 x Ø 6
2 x Ø 10



RR SPIKE 4 SB
2 x (Ø 7 x 300)
2 x (Ø 10 x 300)



RQ GLUE

ZE

Code	Icon 1	Icon 2	kg
ZE 100 RAMP	6	7	55
ZE 100 END	3	5	23
ZE 25 G	3	3	17
ZE 25 D	3	3	17

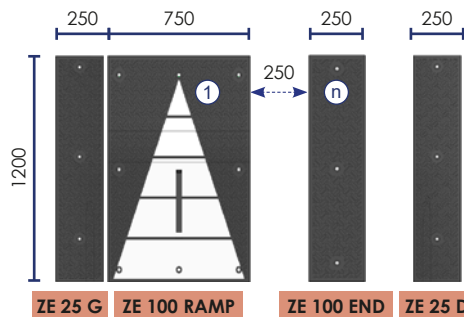

INCLUS ◦ INCLUDED ◦ INCLUIDO ◦ INKLUSIVE



FIX 1 SB
Ø 12 x 130

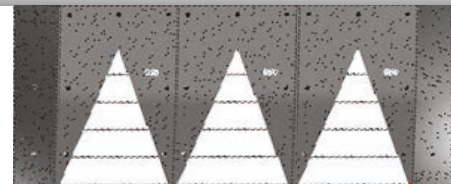

ZE 25 G ZE 100 RAMP

ZE 25 D



RR



PLAQUE DE CHAUSSÉE

ROAD PLATE ◦ RAMPA PARA ZANJAS ◦ ÜBERFAHRPLATTE



CAOUTCHOUC VULCANISÉ
VULCANIZED RUBBER
CAUCHO VULCANIZADO
VULKANISIERTEM KAUSCHUK



Code		
RR 1400	1400 x 800 x 50	18
RR 1700	1700 x 1000 x 50	20
RR 2060	2000 x 600 x 50	23

Emboitable ◦ Expandable ◦ Encajable ◦ Dehnbare



Jonction
Junction
Junta
Verbindung

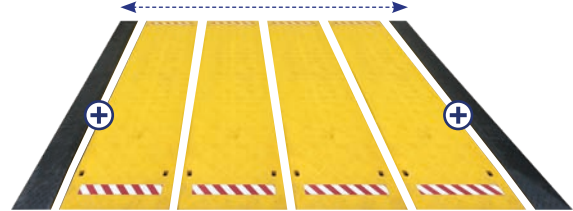

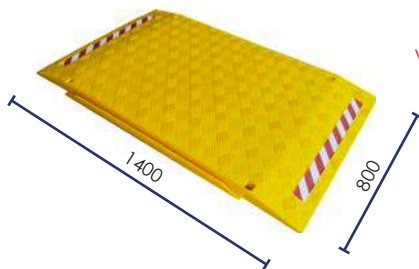

RR 1400

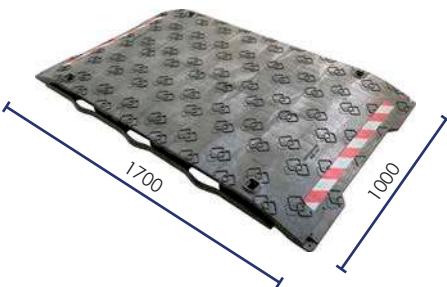

RR 1700



RR 2060

	
0,5 m	20000
0,7 m	10000
0,9 m	5000
1,2 m	1000

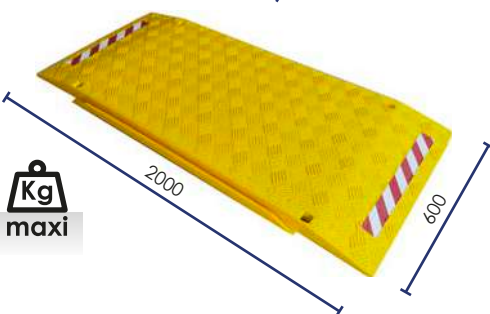

Patins anti-glisse
Non skid pad
Tapa antideslizante
Rutschfest



Renforts acier
Steel reinforcement
Refuerzos de acero
Stahlverstärkungen

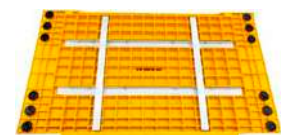

Poignée de transport
Transport handle
Asa de transporte
Handgriff



Trous de fixation
Fixation holes
Agujeros de fijación
Befestigungslöcher

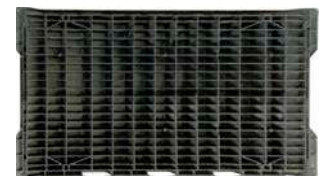

Patins anti-glisse
Non skid pad
Tapa antideslizante
Rutschfest

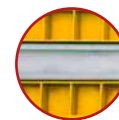

Renforts acier
Steel reinforcement
Refuerzos de acero
Stahlverstärkungen

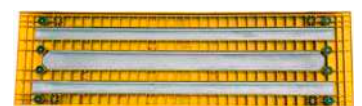

OPTION ◦ OPTIONAL ◦ OPCIÓN ◦ OPTIONAL



RR 1401 ▶ RR 1400
RR 2001 ▶ RR 2060



RR 1701 ▶ RR 1700



RR 1400 M ▶ RR 1400
RR 2060 M ▶ RR 2060



RR 1400 F ▶ RR 1400
RR 2060 F ▶ RR 2060



PASS

PASSERELLE ◦ FOOTBRIDGE ◦ PASARELA ◦ BRÜCKE



Jonction Emboitable
 Junction Expandable
 Junta Encajable
 Verbindung Dehnbare



740*

PASS 800



1460*

PASS 1600



2200*

PASS 2400

1000
maxi



859*

PASS 1708



1859*

PASS 1718



2859*

PASS 1728

1000
maxi

Code	L	* mm	kg
PASS 800	1400	740	26,5
PASS 1600		1460	48,5
PASS 2400		2200	63,0
PASS 3200		2940	81,0
PASS 1708	1700	859	38,0
PASS 1718		1859	60,0
PASS 1728		2859	82,0
PASS 2010	2000	1030	55,0
PASS 2018		1630	84,0
PASS 2024		2230	107,0



1030*

PASS 2010



1630*

PASS 2018

Kg
maxi

kg	maxi
0,5 m	20000
0,7 m	10000
0,9 m	5000
1,2 m	1000

* Passage utile ◦ Useful width ◦ Ancho útil ◦ Nützliche Passage



COUVERTURE DE TRANCHÉES

TRENCH COVER PLATE ◦ PLACA CUBRE ZANJAS ◦ GRABENABDECKUNGEN



RR 1280

	Kg maxi
1,1 m	350
0,9 m	500
0,7 m	600
0,5 m	700

Kg
maxi

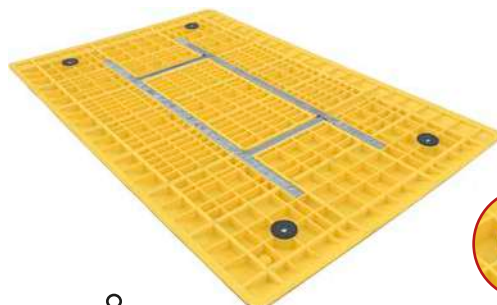

14



Renforts acier
Steel reinforcement
Refuerzos de acero
Stahlverstärkungen



Patins anti-glisse
Non skid pad
Tapa antideslizante
Rutschfest

1220



800

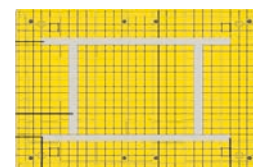

240

890



I 8



RR 1612

	Kg maxi
1,1 m	350
0,9 m	500
0,7 m	600
0,5 m	700

Kg
maxi



25



Renforts acier
Steel reinforcement
Refuerzos de acero
Stahlverstärkungen



Patins anti-glisse
Non skid pad
Tapa antideslizante
Rutschfest

1620



1220

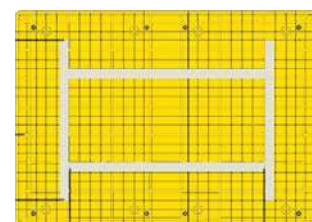

880

1050



I 30





RAMP

ADJ 1100

RAMPE D'ACCÈS TRANSPORTABLE

TRANSPORTABLE ACCESS RAMP ◦ RAMPA DE ACCESO PORTÁTIL ◦ MOBILE RAMPEN

Code		kg maxi	kg
ADJ 1100	1120 (1010) x 750 x 160	300	9

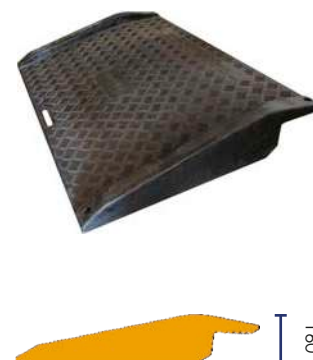
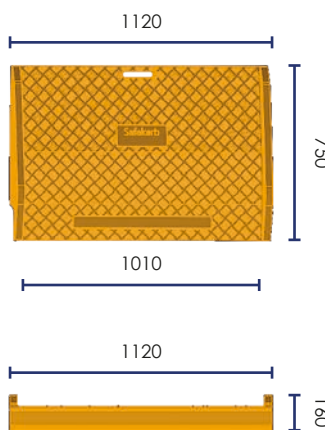

PLIANTES ◦ FOLDABLE ◦ PLEGABLE ◦ FALTBARE

Code		kg maxi	kg
RAMP 125	1220 x 710 x 50	300	9,2
RAMP 178	1830 x 710 x 50	300	13,8



Bavette ajustable
Adjustable plate
Placa ajustable
Einstellbarer Schaufel

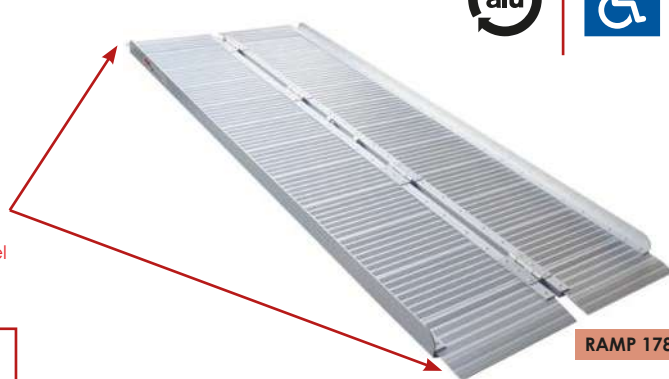

RAMP 178

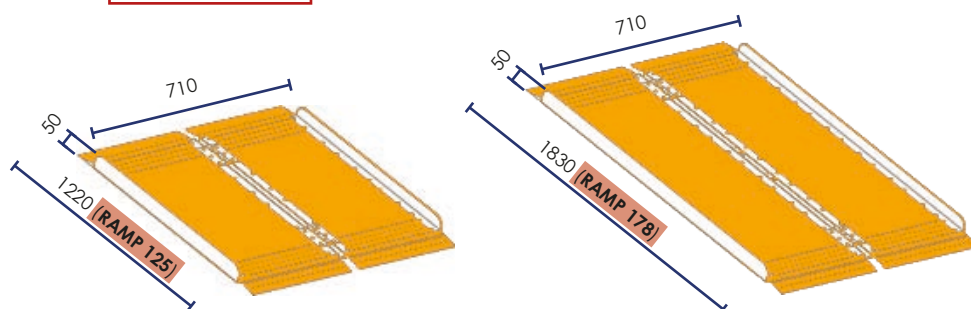



BALISAGE ◦ MARKING ◦ SEÑALIZACIÓN ◦ WARNMARKIERUNG

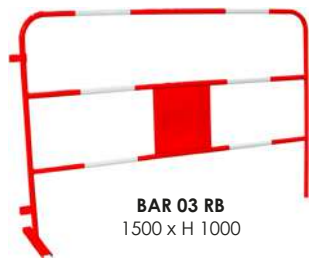

BAR 03 RB
1500 x H 1000

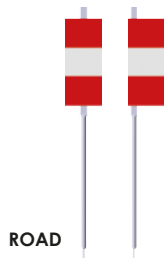

ROAD



GPP 501



TRIAK



AK5 LED

HAUTE VISIBILITÉ
HIGH VISIBILITY
ALTA VISIBILIDAD
HOHER SICHTBARKEIT

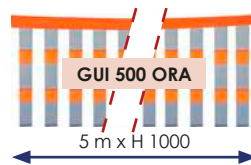

GUI 500 ORA

5 m x H 1000

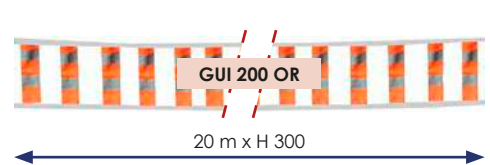

GUI 200 OR

20 m x H 300

BARRIÈRE EXTENSIBLE ◦ EXPANDABLE BARRIER ◦ BARRERA EXTENSIBLE ◦ ABSPERR-SCHERENGITTER



2,30 m

BAR 001 RB

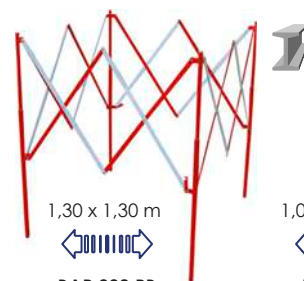

1,30 x 1,30 m

BAR 002 RB

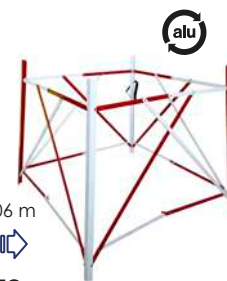

1,06 x 1,06 m

BARELEC



3,00 m

BAR 3000

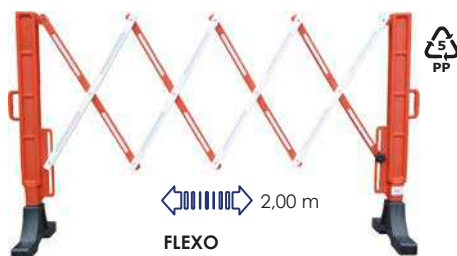

2,00 m

FLEXO



2,40 m

EXTENSO

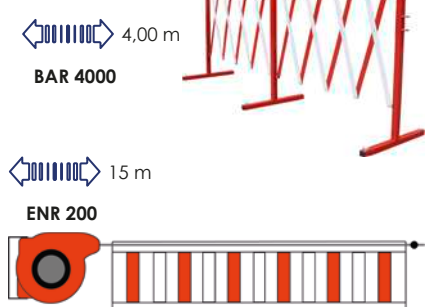

4,00 m

BAR 4000

15 m

ENR 200

BARRIÈRES POLYPROPYLENE

POLYPROPYLENE BARRIERS ◦ BARRERAS DE POLIPROPILENO ◦ SPERRGITTER



BAR 1020 OR
1200 x H 1000



BAR 2020 GR SP
2000 x H 1000



BAR 2020 OR
2000 x H 1000



BAR 134 OR



BAR 234 OR



BAR 244 GR



AK5 LED



CLASSE 1

CLASSE 2



TRIAK

PANNEAU SOLAIRE A LED

SOLAR LED TRAFFIC SIGN ◦ **PANEL DE TRAFICO CON LED** ◦ **LEUCHTTAFELN**



Informations techniques, voir page 35
 Technical specifications see page 35
 Datos técnicos ver página 35
 Technische Informationen, siehe Seite 35



AK5 LED



INCLUS ◦ **INCLUDED** ◦ **INCLUIDO** ◦ **INKLUSIVE**



CLASSE 2

Ø 60 / 8 led Ø 5 mm

TRIPODE PLIABLE

FOLDABLE TRIPOD ◦ **TRIPODE PLEGABLE** ◦ **DREIBEINIGEN FALTSIGNAL**



TRIAK5 BL

TRIAK14 BL

Système de ressort parapluie
 Umbrella spring system
 Sistema de resorte tipo paraguas
 Regenschirm-Federsystem

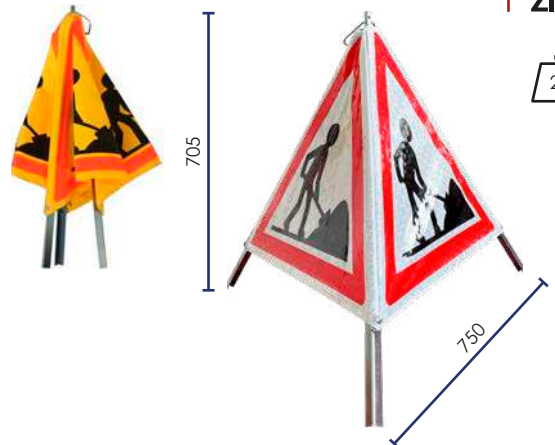

TRIAK5

TRIAK14

TRIGEO

TRIFAU

INCLUS ◦ **INCLUDED** ◦ **INCLUIDO** ◦ **INKLUSIVE**

Toile PP enduit PVC
 PP fabric and PVC coating
 Tela PP cubierto con PVC
 PVC beschichtete Polyestergerewebe



CLASSE 1

CLASSE 2

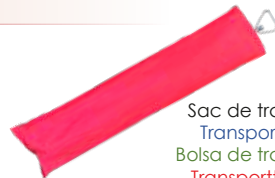

Sac de transport
 Transport bag
 Bolsa de transporte
 Transporttasche

OPTION
OPTIONAL
OPCIÓN
OPTIONAL

Personnalisation
 Customization
 Personalización
 Personalisierung

mini 50



BALISAGE ◦ MARKING ◦ SEÑALIZACIÓN ◦ WARNMARKIERUNG

BARRIÈRE DE CHANTIER ◦ BARRIER ◦ BARRERA ◦ ABSPERRUNGEN

BAR 03 RB

Plaque personnalisable
Customizable plate
Placa personalizable
Personalisierbare Platte



minimum de commande : 5 ◦ MOQ = 5 pcs
Pedido mínimo : 5 ◦ Mindestbestellmenge: 5

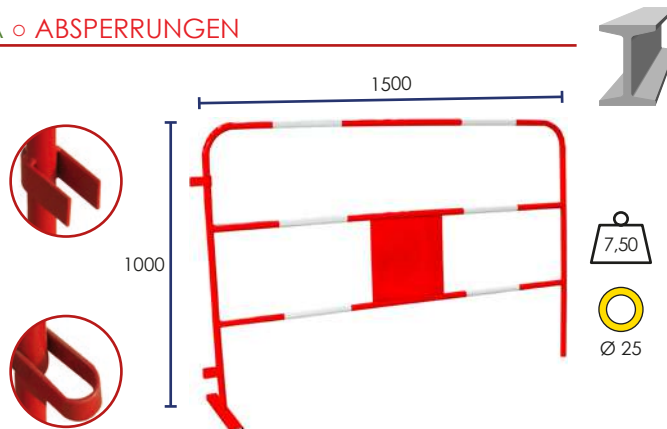

PIQUET ◦ REFLECTIVE POSTS ◦ POSTE REFLECTIVO ◦ LEITBAKE

Code	Face(s)	Classe	
ROAD 1011	1	1	x 10
ROAD 1021	2	1	
ROAD 1012	1	2	
ROAD 1022	2	2	

Angles arrondis
Rounded corners
Esquinas redondeadas
Abgerundeten Ecken

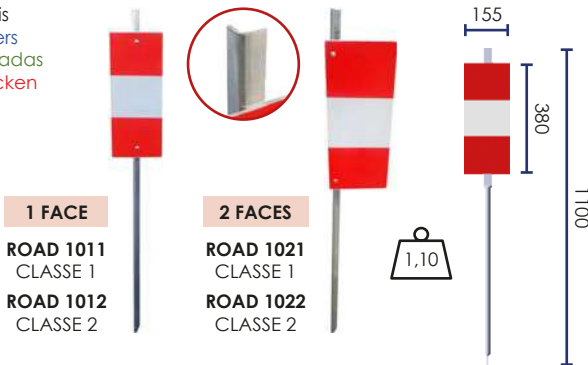

ZINGUÉ
ZINC
ZINCADO
VERZINKTE

GRILLAGE ◦ FENCE ◦ MALLA DE PROTECCIÓN ◦ FLEXIBLER ZAUN / ABSPERRNETZ

PFR 520 SB



SP 1205 SB

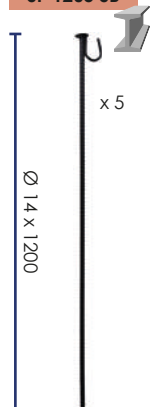

GPP 501

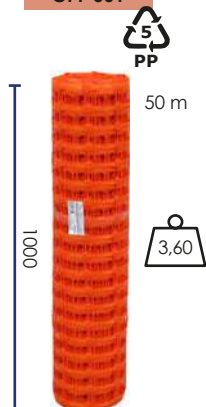

115 x 50
Maille
Mesh
Malla
Masche





BAR 001 RB

BARELEC

BAR 002 RB

BARRIÈRE EXTENSIBLE

EXPANDABLE BARRIER ◦ BARRERA EXTENSIBLE ◦ ABSPERR-SCHERENGITTER

BAR 001 RB 2,30 m

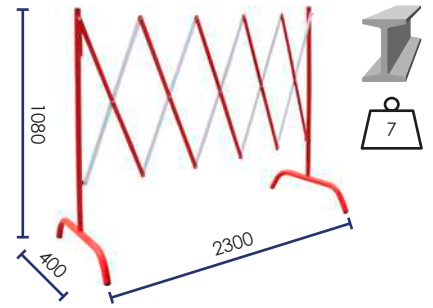
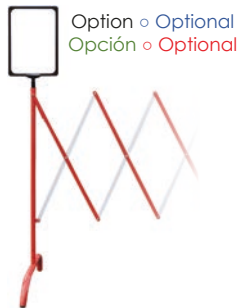

BAR 002 RB 1,30 x 1,30 m

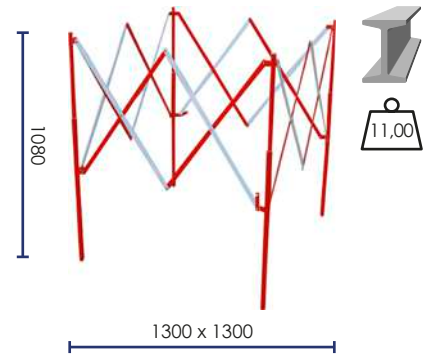
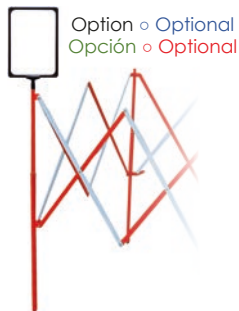

BARELEC 1,06 x 1,06 m

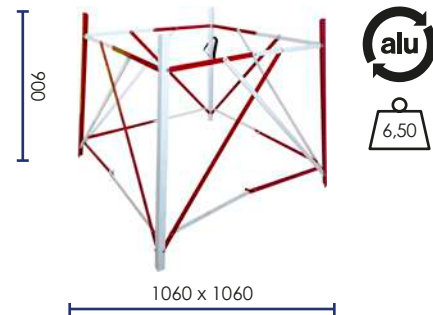
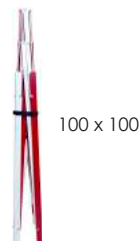

OPTION ◦ OPTIONAL ◦ OPCIÓN ◦ OPTIONAL



BAR 02 BAG
BARELEC
BAR 002



BAR 01 BAG



RS A4 PN
BAR 001
BAR 002

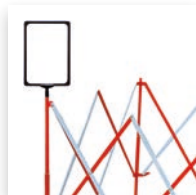



BAR 4000



BAR 3000

BARRIÈRE EXTENSIBLE ◦ **EXPANDABLE BARRIER**
BARRERA EXTENSIBLE ◦ **SCHERRENSPERREN**



Code	
BAR 3000 RB	
BAR 3000 BK	

3,00 m



BAR 3000 BK

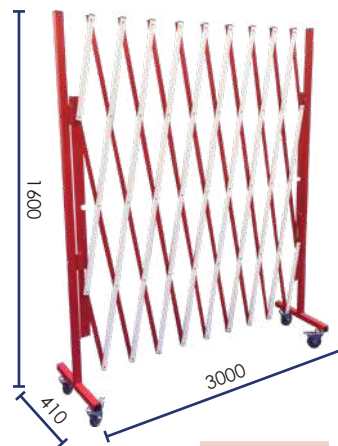

BAR 3000 RB



BAR 3 EXT RB

Code	
BAR 3 EXT RB	
BAR 3 EXT BK	

3,00 m



Ø 80

Code	
BAR 4000	
BAR 4000 NJ	
BAR 4000 BK	

4,00 m

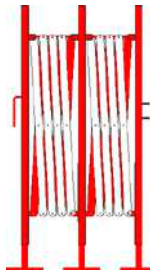

BAR 4000

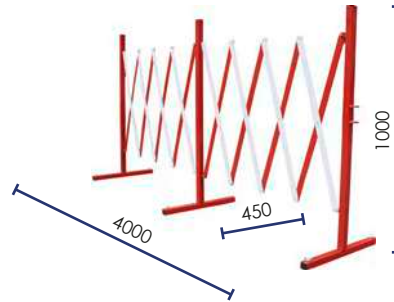

Code	
BAR 4006 RB	
BAR 4006 NJ	
BAR 4006 BK	

4,00 m



Frein
Brake
Freno
Bremse



WH 501 SB
Ø 50 mm



BAR 4006 RB

OPTION ◦ **OPTIONAL** ◦ **OPCIÓN** ◦ **OPTIONAL**

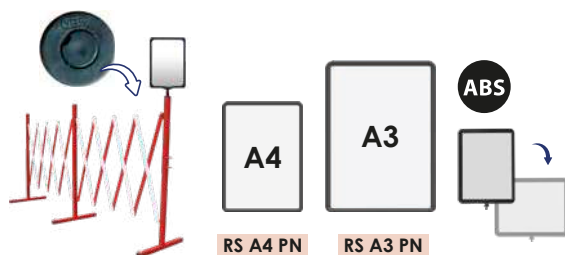

RS A4 PN

RS A3 PN

ABS

Frein
Brake
Freno
Bremse



WH 501 SB
Ø 50 mm

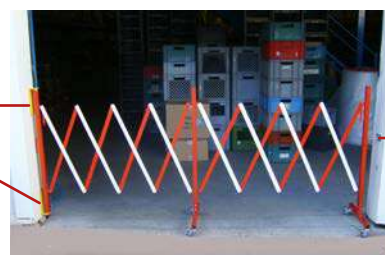

BAR 4 KIT

Kit de fixation murale ◦ Wall fixing kit
Kit de fijación a la pared
Wandbefestigungsset





FLEXO



EXTENSO

BARRIÈRE EXTENSIBLE ◦ **EXPANDABLE BARRIER**
BARRERA EXTENSIBLE ◦ **ABSPERR-SCHERENGITTER**



FLEXO ◀▶ 2,00 m

Code		
FLEXO 200 RB		4,80
FLEXO EXTRB		3,40
FLEXO 200 NJ		4,80
FLEXO EXTNJ		3,40

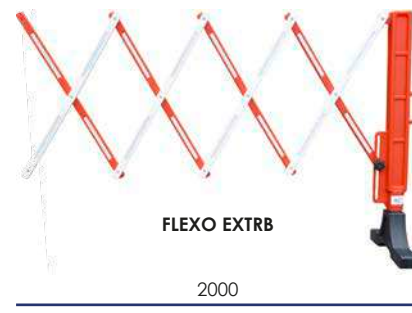
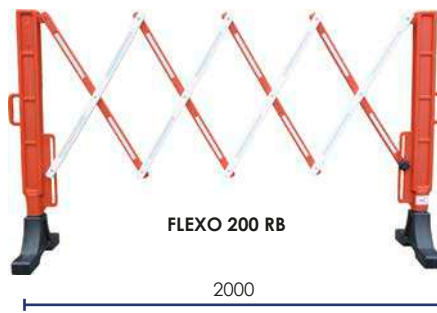
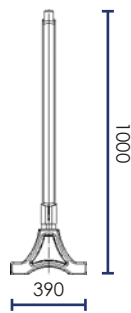

EXTENSO ◀▶ 2,40 m

Code		
EXTENSO		7,50
EXTENSO JA		7,50

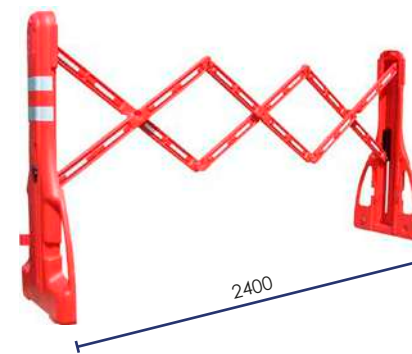
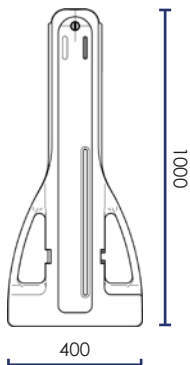
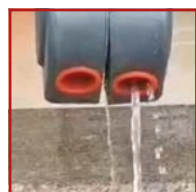

OPTION ◦ OPTIONAL ◦ OPCIÓN ◦ OPTIONAL



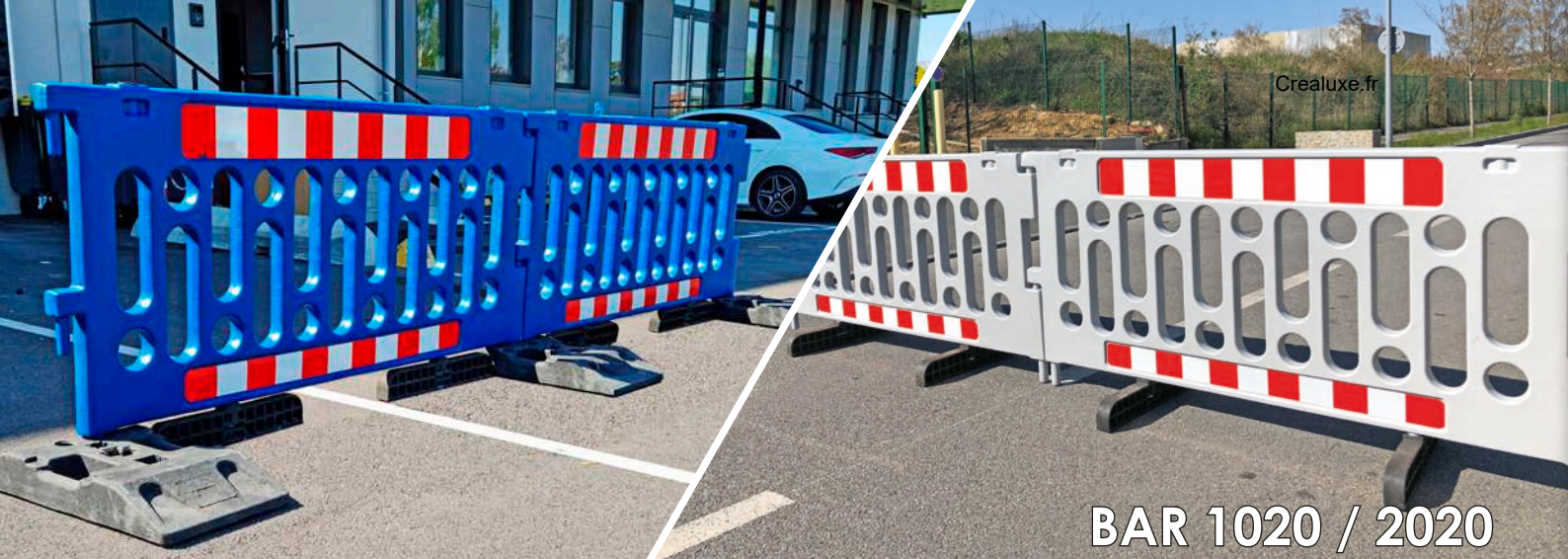

BAR 1020 / 2020

BARRIÈRES POLYPROPYLENE POLYPROPYLENE BARRIERS BARRERAS DE POLIPROPILENO ◦ SPERRGITTER

Classe 1 ◦ Class 1
Clase 1 ◦ Klasse 1

 Autres couleurs : mini 50
Others colors : mini 50
Otros colores : mini 50
Andere Farben : Mini 50



Code	
BAR 2020 GR	RAL 7035
BAR 2020 OR	RAL 2004



Pieds intégrés
With heavy feet
Pies integrados
Integrierte Füße

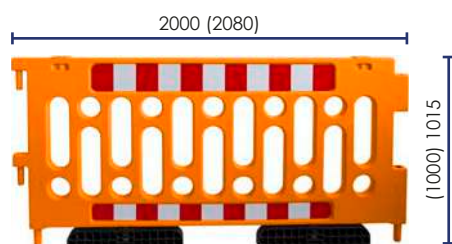
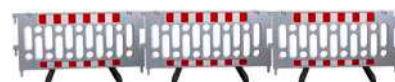

BAR 2020 OR

Code	
BAR 2020 GR SP	RAL 7035
BAR 2020 OR SP	RAL 2004



Pour base
For base
Para base
Für sockel

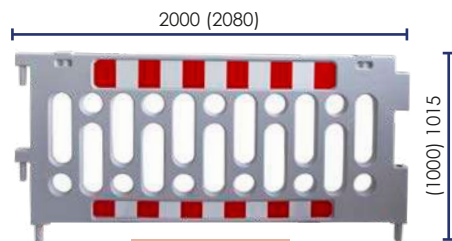

BAR 2020 GR SP

Code	
BAR 1020 GR	RAL 7035
BAR 1020 OR	RAL 2004



Pour base
For base
Para base
Für sockel

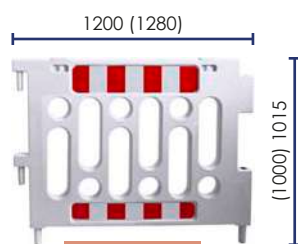

BAR 1020 GR

OPTION ◦ OPTIONAL ◦ OPCIÓN ◦ OPTIONAL

BASE 2500

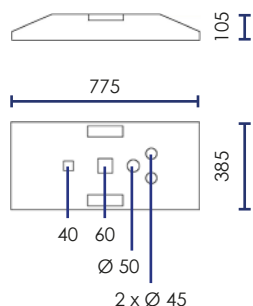

BASE 310

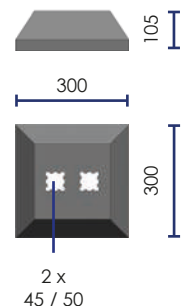

Poignée intégrée
Built in handle
Mango incorporado
Handgriff

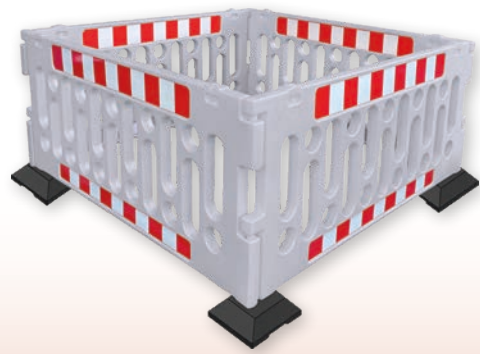

1200 X 1200

BAR 104 OR



BAR 134 OR



BAR 104 GR

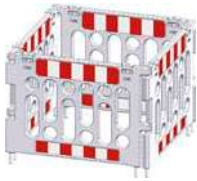

BAR 134 GR



2000 X 2000

BAR 204 OR



BAR 234 OR



BAR 244 OR



BAR 204 GR



BAR 234 GR



BAR 244 GR



OPTION ◦ OPTIONAL ◦ OPCIÓN ◦ OPTIONAL

Ø 180

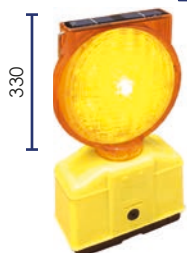

LAMP SOL



360°



3 modes d'éclairage
3 light modes
3 modos de iluminación
3 Positionen



x 2
BARTAPE 2
Classe 2



RSNA

CHAINE

RUBAN DE SIGNALISATION

WARNING TAPE ◦ CINTA DE SEÑALIZACIÓN ◦ ABSPERRBÄNDER



IMPRESSION 1 FACE ◦ 1 SIDE PRINTING ◦ IMPRESIÓN A 1 CARA ◦ 1-SEITIG BEDRUCKEN

Code	
RSNA 01 RB	x 36
RSNA 121 RB	x 12
RSNA 01 NJ	x 36
RSNA 121 NJ	x 12
RSNA 01 VE	x 36
RSNA 121 VE	x 12

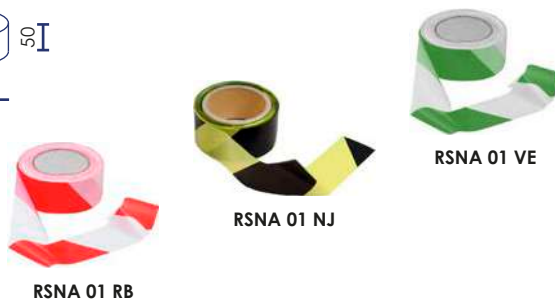
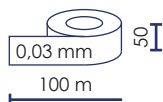

IMPRESSION 2 FACES ◦ 2 SIDES PRINTING ◦ IMPRESIÓN A 2 CARAS ◦ 2-SEITIG BEDRUCKEN

Code	
RSNA 02 RB	x 36

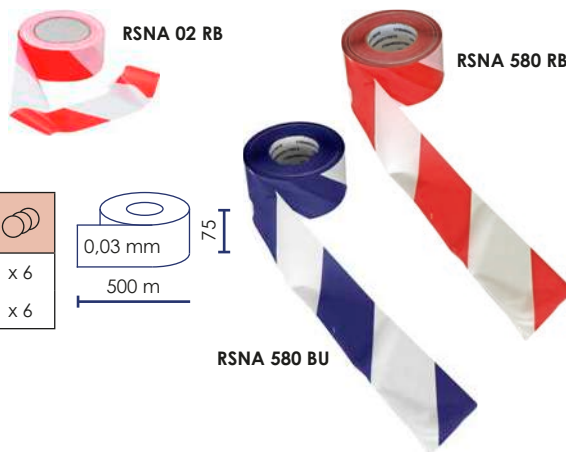
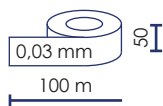

Code	
RSNA 580 RB	x 6
RSNA 580 BU	x 6

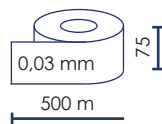

ACCESSOIRES ◦ ACCESSORIES
ACCESORIOS ◦ ZUBEHÖR

PFER 520 SB



SP 1205 SB

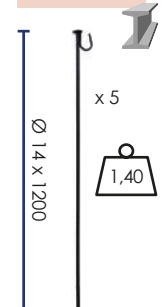

CHAINE POLYPRO ET ACCESSOIRES

POLYPROPYLENE CHAIN ◦ CADENA DE PLÁSTICO ◦ KUNSTSTOFFKETTEN



Code	
CFLUO 825 SBS	○
CNJ 801 SBS	●
CBR 801 SBS	◐
CPB 801 SBS	○
CPR 801 SBS*	●
CBV 801 SBS	◐
CBB 801 SBS	◑
CPN 801 SBS	●

25 m - Ø 8



CFLUO 825 SBS



Accessoires ▶ p. 175
Accessories ▶ p. 175
Accesorios ▶ p. 175
Zubehör ▶ p. 175

* Epuisement stock ◦ While stock lasts ◦ Hasta agotar existencias ◦ Lagerverrat Begrenzung



GUI 200

GUI 500

BANDEAU DE SIGNALISATION TISSU ○ HIGH VISIBILITY WARNING STRIP
BANDA DE ADVERTENCIA ALTA VISIBILIDAD ○ **BAND MIT HOHER SICHTBARKEIT**



5 M



Bandes lestées
 Weighted bottom
 Bandas lastradas
 unten des Bands gewichtet

GUI 500 OR

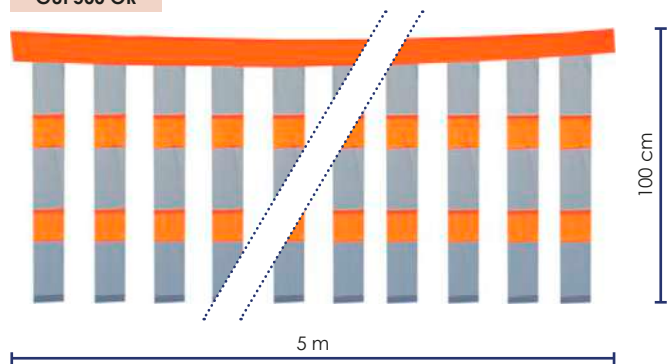

20 M



Bandes réfléchissantes
 Reflective tapes
 Tiras reflectantes
 Reflektierende Streifen



GUI 200 OR

CLASSE 1

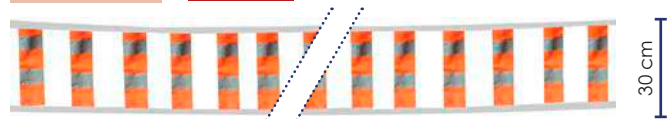

GUI 200 RB

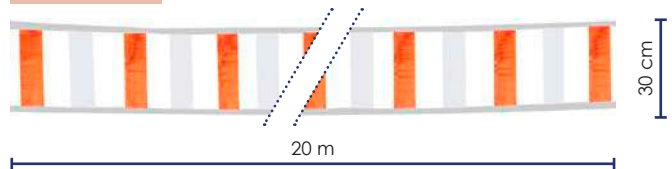

INCLUS ○ INCLUDED ○ INCLUIDO ○ INKLUSIVE



Sac de rangement
 Storage bag
 Bolsa de almacenamiento
 Aufbewahrungstasche

OPTION ○ OPTIONAL ○ OPCIÓN ○ OPTIONAL

ENR 200 ROUTE
 87 x 28 cm

ROUTE BARREE

ENR 200 ACCES
 87 x 28 cm

ACCES INTERDIT

ENR 200 SI
 29 x 27 cm





ENR 200

BARRIÈRE AVEC ENROULEUR ◦ **EXPANDABLE / RETRACTABLE BARRIER**
BARRERA DE SEÑALIZACIÓN CON ENROLLADOR ◦ **EINZIEHBARE ABSPERROLLE**

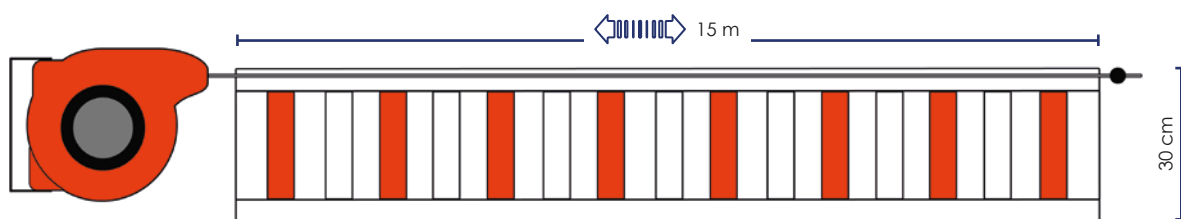

390 x 120 x 270  4.0



ENR 200 OR
 Réflechissant
 Reflective
 Reflektivo
 Reflektierend

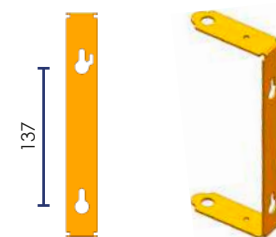

ENR 200 RB



ENR 200 NJ

INCLUS ◦ **INCLUDED**
INCLUIDO ◦ **INKLUSIVE**



OPTION ◦ **OPTIONAL** ◦ **OPCIÓN** ◦ **OPTIONAL**

ENR 200 ROUTE
 87 x 28 cm

ROUTE BARREE

ENR 200 ACCES
 87 x 28 cm

ACCES INTERDIT

ENR 200 SI
 29 x 27 cm





ENR 200

OPTIONS ○ **OPTIONS** ○ **OPCIONES** ○ **OPTIONEN**

ENR BOX

500 x 200 x H 480



Porte coulissante
Sliding door
Puerta corrediza
Schiebetürsystem



ENR POST 140



Poteau support et récepteur
Fixing post and receiver
Poste soporte y receptor
Doppelte Funktion: Träger und Empfänger

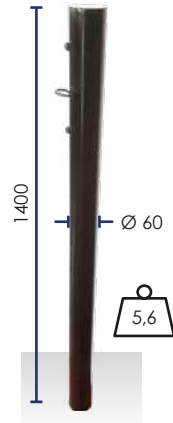

BASE 2500

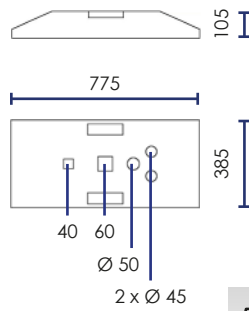

ENR 200 + BBASE

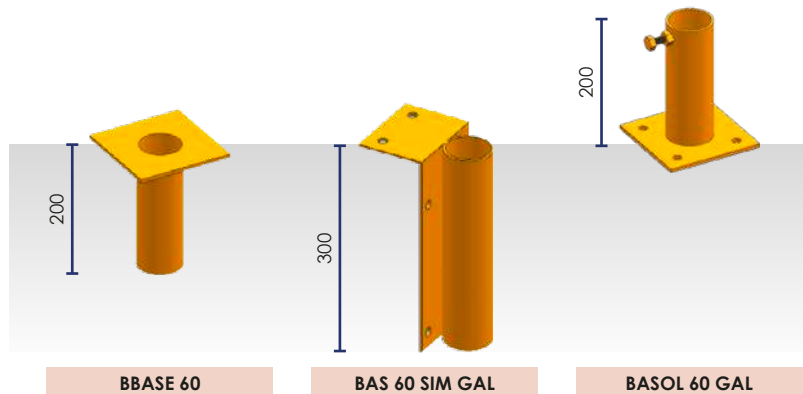

BBASE 60

BAS 60 SIM GAL

BASOL 60 GAL



LAMPES ◦ SAFETY LAMPS ◦ LUZ DE SEÑALIZACIÓN ◦ SIGNALISIERUNG

LAMPSOL 180

360°

Ø 180

330

3 modes d'éclairage
3 light modes
3 modos de iluminación
3 Positionen

ON / OFF

LAMPSOL

360°

Ø 180

330

3 modes d'éclairage
3 light modes
3 modos de iluminación
3 Positionen

FLASH 90

360°

Ø 80

160

Ø 35

ON / OFF

FLASH 101OR

111 x 104 x 35

1500 m

360°

IP67

Lithium

+ 50 °C
- 20 °C

ON / OFF

FLASH 101OR x 1

FLASH 106OR x 6

70

350

370

9 modes de clignotements ▶ fiche technique
9 flash modes ▶ data sheet
9 modos de destello ▶ ficha tecnica
9 Positionen ▶ datenblatt

60 H

FAR 001

200

Ø 95

VESTES DE SÉCURITÉ ◦ SAFETY VEST ◦ CHALECO DE SEGURIDAD ◦ SICHERHEITSJACKE

ISO 20471 ◦ Taille unique XL ◦ XL size ◦ Talla XL ◦ Einzelne Größe XL







**PARAVENT
/ BARRIÈRE DE PROTECTION**

- Auto portante
- 2 hauteurs : 1 m ou 1,80 m
- En 3 vantaux
- Inox ou PVC
- Repliable
- Tissus à assembler sur l'armature par le client
- Tissu imprimé 1 face.
- Panneaux décoratifs avec velcro :
 - ▷ Facile à mettre en place
 - ▷ Facile à tendre
 - ▷ Tissus lavables

**SCREEN
/ PROTECTION BARRIER**

- Self Standing
- 2 heights: 1 m or 1.80 m
- In 3 panels
- Stainless steel or PVC
- Foldable
- Fabrics to be mounted on the frame by the customer
- 1 side printed fabric
- Decorative panels with velcro :
 - ▷ Easy to put in place
 - ▷ Easy to stretch
 - ▷ Washable fabrics

**BIOMBO
/ BARRERA DE SEÑALIZACIÓN**

- Estructura autoportante
- 2 alturas: 1 m o 1,80 m
- De 3 paneles
- Acero inoxidable o PVC
- Plegable
- Armados de los tejidos en el marco por el cliente
- Tejido impreso a 1 cara
- Paneles decorativos con velcro:
 - ▷ Fácil de colocar
 - ▷ Fácil de tender
 - ▷ Tejidos lavables

**SCHUTZ BARRIERE
/ SICHTSCHUTZ**

- Freistehend
- Höhe : 1m oder 1,8m
- 3 Sicht- / Schutzfelder
- Ständer Ausführung in Stahl oder Kunststoff
- Faltbar
- Montage der Elemente vor Ort durch Kunden
- 1 Seite ist bedruckt.
- Bespannung mit Klettverschluss :
 - ▷ einfach zu montieren
 - ▷ ist dehnbar
 - ▷ waschbar

PERSONNALISATION ◦ **CUSTOMIZATION** ◦ **PERSONALIZACIÓN** ◦ **PERSONALISIERUNG**

TRAVO PRINT

Minimum 15 barrières (de 3 panneaux) ◦ Minimum order 15 barriers (3 panels)
 Pedido mínimo: 15 barreras (3 paneles)
 Mini Bestellungen 15 Absperrungen (3 Sicht- / Schutzfelder)

TYPE DE TISSU ◦ **FABRIC CHOICE**

TIPO DE TEJIDO ◦ **STOFFAUSWAHL**



IGNIFUGE

Tissu ignifugé, impression 3 couleurs
Flame retardant fabric, 3 colors printing
Tejido ignífugo, Impresión a 3 colores
Flammfestes Gewebe, 3 Farben-Druck



Tissu brise vent, impression 3 couleurs
Windproof fabric, 3 colors printing
Tejido cortaviento, Impresión a 3 colores
Winddichtes Gewebe, 3 Farben-Druck



Tissu standard, impression quadri
Standard fabric, 4 colors printing
Tejido estándar, Impresión a 4 colores
Standard Gewebe, 4 Farben-druck



COULEUR

COLOR ◦ **COLOR** ◦ **FARBEN**



Personnalisation
 Customization
 Personalización
 Personalisierung

Standard
 Standard
 Estándar
 Standard



FIXATION TISSU ◦ **FABRIC FIXATION**

FIJACIÓN DEL TEJIDO ◦ **GEWEBE BEFESTIGUNGS**



Velcro

Délai 5 semaines
 Lead-time 5 weeks
 Plazo de entrega : 5 semanas
 Frist 5 Wochen



Cousu, délai 10 semaines
Sewn, within 10 weeks
Cosido, plazo de 10 semanas
Genäht, Frist 10 Wochen



OPTION
OPTIONAL
OPCIÓN
OPTIONAL



TRAVOBAG 100



TRAVOFEET 128

Pour
 For
 Para
 Für
 TRAVO 128 / 228



TRAVOBASE

Pour
 For
 Para
 Für
 TRAVO 100 / 180



TRAVO 100

VERSION CLASSIQUE ◦ CLASSIC VERSION ◦ VERSIÓN CLÁSICA ◦ KLASSISCHE VERSION

- **Structure PVC** (4.2 kg - H 1 m)
 - ▷ Légère, maniable et facilement transportable
 - ▷ Jonction en PVC pour maintenir les panneaux entre eux
 - ▷ Facile à déplier et replier
 - ▷ Utilisable en milieu humide
 - ▷ Ne craint pas la pluie
- **PVC structure** (4.2 kg - H 1 m)
 - ▷ Lightweight, easy to use and transport
 - ▷ PVC link to hold the panels together
 - ▷ Easy to unfold and fold
 - ▷ Can be used in a humid environment
 - ▷ Rain resistant
- **Estructura de PVC** (4.2 kg - H 1 m)
 - ▷ Ligero, fácil de usar y transportar
 - ▷ Enlace de PVC para unir los paneles
 - ▷ Fácil de desplegar y plegar
 - ▷ Puede usarse en un ambiente húmedo
 - ▷ Resistente a la lluvia
- **PVC- Material-Struktur** (Gewicht 4.2 kg - H 1 m)
 - ▷ Geringes Gewicht, handlich und leicht zu transportieren
 - ▷ Verbindungselemente aus Kunststoff
 - ▷ Leicht zu entfalten und zusammenlegen
 - ▷ In feuchter Umgebung verwendbar
 - ▷ Regen resistant



TRAVOLTE



TRAVO 100

BARRIÈRE D'INTERVENTION LÉGÈRE o PVC PROTECTION BARRIER BARRERA DE SEÑALIZACIÓN EN PVC o LEICHTE ABSPERRUNG

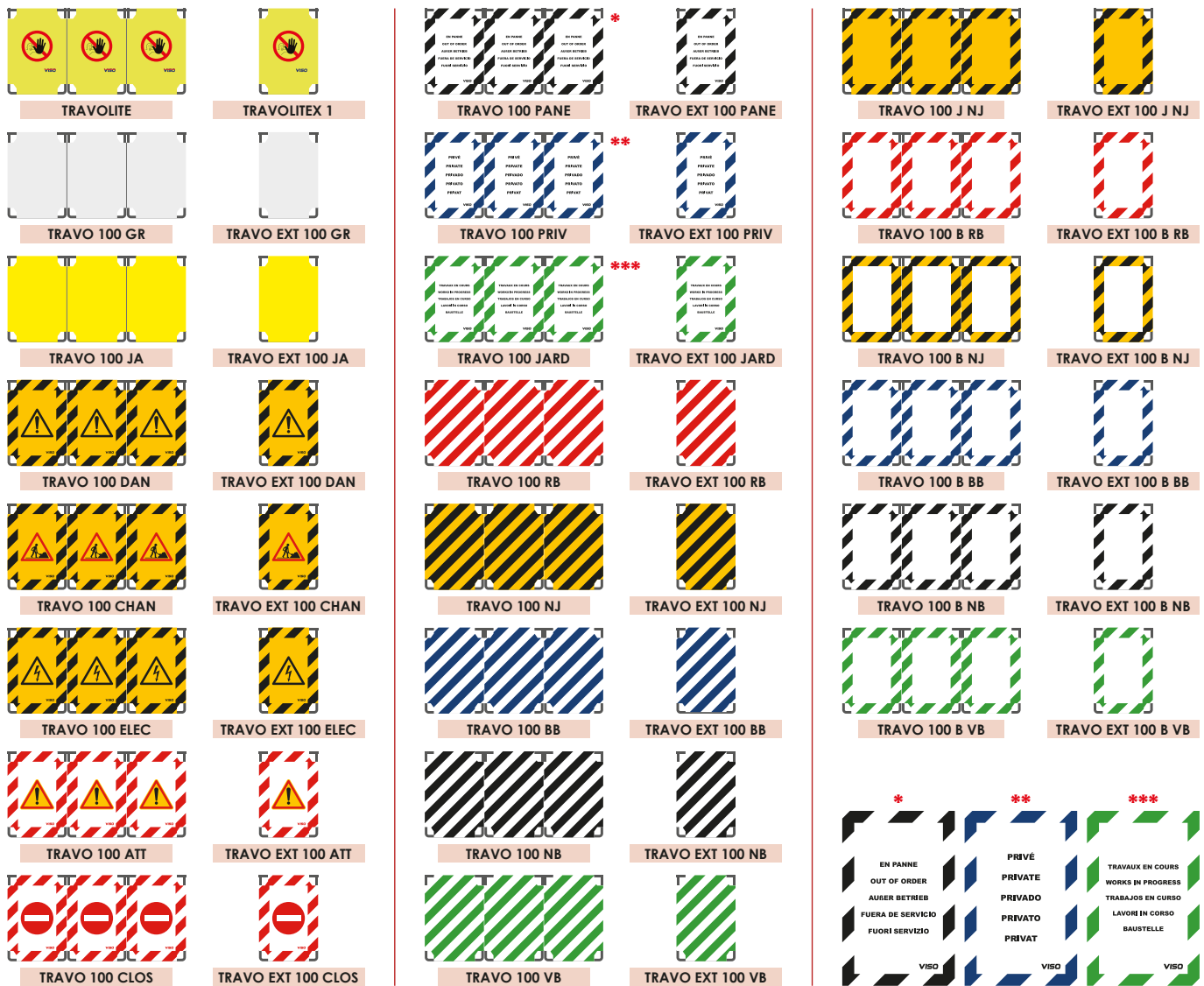

OPTION
OPTIONAL
OPCIÓN
OPTIONAL

TRAVOBAG 100



TRAVOBASE



TRAVO 128

VERSION DESIGN ◦ VERSIÓN DESIGN ◦ VERSIÓN DESIGN ◦ DESIGN VERSION

- **Structure Inox** (10,5 kg - H 1 m)
 - ▷ Charnières boulonnées pour maintenir les panneaux entre eux
 - ▷ Stabilité renforcée
 - ▷ Intérieur / Extérieur
 - ▷ Convient en milieu humide
 - ▷ Ne craint pas la pluie
- **Stainless steel structure** (10,5 kg - H 1 m)
 - ▷ Bolt-on hinges to hold panels together
 - ▷ Reinforced stability
 - ▷ Indoor / Outdoor
 - ▷ Can be used in a humid environment
 - ▷ Rain resistant
- **Posibilidad de fijación a largo plazo** gracias a la placa de fijación
- **Edelstahlkonstruktion** (Gewicht 10,5 kg - H 1 m)
 - ▷ Anschraubbare Scharniere zum Zusammenhalten der Paneele.
 - ▷ Verstärkte Stabilität
 - ▷ Anwendung: Innen / Außen
 - ▷ Geeignet in feuchter Umgebung
 - ▷ Regen resistent
- **Möglichkeit der Langzeitfixierung** mittels Boden-Platten





TRAVO 128

BARRIÈRE D'INTERVENTION INOX ◦ STAINLESS STEEL PROTECTION BARRIER BARRERA DE SEÑALIZACIÓN EN ACERO INOXIDABLE ◦ ABSPERRUNG AUS INOX

TRAVO EXT 128



0,57 m

TRAVO 128



1,70 m

1,00 m



TRAVOFEET 128 / Option ◦ Optional ◦ Opción ◦ Optional



TRAVO 128 INT



TRAVO EXT 128 INT



TRAVO 128 PANE



TRAVO EXT 128 PANE



TRAVO 128 J NJ



TRAVO EXT 128 J NJ

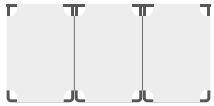

TRAVO 128 GR

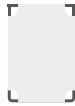

TRAVO EXT 128 GR



TRAVO 128 PRIV



TRAVO EXT 128 PRIV



TRAVO 128 B RB



TRAVO EXT 128 B RB

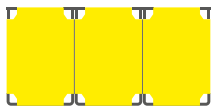

TRAVO 128 JA



TRAVO EXT 128 JA



TRAVO 128 JARD



TRAVO EXT 128 JARD



TRAVO 128 B NJ



TRAVO EXT 128 B NJ



TRAVO 128 DAN



TRAVO EXT 128 DAN



TRAVO 128 RB



TRAVO EXT 128 RB



TRAVO 128 B BB



TRAVO EXT 128 B BB



TRAVO 128 CHAN



TRAVO EXT 128 CHAN



TRAVO 128 NJ



TRAVO EXT 128 NJ



TRAVO 128 B NB



TRAVO EXT 128 B NB



TRAVO 128 ELEC



TRAVO EXT 128 ELEC



TRAVO 128 BB



TRAVO EXT 128 BB



TRAVO 128 B VB



TRAVO EXT 128 B VB



TRAVO 128 ATT



TRAVO EXT 128 ATT

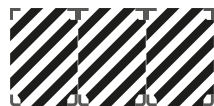

TRAVO 128 NB



TRAVO EXT 128 NB



TRAVO 128 B VV



TRAVO EXT 128 B VV



TRAVO 128 CLOS



TRAVO EXT 128 CLOS

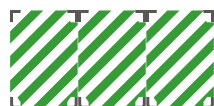

TRAVO 128 VB



TRAVO EXT 128 VB



TRAVO 128 B VV



TRAVO EXT 128 B VV

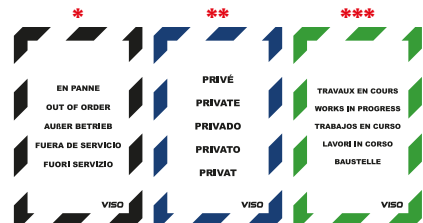

OPTION
OPTIONAL
OPCIÓN
OPTIONAL

TRAVOBAG 100



TRAVOFEET 128





TRAVO 180

VERSION CLASSIQUE ◦ CLASSIC VERSION ◦ VERSIÓN CLÁSICA ◦ KLASSISCHE VERSION

- **Structure PVC** (6,5 kg - H 1,80 m)
 - ▷ Légère, maniable et facilement transportable
 - ▷ Jonction en PVC pour maintenir les panneaux entre eux
 - ▷ Facile à déplier et replier
 - ▷ Utilisable en milieu humide
 - ▷ Ne craint pas la pluie
- **PVC structure** (6,5 kg - H 1,80 m)
 - ▷ Lightweight, easy to use and transport
 - ▷ PVC link to hold the panels together
 - ▷ Easy to unfold and fold
 - ▷ Can be used in a humid environment
 - ▷ Rain resistant
- **Estructura de PVC** (6,5 kg - H 1,80 m)
 - ▷ Ligero, fácil de usar y transportar
 - ▷ Enlace de PVC para unir los paneles
 - ▷ Fácil de desplegar y plegar
 - ▷ Puede usarse en un ambiente húmedo
 - ▷ Resistente a la lluvia
- **PVC- Material-Struktur** (Gewicht 6,5kg - H 1,80 m)
 - ▷ Geringes Gewicht, handlich und leicht zu transportieren
 - ▷ Verbindungselemente aus Kunststoff
 - ▷ Leicht zu entfalten und zusammenlegen
 - ▷ In feuchter Umgebung verwendbar
 - ▷ Regen resistant

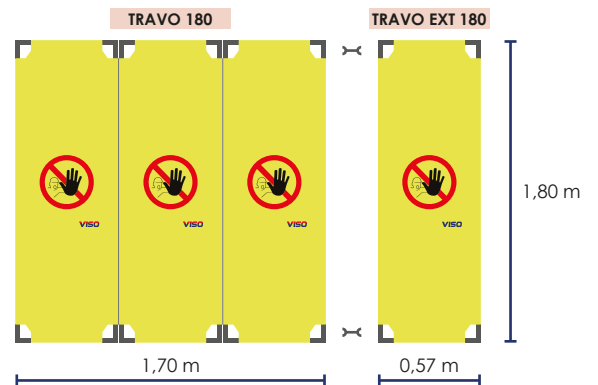

OPTION
OPTIONAL
OPCIÓN
OPTIONAL

TRAVOBAG 180





TRAVO 180

BARRIÈRE D'INTERVENTION LÈGÈRE ○ PVC PROTECTION BARRIER
 BARRERA DE SEÑALIZACIÓN EN PVC ○ LEICHTE ABSPERRUNG

		<td> <td> <td> </td></td></td>	<td> <td> </td></td>	<td> </td>	
TRAVO 180 INT	TRAVO EXT 180 INT	TRAVO 180 PANE	TRAVO EXT 180 PANE	TRAVO 180 J NJ	TRAVO EXT 180 J NJ
<td> <td> <td> <td> <td> </td></td></td></td></td>	<td> <td> <td> <td> </td></td></td></td>	<td> <td> <td> </td></td></td>	<td> <td> </td></td>	<td> </td>	
TRAVO 180 GR	TRAVO EXT 180 GR	TRAVO 180 PRIV	TRAVO EXT 180 PRIV	TRAVO 180 B RB	TRAVO EXT 180 B RB
<td> <td> <td> <td> <td> </td></td></td></td></td>	<td> <td> <td> <td> </td></td></td></td>	<td> <td> <td> </td></td></td>	<td> <td> </td></td>	<td> </td>	
TRAVO 180 JA	TRAVO EXT 180 JA	TRAVO 180 JARD	TRAVO EXT 180 JARD	TRAVO 180 B NJ	TRAVO EXT 180 B NJ
<td> <td> <td> <td> <td> </td></td></td></td></td>	<td> <td> <td> <td> </td></td></td></td>	<td> <td> <td> </td></td></td>	<td> <td> </td></td>	<td> </td>	
TRAVO 180 DAN	TRAVO EXT 180 DAN	TRAVO 180 RB	TRAVO EXT 180 RB	TRAVO 180 B BB	TRAVO EXT 180 B BB
<td> <td> <td> <td> <td> </td></td></td></td></td>	<td> <td> <td> <td> </td></td></td></td>	<td> <td> <td> </td></td></td>	<td> <td> </td></td>	<td> </td>	
TRAVO 180 CHAN	TRAVO EXT 180 CHAN	TRAVO 180 NJ	TRAVO EXT 180 NJ	TRAVO 180 B NB	TRAVO EXT 180 B NB
<td> <td> <td> <td> <td> </td></td></td></td></td>	<td> <td> <td> <td> </td></td></td></td>	<td> <td> <td> </td></td></td>	<td> <td> </td></td>	<td> </td>	
TRAVO 180 ELEC	TRAVO EXT 180 ELEC	TRAVO 180 BB	TRAVO EXT 180 BB	TRAVO 180 B VB	TRAVO EXT 180 B VB
<td> <td> <td> <td> <td> </td></td></td></td></td>	<td> <td> <td> <td> </td></td></td></td>	<td> <td> <td> </td></td></td>	<td> <td> </td></td>	<td> </td>	
TRAVO 180 ATT	TRAVO EXT 180 ATT	TRAVO 180 NB	TRAVO EXT 180 NB	TRAVO 180 B VB	TRAVO EXT 180 B VB
<td> <td> <td> <td> <td> </td></td></td></td></td>	<td> <td> <td> <td> </td></td></td></td>	<td> <td> <td> </td></td></td>	<td> <td> </td></td>	<td> </td>	
TRAVO 180 CLOS	TRAVO EXT 180 CLOS	TRAVO 180 VB	TRAVO EXT 180 VB	TRAVO 180 B VB	TRAVO EXT 180 B VB



TRAVO 228

VERSION DESIGN ◦ VERSIÓN DESIGN ◦ VERSIÓN DESIGN ◦ DESIGN VERSION

- **Structure Inox** (18 kg - H 1,80 m)
 - ▷ Charnières boulonnées pour maintenir les panneaux entre eux
 - ▷ Stabilité renforcée
 - ▷ Intérieur / Extérieur
 - ▷ Convient en milieu humide
 - ▷ Ne craint pas la pluie
- **Stainless steel structure** (18 kg - H 1,80 m)
 - ▷ Bolt-on hinges to hold panels together
 - ▷ Reinforced stability
 - ▷ Indoor / Outdoor
 - ▷ Can be used in a humid environment
 - ▷ Rain resistant
- **Estructura de acero inoxidable** (18 kg - H 1,80 m)
 - ▷ Bisagras atornilladas para unir los paneles
 - ▷ Estabilidad reforzada
 - ▷ Interior / Exterior
 - ▷ Puede usarse en un ambiente húmedo
 - ▷ Resistente a la lluvia
- **Edelstahlkonstruktion** (Gewicht 18 kg - H 1,80 m)
 - ▷ Anschraubbare Scharniere zum Zusammenhalten der Paneele.
 - ▷ Verstärkte Stabilität
 - ▷ Anwendung: Innen / Außen
 - ▷ Geeignet in feuchter Umgebung
 - ▷ Regen resistent
- **Möglichkeit der Langzeitfixierung** mittels Boden-Platten

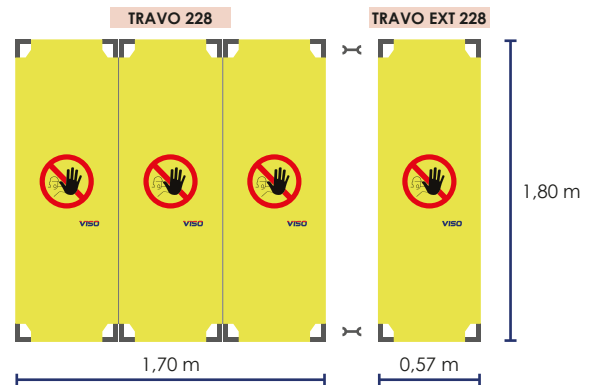



TRAVO 228

BARRIÈRE D'INTERVENTION INOX ◦ STAINLESS STEEL PROTECTION BARRIER
 BARRERA DE SEÑALIZACIÓN EN ACERO INOXIDABLE ◦ **ABSPERRUNG AUS INOX**

TRAVO 228 INT	TRAVO EXT 228 INT	TRAVO 228 PANE	TRAVO EXT 228 PANE	TRAVO 228 J NJ	TRAVO EXT 228 J NJ
TRAVO 228 GR	TRAVO EXT 228 GR	TRAVO 228 PRIV	TRAVO EXT 228 PRIV	TRAVO 228 B RB	TRAVO EXT 228 B RB
TRAVO 228 JA	TRAVO EXT 228 JA	TRAVO 228 JARD	TRAVO EXT 228 JARD	TRAVO 228 B NJ	TRAVO EXT 228 B NJ
TRAVO 228 DAN	TRAVO EXT 228 DAN	TRAVO 228 RB	TRAVO EXT 228 RB	TRAVO 228 B BB	TRAVO EXT 228 B BB
TRAVO 228 CHAN	TRAVO EXT 228 CHAN	TRAVO 228 NJ	TRAVO EXT 228 NJ	TRAVO 228 B NB	TRAVO EXT 228 B NB
TRAVO 228 ELEC	TRAVO EXT 228ELEC	TRAVO 228 BB	TRAVO EXT 228 BB	TRAVO 228 B VB	TRAVO EXT 228 B VB
TRAVO 228 ATT	TRAVO EXT 228 ATT	TRAVO 228 NB	TRAVO EXT 228 NB		
TRAVO 228 CLOS	TRAVO EXT 228 CLOS	TRAVO 228 VB	TRAVO EXT 228 VB		

Créaluxe.fr

Crealuxe SARL
BP 4003584101 Orange
CEDEX
04 86 71 54 42
serviceclient@crealuxe.fr

