



## Balisage ◦ Safety marking





**PLASTIQUE** ◦ PLASTIC ◦ PLÁSTICO ◦ KUNSTSTOFF

**POTEAUX ET BASES** ◦ POSTS AND BASES ◦ POSTES Y BASES ◦ PFOSTEN UND BASEN

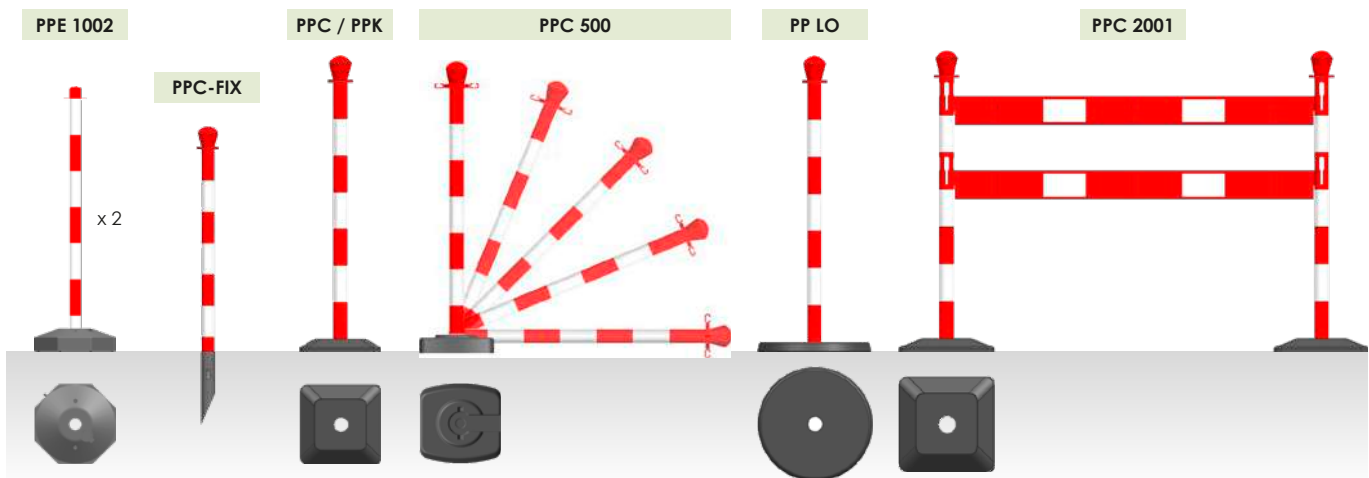

**ACCESSOIRES** ◦ ACCESSORIES ◦ ACCESORIOS ◦ ZUBEHÖR

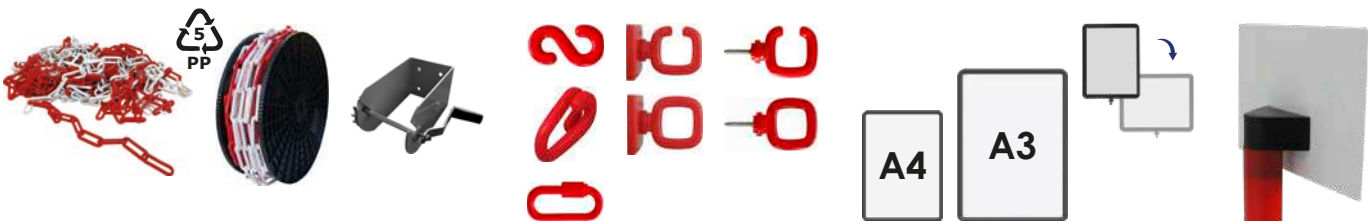

**BALISE HAUTE VISIBILITÉ** ◦ HIGH VISIBILITY BOLLARD  
BALIZA ALTA VISIBILIDAD ◦ PFOSTEN MIT HOHER SICHTBARKEIT





# POTEAU DE BALISAGE PREMIUM

SIGN POST ◦ POSTE DE BALIZAMIENTO  
KETTENSTÄNDER KUNSTSTOFF

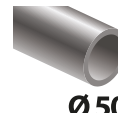

Code	
PPC 40 RB	
PPC 40 NJ	
PPC 40 BU	
PPC 40 VE	
PPK 40 RB	
PPK 40 NJ	
PPK 40 BU	
PPK 40 VE	

**5,0**

**1,0**

+ = 3 kg

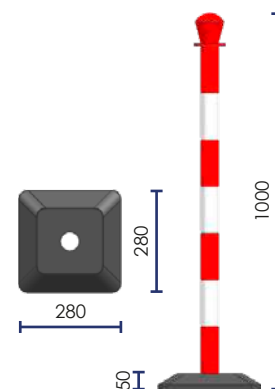

Code	
PPC 1001 RB	
PPC 1001 NJ	
PPC 1001 B	
PPC 1001 G	
PPC 1001 N	
PPC 3001 RB	
PPC 3001 NJ	
PPC 3001 B	
PPC 3001 G	
PPC 3001 N	

**5,2**

**1,2**

+ = 3 kg

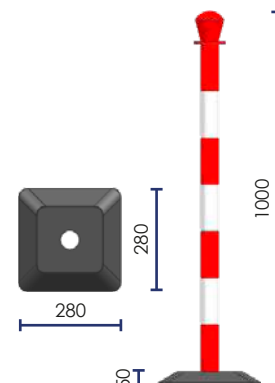

\* Base lestée ◦ Loaded base ◦ Base lastrada ◦ Beschwertem Standfuß

Base vide ◦ Empty base ◦ Base vacía ◦ Leerer Standfuß + = 3 kg

OPTION\* ◦ OPTIONAL ◦ OPCIÓN ◦ OPTIONAL \* ▶ p. 175

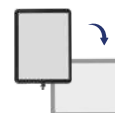
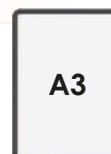
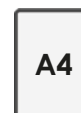

# KIT POTEAUX CHAINE

POST & CHAIN KIT ◦ KIT DE POSTES CON CADENA  
KETTENSTÄNDER SATZ

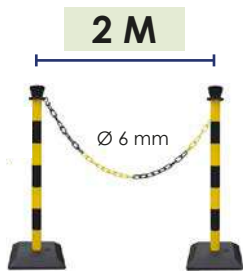
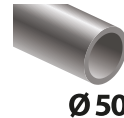

Code
CBR SET RB
CBR SET NJ
CBR SET BB
CBR SET NN
CBR SET GB
PPC 3002 RB
PPC 3002 NJ
PPC 3002 BB
PPC 3002 NN
PPC 3002 GB

10,6

Code
PPC SET 40 RB
PPC SET 40 NJ
PPC SET 40 VB
PPC SET 40 BB
PPK SET 40 RB
PPK SET 40 NJ
PPK SET 40 VB
PPK SET 40 BB

10,2

2,6

2,2

+ = 3 kg

+ = 3 kg

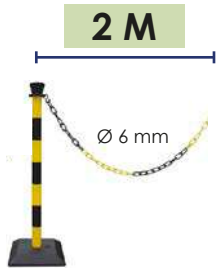

Code
CBR EXT RB
CBR EXT NJ
CBR EXT BB
CBR EXT NN
CBR EXT GB
PPC 3 EXT RB
PPC 3 EXT NJ
PPC 3 EXT BB
PPC 3 EXT NN
PPC 3 EXT GB

5,4

Code
PPC EXT RB
PPC EXT 40 NJ
PPC EXT 40 VB
PPC EXT 40 BB
PPK EXT RB
PPK EXT NJ
PPK EXT 40 VB
PPK EXT 40 BB

5,2

1,4

1,2

+ = 3 kg

+ = 3 kg

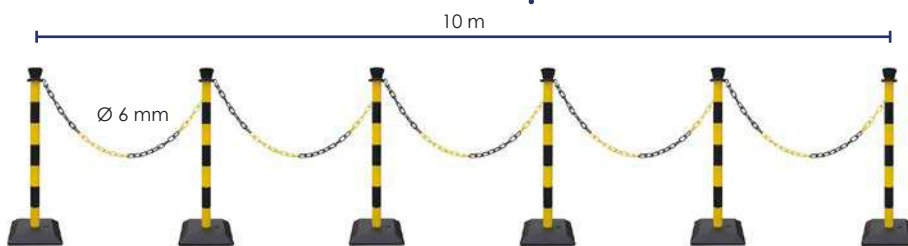

Code
CBR 6 SET
CBR 6 SET NJ
CBR 6 SET BB
CBR 6 SET NN
CBR 6 SET GB
PPC 3006 RB
PPC 3006 NJ
PPC 3006 BB
PPC 3006 NN
PPC 3006 GB

31,7

Code
PPC SET 406 RB
PPC SET 406 NJ
PPC SET 406 VB
PPC SET 406 BB
PPK SET 406 RB
PPK SET 406 NJ
PPK SET 406 VB
PPK SET 406 BB

30,5

7,7

6,5

+ = 3 kg

+ = 3 kg

\* Base lestée ◦ Loaded base  
Base lastrada ◦ Beschwertern Standfuß

Base vide ◦ Empty base ◦ Base vacía ◦ Leerer Standfuß + = 3 kg

\*\* Chaine blanche ◦ White chain ◦ Cadena blanca ◦ Kettenfarbe weiß



# PPC-FIX

## POTEAU DE BALISAGE ◦ SIGNPOST POSTE DE BALIZAMIENTO ◦ KETTENSTÄNDER

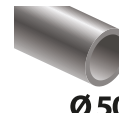

ABS

Ø 50

### À PLANTER ◦ WITH STAKE ◦ CON ESTACA ◦ VERSION : BODENBEFESTIGUNG

Code	
PPC-FIX RB	
PPC-FIX VB *	
PPC-FIX BB *	
PPC-FIX NJ	
PPC-FIX B	
PPC-FIX G	
PPC-FIX N	

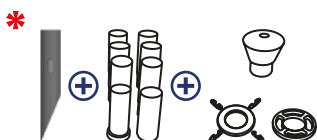
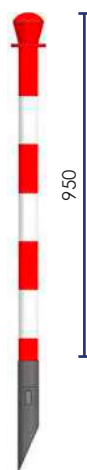
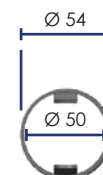
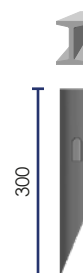
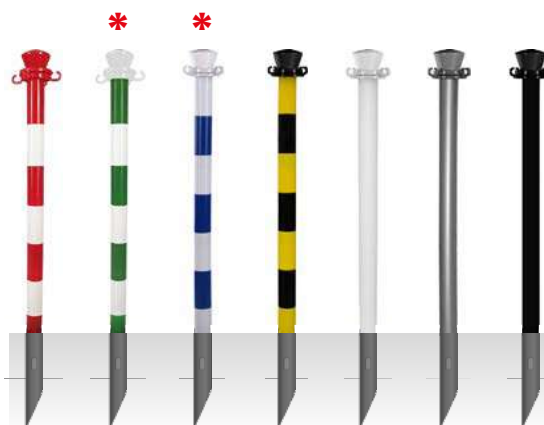

### BASE LOURDE ◦ HEAVY BASE ◦ BASE PESADA ◦ VERSION : STANDFUSS

Code	
PPLO 100 RB	
PPLO 100 NJ	
PPLO 100 B	
PPLO 100 G	
PPLO 100 N	
PPVD 100 RB	
PPVD 100 NJ	
PPVD 100 B	
PPVD 100 G	
PPVD 100 N	



+ 4 kg

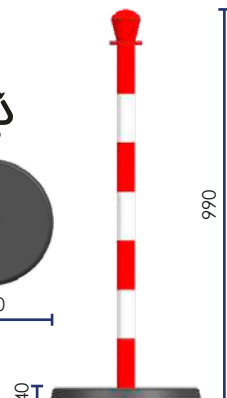
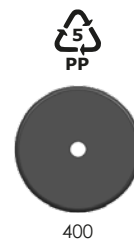

\* Base lestée ◦ Loaded base  
Base lastrada ◦ Beschwertem Standfuß

\* Base vide ◦ Empty base ◦ Base vacía ◦ Leerer Standfuß + 4 kg

OPTION\* ◦ OPTIONAL ◦ OPCIÓN ◦ OPTIONAL \* ▶ p. 175

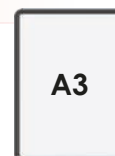



PPC 2001

**POTEAU DE BALISAGE PLIANT**  
**FOLDABLE SIGNPOST** ◦ **POSTE DE BALIZAMIENTO PLEGABLE**  
**VERSION : ZUSAMMENLEGBAR**

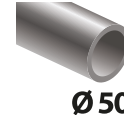

Code	
PPC 500 LOVB *	
PPC 500 LOBB *	
PPC 500 LOG	
PPC 500 LOB	
PPC 500 LONJ	
PPC 500 LON	
PPC 500 LORB	
PPC 500 VB *	
PPC 500 BB *	
PPC 500 G	
PPC 500 B	
PPC 500 NJ	
PPC 500 N	
PPC 500 RB	

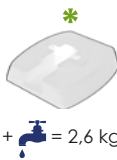
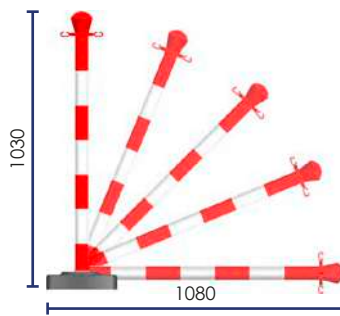

+ = 2,6 kg

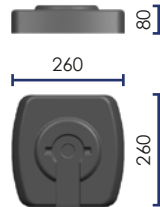
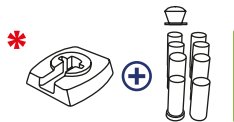

\* Base lestée ◦ Loaded base  
 Base lastrada ◦ Beschwertem Standfuß

Base vide ◦ Empty base ◦ Base vacía ◦ Leerer Standfuß + = 2,6 kg

**BARRICADE** ◦ **BARRIERS** ◦ **BARRERAS** ◦ **ABSPERRUNG**

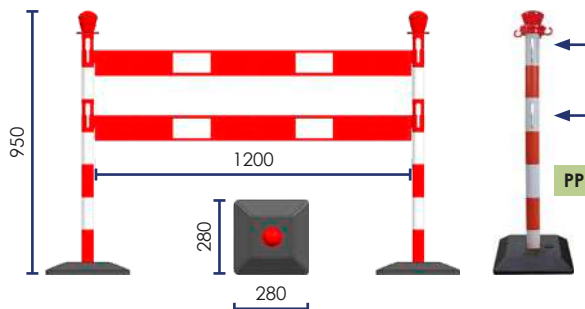
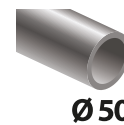
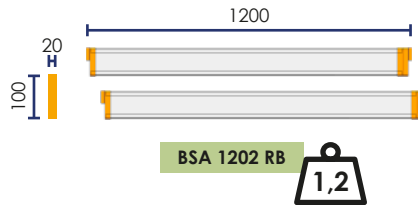



PPE



PPC A3 / A4

**POTEAU D'INFORMATION** ◦ INFORMATION POST  
**POSTE DE INFORMACIÓN** ◦ INFO-STÄNDER KUNSTSTOFF

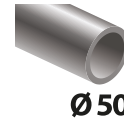

Code	
PPC A4 RB	
PPC A4 NJ	
PPC A4 B	
PPC A4 G	
PPC A4 N	
PPC A4 BB *	
PPC A4 VB *	

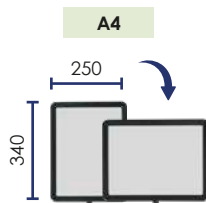

Base lestée  
 Loaded base  
 Base pesada  
 Beschwertem standfuß

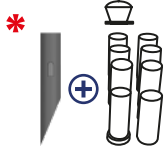
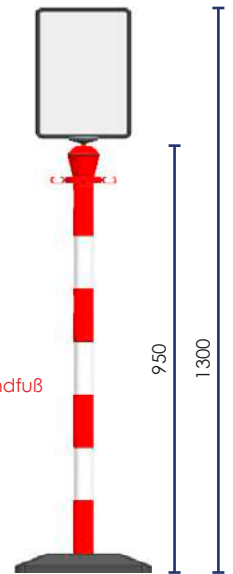
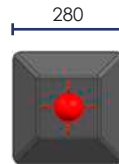

**POTEAU PLASTIQUE BUDGET**  
**BUDGET PLASTIC POST** ◦ **POSTE PLÁSTICO**  
**KETTENSTÄNDER KUNSTSTOFF**

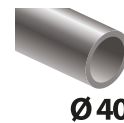

Code					kg
PPE 1002 RB		2	-	-	1,2
PPE 2100 RB		2	2 m	2	1,6
PPE 6100 RB		6	10 m	10	6,2

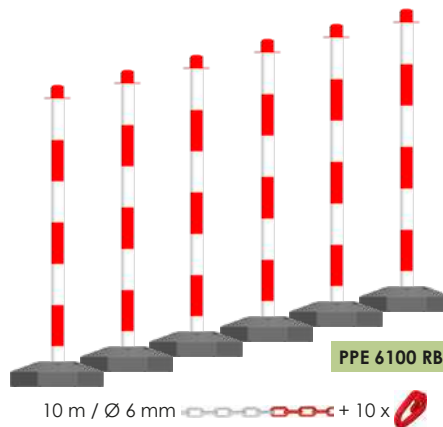
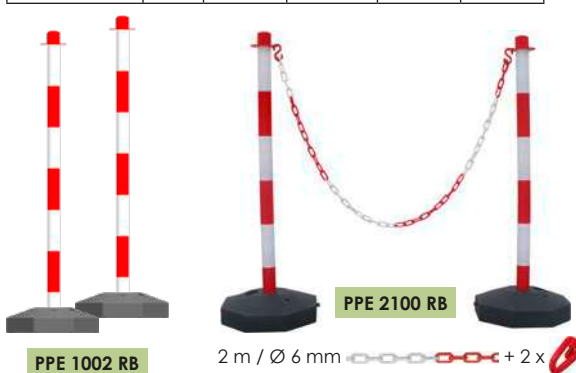
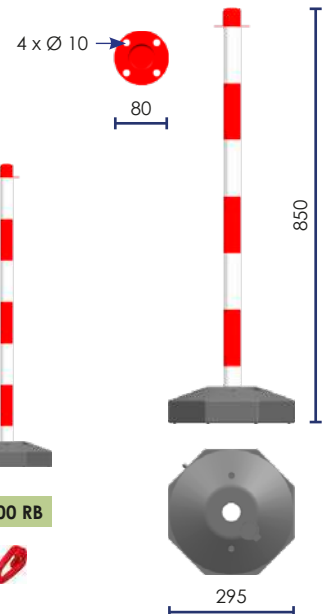





## ACCESSOIRES ◦ ACCESSORIES ◦ ACCESORIOS ◦ ZUBEHÖR



C FLUO 825 SBS



DVD 350 **4,5**

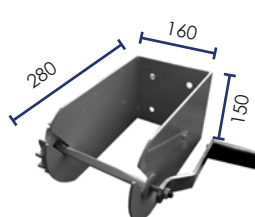

CMLRB 806 NB \*\*



Avec blocage  
Livré sans fixation  
With stop  
No fixation included  
Con bloqueo  
No incluye fijaciones  
Mit Blockierung  
Ohne Fixierung

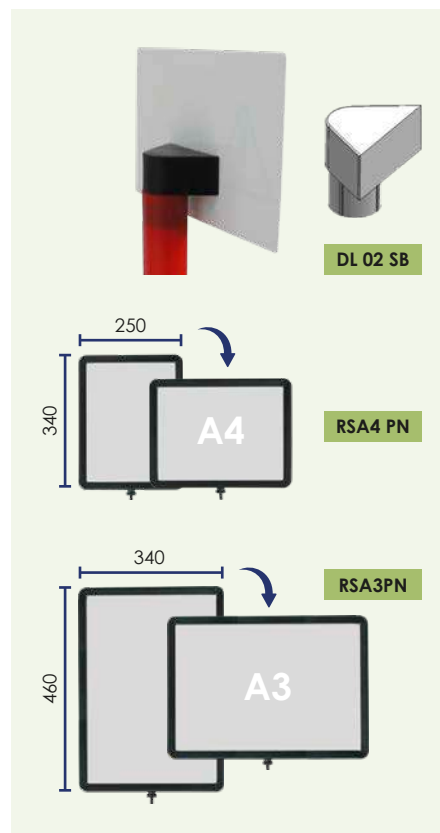

Code		∅	↔
CBR 625 NP		6	2
CBR 610 FAB			10
CBR 601 SBS			25
CNJ 625 FAB			2
CNJ 610 FAB			10
CNJ 601 SBS			25
CFLUO 825 SBS		8	25
CPB 820 NP			2
CPB 801 SBS			25
CPJ 801 SBS *			25
CNJ 820 NP			2
CNJ 801 SBS			25
CPN 820 FAB			2
CPN 801 SBS			25
CBR 820 NP			2
CBR 805 SB			5
CBR 810 SB		10	
CBR 801 SBS		25	
CMLRB 806 NB **		25	
CMLRB 825 SBS		25	
CPR 801 SBS *		25	
CBV 820 SB		2	
CBV 801 SBS		25	
CBB 820 SB		2	
CBB 801 SBS		25	
CBR 101 SBS		10	25
CNJ 101 SBS			25

Code		∅	
MRP 602 NP		6	1 ● + 1 ○
MRR 604 SB			x 4
MRN 604 SB			x 4
MRB 604 SB			x 4
MRP 802 NP		8	1 ● + 1 ○
MRB 804 SB			x 4
MRN 804 SB			x 4
MRR 804 SB			x 4
MRB 1004 SBS		10	x 4
MRN 1004 SBS			x 4
MRR 1004 SBS			x 4
APR 804 SB			x 4
APN 804 SB		x 4	
APB 804 SB		x 4	
EPR 804 SB		8	x 4
EPN 804 SB			x 4
EPB 804 SB			x 4
ERB 804 SB			2 ● + 2 ○

Code		∅	
CRO 004 SB			x 4
CNO 004 SB			
CBO 004 SB			
CRF 004 SB			x 4
CNF 004 SB			
CBF 004 SB			
APF 801 R SB			x 1
APF 801 N SB			
APF 801 B SB			
APO 801 R SB			x 1
APO 801 N SB			
APO 801 B SB			

\* Jusqu'à épuisement du stock ◦ While stock lasts ◦ Hasta agotar existencias ◦ Solange der Vorrat reicht



BAL 110

**BALISE HAUTE VISIBILITÉ** ○ HIGH VISIBILITY BOLLARD  
**BALIZA ALTA VISIBILIDAD** ○ PFOSTEN MIT HOHER SICHTBARKEIT



CAOUTCHOUC VULCANISÉ  
 VULCANIZED RUBBER  
 CAUCHO VULCANIZADO  
 VULKANISIERTEM KAUTSCHUK

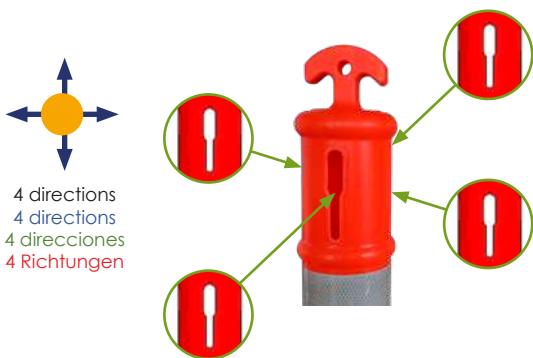
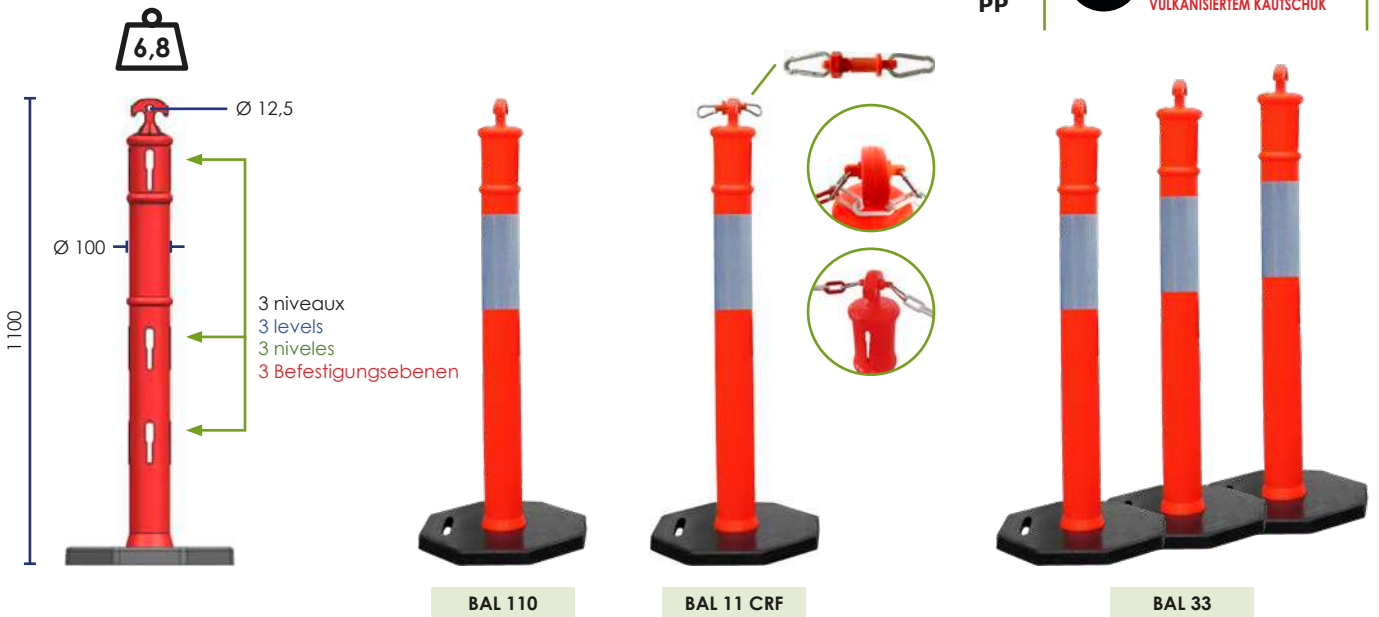

4 directions  
 4 directions  
 4 direcciones  
 4 Richtungen

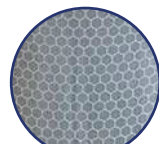

Classe 1 ○ Class 1  
 Klasse 1 ○ Klasse 1



Poignée  
 Handle  
 Asa  
 Handgriff



OPTION ○ OPTIONAL ○ OPCIÓN ○ OPTIONAL



RSNA 580 RB  
 80 mm x 500 m



RSNA 01 RB  
 50 mm x 100 m





**KIT CHAINE** ○ CHAIN KIT  
**KIT CON CADENA** ○ SET PFOSTEN MIT KETTEN



CAOUTCHOUC VULCANISÉ  
 VULCANIZED RUBBER  
 CAUCHO VULCANIZADO  
 VULKANISIERTEM KAUSCHUK

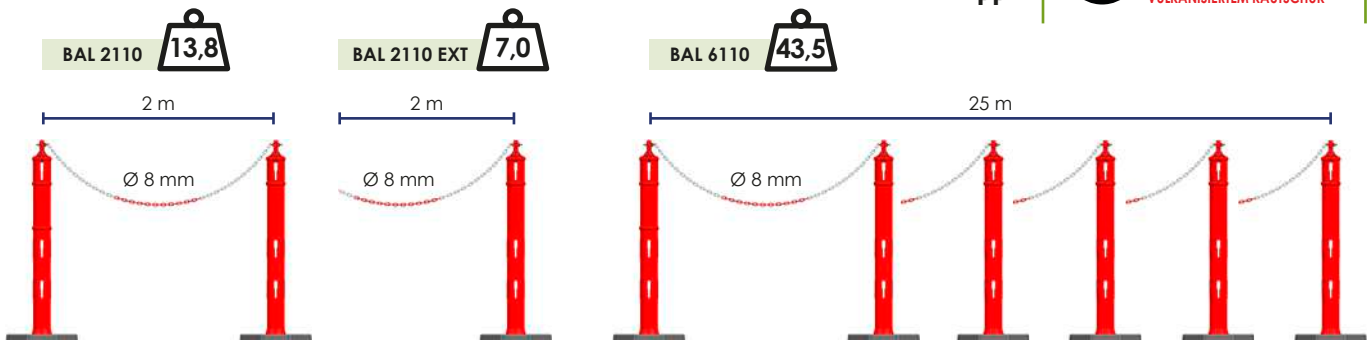

OPTION ○ OPTIONAL ○ OPCIÓN ○ OPTIONAL



- 25 m / Ø 6 mm CBR 601 SBS
- 25 m / Ø 8 mm CBR 801 SBS
- 25 m / Ø 10 mm CBR 101 SBS

CRF 210 SB



**KIT BARRE EXTENSIBLE** ○ EXPANDABLE BARRIER KIT  
**KIT BARRERA EXTENSIBLE**  
**SET ABSPERRPFOSTEN MIT ABSPERRSTANGEN**



CAOUTCHOUC VULCANISÉ  
 VULCANIZED RUBBER  
 CAUCHO VULCANIZADO  
 VULKANISIERTEM KAUSCHUK

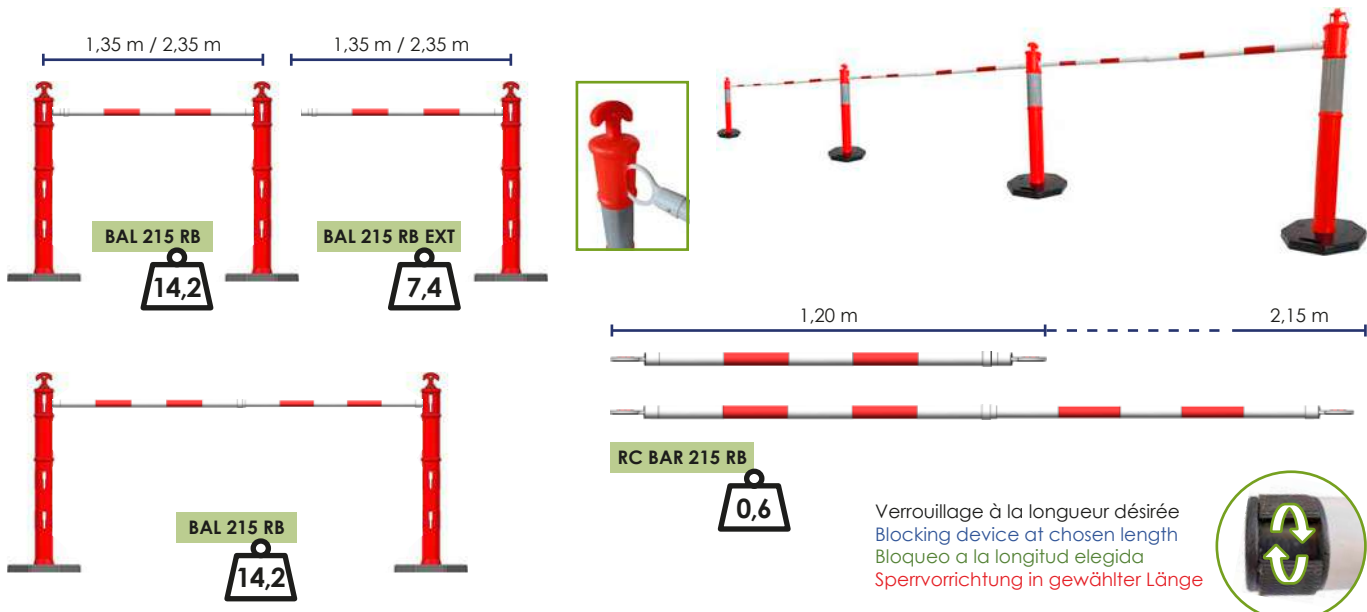

Verrouillage à la longueur désirée  
 Blocking device at chosen length  
 Bloqueo a la longitud elegida  
 Sperrvorrichtung in gewählter Länge





**KIT BARRIÈRE EXTENSIBLE** ○ **EXPANDABLE BARRIER KIT**  
**KIT CON BARRERAS EXTENSIBLES** ○ **SET ABSPERRPFOSTEN MIT LATTEN**



CAOUTCHOUC VULCANISÉ  
 VULCANIZED RUBBER  
 CAUCHO VULCANIZADO  
 VULKANISIERTEM KAUSCHUK

1,10 x 1,10 m ⇄ 1,90 x 1,90 m



BAL 4100 RB

36,7

1,10m ⇄ 1,90 m

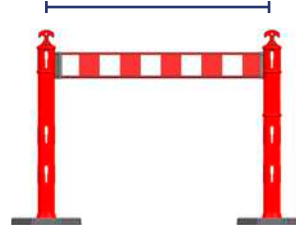

BAL 2201 RB

16,0

1,10m ⇄ 1,90 m

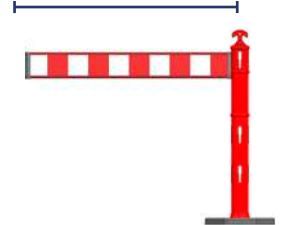

BAL 2201 RB EXT

9,2

2,20 m ⇄ 3,80 m



BAL 2201 RB

⊕ BAL 2201 RB EXT

1,10 x 1,10 m ⇄ 1,90 x 1,90 m

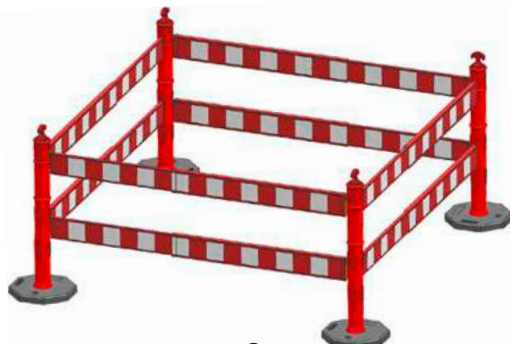

BAL 4200

46,1

1,10 m ⇄ 1,90 m

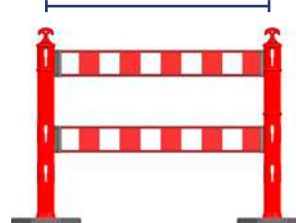

BAL 2202 RB

18,3

1,10 m ⇄ 1,90 m

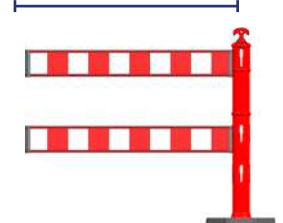

BAL 2202 RB EXT

11,5

2,20 m ⇄ 3,80 m



BAL 2202 RB

⊕ BAL 2202 RB EXT

BSA 2101 RB

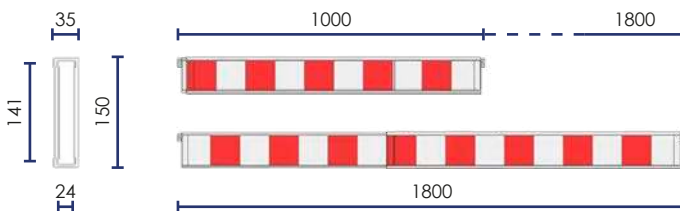



**KIT BÂCHE** ◦ **TARPAULIN KIT**  
**KIT CON LONA** ◦ **SET ABSPERPFOSTEN MIT PLANE**



**CAOUTCHOUC VULCANISÉ**  
**VULCANIZED RUBBER**  
**CAUCHO VULCANIZADO**  
**VULKANISIERTEM KAUSCHUK**



Toile PP enduit PVC  
 PVC coated polypropylene fabric  
 Lona de PP recubierta de PVC  
 PVC beschichtete Polyestergerewebe

Imprimé 1 face  
 1 side printed  
 Impreso a 1 cara  
 1 seite ist bedruckt

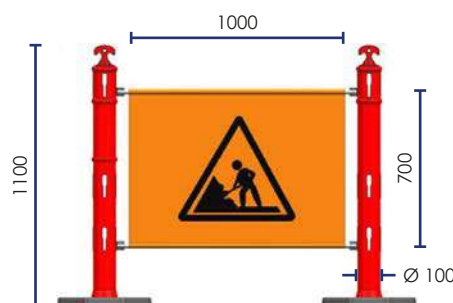

**BÂCHE PERSONNALISÉE** ◦ **CUSTOMIZED TARPAULIN**  
**LONA PERSONALIZADA** ◦ **KUNDENSPEZIFISCHE PLANEN**

Minimum 5 barrières ◦ Minimum order 5 barriers  
 Pedido mínimo: 5 barreras  
 Mini Bestellungen 5 Absperrungen

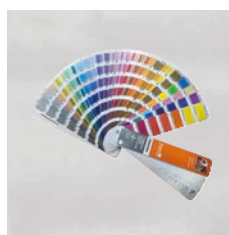
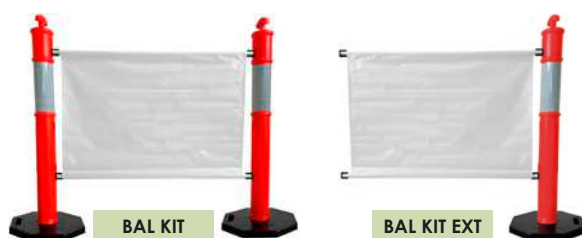

Toile PP enduit PVC  
 PVC coated polypropylene fabric  
 Lona de PP recubierta de PVC  
 PVC beschichtete Polyestergerewebe

Choix de couleur de fond, impression 4 couleurs  
 Background to customer choice, 4 colors print  
 Elección del color del fondo, impresión a 4 colores  
 Wahl der Hintergrundfarbe, 4-farbiger Druck

**BÂCHE BRISE VENT** ◦ **WIND BREAK TARPAULIN**  
**LONA CORTAVIENTOS** ◦ **WINDFESTE PLANE**

Minimum 5 barrières ◦ Minimum order 5 barriers  
 Pedido mínimo: 5 barreras  
 Mini Bestellungen 5 Absperrungen



Bâche brise vent microperforée  
 Microperforation wind break tarpaulin  
 Lona cortavientos microperforada  
 Mikroperforierte Windschutzhülle

Choix de couleur de fond, impression 4 couleurs  
 Background to customer choice, 4 colors print  
 Elección del color del fondo, impresión a 4 colores  
 Wahl der Hintergrundfarbe, 4-farbiger Druck



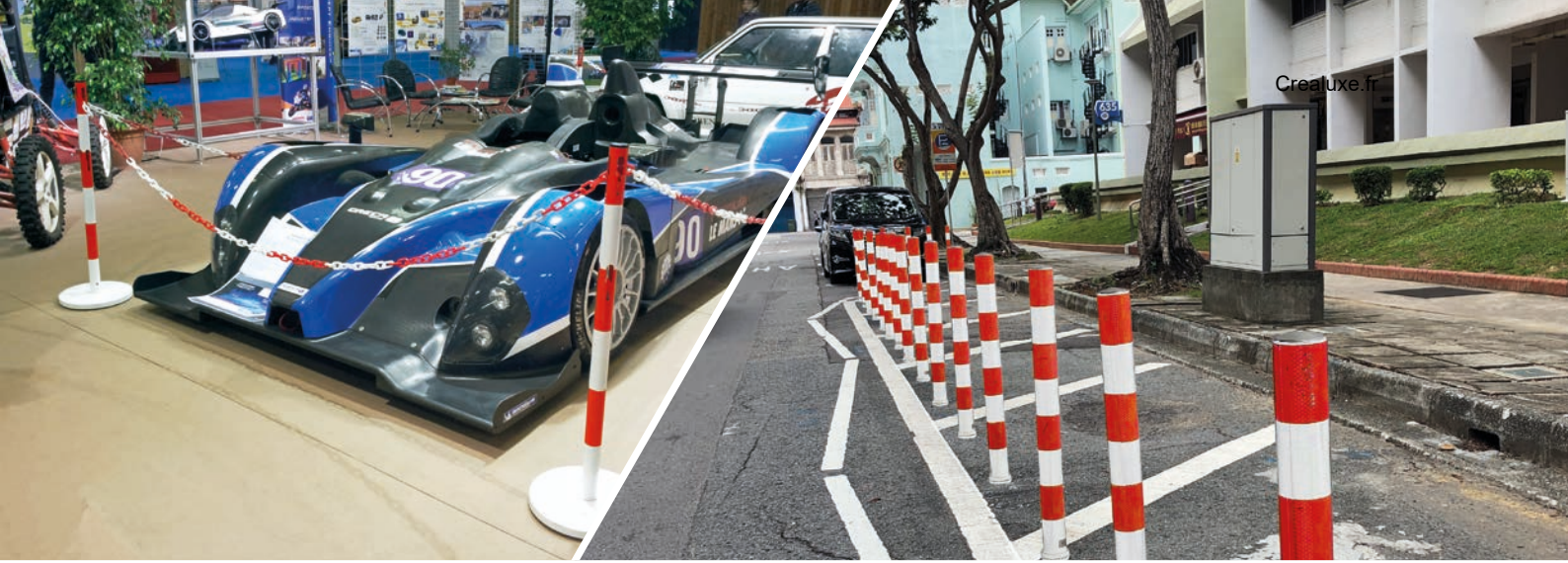

**ACIER** ◦ **STEEL** ◦ **ACERO** ◦ **STAHL**



**POTEAUX ET BASES** ◦ **POSTS AND BASES** ◦ **POSTES Y BASES** ◦ **PFOSTEN UND BASEN**

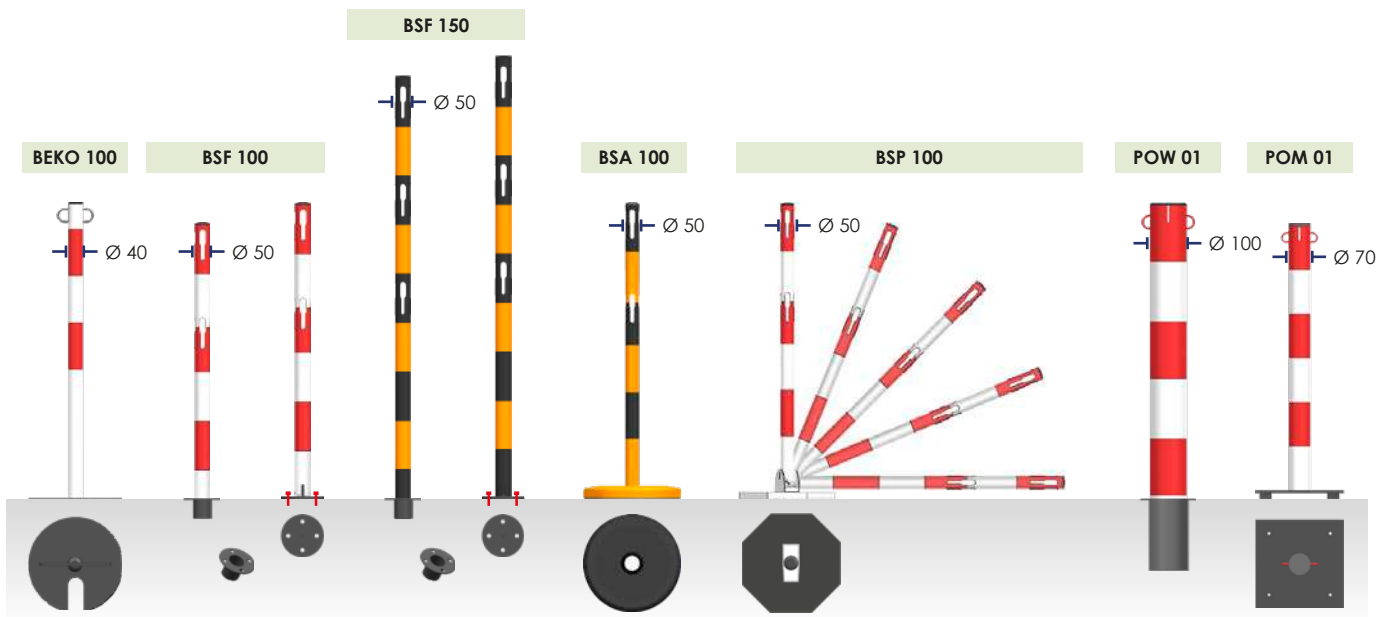

**KITS**

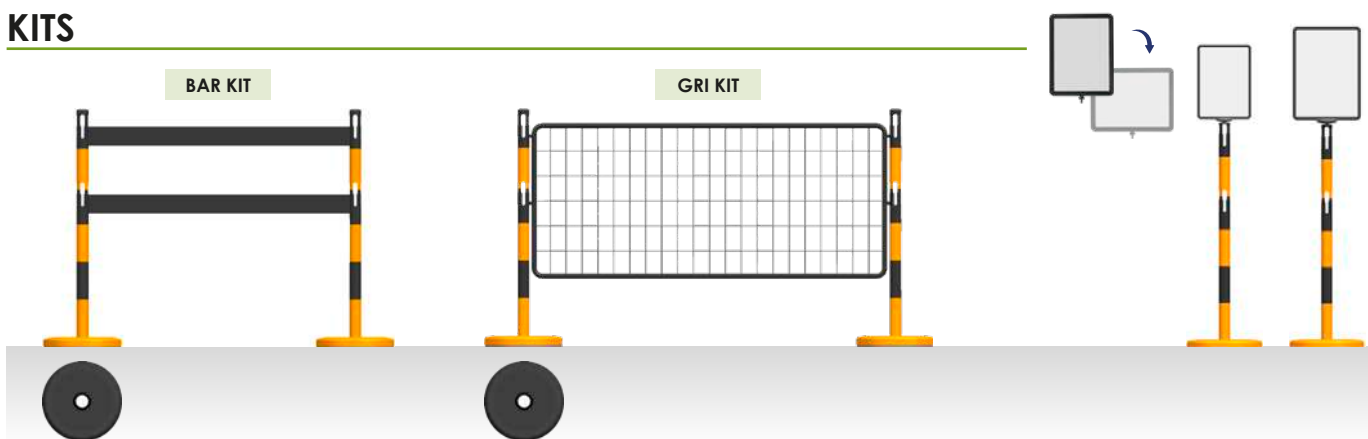

**ACCESSOIRES** ◦ **ACCESSORIES** ◦ **ACCESORIOS** ◦ **ZUBEHÖR**





**BSA**

**POTEAU ACIER BASE LESTÉE**  
**STEEL POST WITH LOADED BASE** ◦ **POSTE DE ACERO CON BASE PESADA**  
**KETTENSTÄNDER AUS STAHL MIT SCHWERE BASISPLATTE**

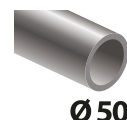

Code	
BSA 100 AISI *	
BSA 100 B	
BSA 100 N	
BSA 100 RB	
BSA 100 NJ	



2 niveaux  
2 levels  
2 niveles  
2 Aufhängenhöhen



4 directions  
4 directions  
4 direcciones  
4 Anschlusse

INCLUS ◦ INCLUDED ◦ INCLUIDO ◦ INKLUSIVE



OPTION ◦ OPTIONAL ◦ OPCIÓN ◦ OPTIONAL

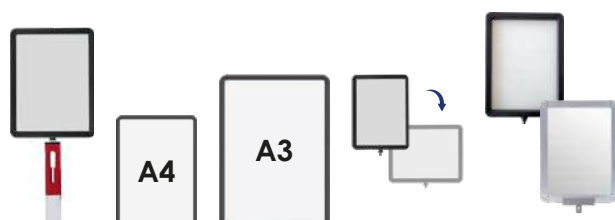

Code		
RS A4 PN		ABS
RS A3 PN		
RS A4		alu
RS A3		







**BSP 100**



**BSF**

**POTEAU DE BALISAGE**  
SIGN POST ◦ POSTE DE BALIZAMIENTO  
KETTENSTÄNDER



4 directions  
4 direcciones  
4 Richtungen

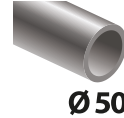

Ø 50



BSF 100 AISI

**À FIXER** ◦ TO FIX ◦ FIJOS ◦ ZU BEFESTIGENDEN

Code	
BSF 100 AISI *	
BSF 100 B	
BSF 100 N	
BSF 100 RB	
BSF 100 NJ	



BSF 100



BSF 150

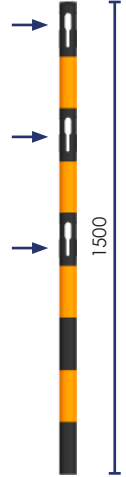
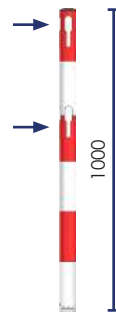

Code	
BSF 150 RB	
BSF 150 NJ	



**REPLIABLE** ◦ FOLDABLE ◦ PLEGABLE ◦ ZUSAMMENLEGBAR

Code	
BSP 100 B	
BSP 100 RB	
BSP 100 NJ	

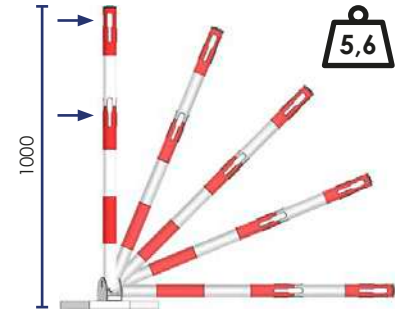
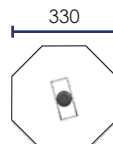

OPTION ◦ OPTIONAL ◦ OPCIÓN ◦ OPTIONAL ▶ BSF 100 / 150

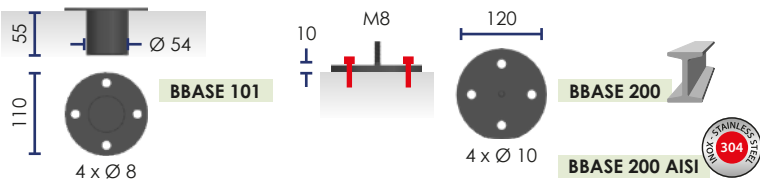

INCLUS ◦ INCLUDED ◦ INCLUIDO ◦ INKLUSIVE





POT 6 KIT



POT 1 KIT

# KIT CHAINE ACIER

## STEEL CHAIN KIT

### KIT CADENA METALICA ○ SET KETTEN STAHL



4 directions  
4 direcciones  
4 Richtungen

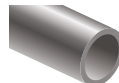

Ø50



POT - AISI -

Code	
POT 1 B KIT	○
POT 1 N KIT	●
POT 1 R KIT	◐
POT 1 J KIT	◑
POT 1 AISI KIT *	●

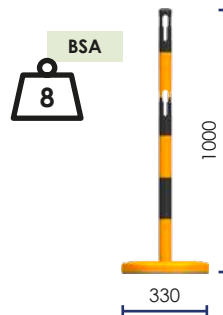

Code	
POT 6 B KIT	○
POT 6 N KIT	●
POT 6 R KIT	◐
POT 6 NJ KIT	◑
POT 6 AISI KIT *	●

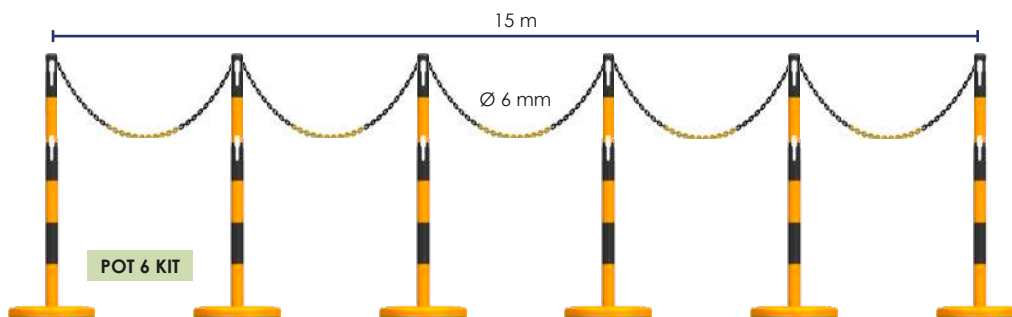

Code	
POT 1 B EXT	○
POT 1 N EXT	●
POT 1 R EXT	◐
POT 1 J EXT	◑
POT 1 AISI EXT *	●

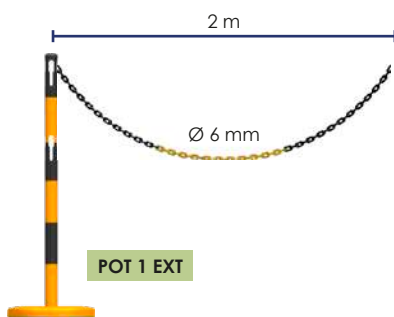

INCLUS ○ INCLUDED ○ INCLUIDO ○ INKLUSIVE



OPTION  
OPTIONAL  
OPCIÓN  
OPTIONAL

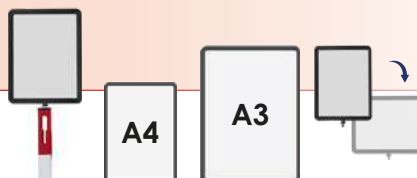

Code	
RS A4 PN	●
RS A3 PN	●
RS A4	○
RS A3	○



\* Poteaux et chaîne inox ○ Stainless steel posts and chain ○ Postes y cadena en acero inoxidable ○ Pfosten und Kette aus Edelstahl



# GRI KIT

## KIT GRILLE POSE LIBRE

FENCE KIT

KIT CON REJA ◦ SET ABSPERRUNG MIT GITTER

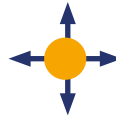

4 directions  
4 directions  
4 direcciones  
4 Richtungen

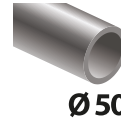

Code	
GRI CH KIT *	
GRI BK KIT	
GRI RB KIT	
GRI NJ KIT	

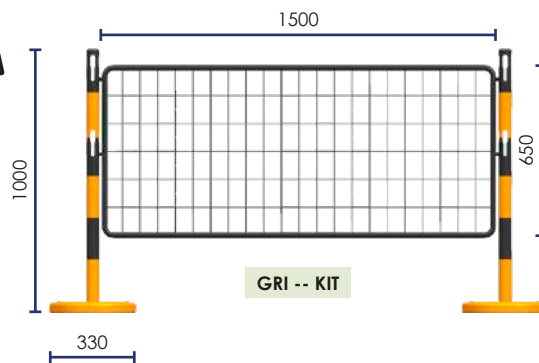

Code	
GRI CH EXT *	
GRI BK EXT	
GRI RB EXT	
GRI NJ EXT	

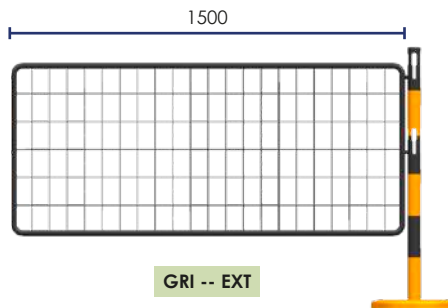

Code	
B 1500 ZG *	ZINGUÉ ZINC ZINCADO VERZINKTE
B 1500 N	
B 1500 R	

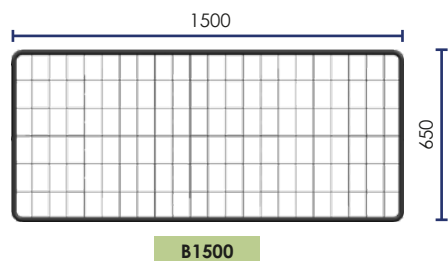

OPTION ◦ OPTIONAL ◦ OPCIÓN ◦ OPTIONAL

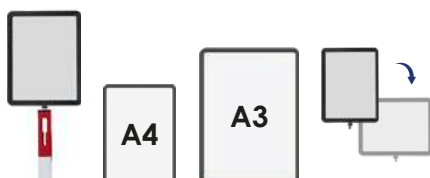

Code	
RS A4 PN	
RS A3 PN	
RS A4	
RS A3	

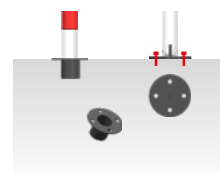

Fixation dans le sol ► p. 183  
Ground fixing ► p. 183  
Fijación al suelo ► p. 183  
Fixierung im Boden ► p. 183

\* Poteaux inox - Barrière acier zingué ◦ Stainless steel posts - zinc plated fence  
Postes de acero inoxidable - valla galvanizada ◦ Pfosten aus Edelstahl - Schranke aus verzinktem Stahl



# BAR- KIT

## KIT BARRIÈRE POSE LIBRE ◦ BARRIERS KIT KIT CON BARRERAS ◦ SET ABSPERRUNG MIT LATTEN



4 directions  
4 directions  
4 direcciones  
4 Richtungen

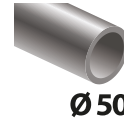

Code	
BAR-CH KIT *	
BAR-BK KIT	
BAR-RB KIT	
BAR-NJ KIT	

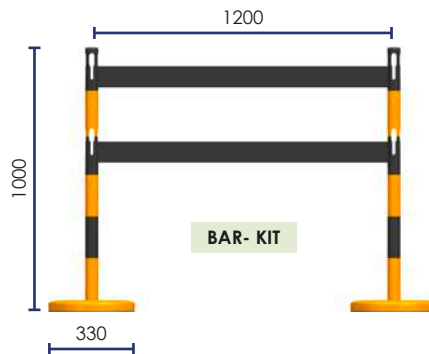

BAR- KIT



Code	
BAR-CH EXT *	
BAR-BK EXT	
BAR-RB EXT	
BAR-NJ EXT	

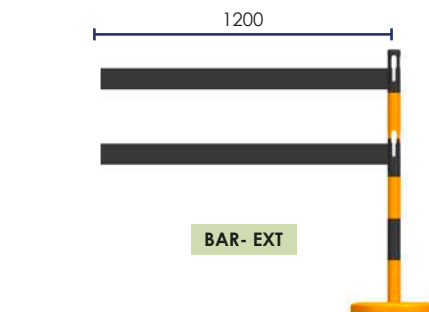

BAR- EXT



Code	
BSA 1202 ZG *	 ZINGUÉ ZINC ZINCADO VERZINKTE
BSA 1202 N	 alu
BSA 1202 RB	 5 PP

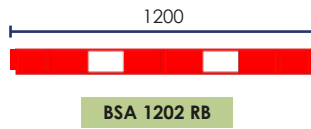
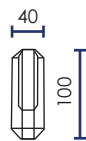

BSA 1202 RB



Code	
BSA 2101 RB	 5 PP

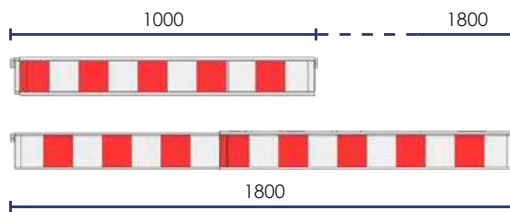
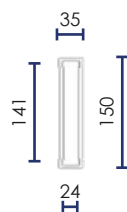

BSA 2101 RB



### OPTION ◦ OPTIONAL ◦ OPCIÓN ◦ OPTIONAL

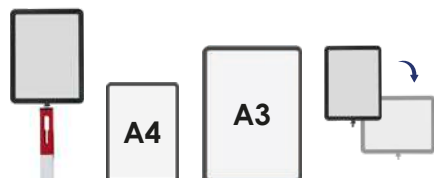

Code	
RS A4 PN	
RS A3 PN	
RS A4	 alu
RS A3	 alu

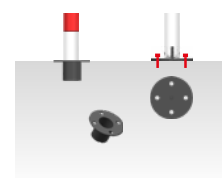

Fixation dans le sol ▶ p. 183  
Ground fixing ▶ p. 183  
Fijación al suelo ▶ p. 183  
Fixierung im Boden ▶ p. 183

\* Poteaux inox - Barrière acier zingué ◦ Stainless steel posts - zinc plated barriers  
Postes de acero inoxidable - barreras galvanizadas ◦ Pfosten aus Edelstahl - Schranke aus verzinktem Stahl



BEKO

**POTEAU EMPILABLE ACIER** ◦ **STACKABLE STEEL POST**  
**POSTE ACERO APILABLE** ◦ **KETTENSTÄNDER AUS STAHL**

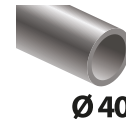

Code	
BEKO 100 BK	
BEKO 100 RB	
BEKO 100 NJ	

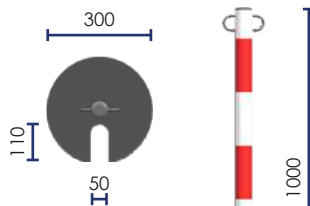

**INCLUS** ◦ **INCLUDED** ◦ **INCLUIDO** ◦ **INKLUSIVE**



Protection  
 Protection  
 Protección  
 Schutzplatte

**OPTION** ◦ **OPTIONAL** ◦ **OPCIÓN** ◦ **OPTIONAL**

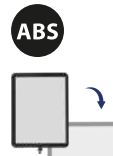
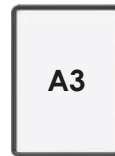
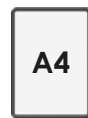

TUBEKO 100 RB + BBASE 40

BEKO 100

**POTEAUX D'INFORMATION** ◦ **INFORMATION POST**  
**POSTE DE INFORMACIÓN** ◦ **INFO STÄNDER**

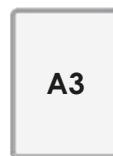
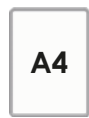

BSA 1004



BSA 1003



BKI 1004

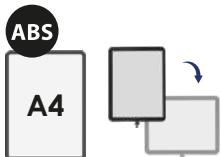

Code	
BKI 1004 RB	
BKI 1004 NJ	
BKI 1004 B	

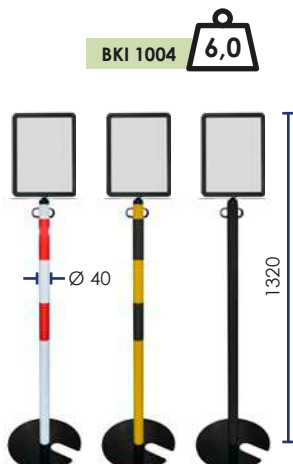

Code		
BSA 1004 RB		A4
BSA 1004 NJ		
BSA 1004 B		
BSA 1004 N		
BSA 1004 AISI		
BSA 1003 RB		A3
BSA 1003 NJ		
BSA 1003 B		
BSA 1003 N		
BSA 1003 AISI		





## CHAINE ACIER ET ACCESSOIRES ◦ STEEL CHAIN AND ACCESSORIES CADENA DE ACERO Y ACCESORIOS ◦ STAHLKETTEN UND ZUBEHÖR

DIN 236 NB

CDI 236 NB



DVD 350

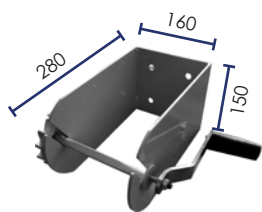

Avec blocage - Livré sans fixation  
With stop - No fixation included  
Con bloqueo - No incluye fijaciones  
Mit Blockierung - Ohne Fixierung



Ø 6

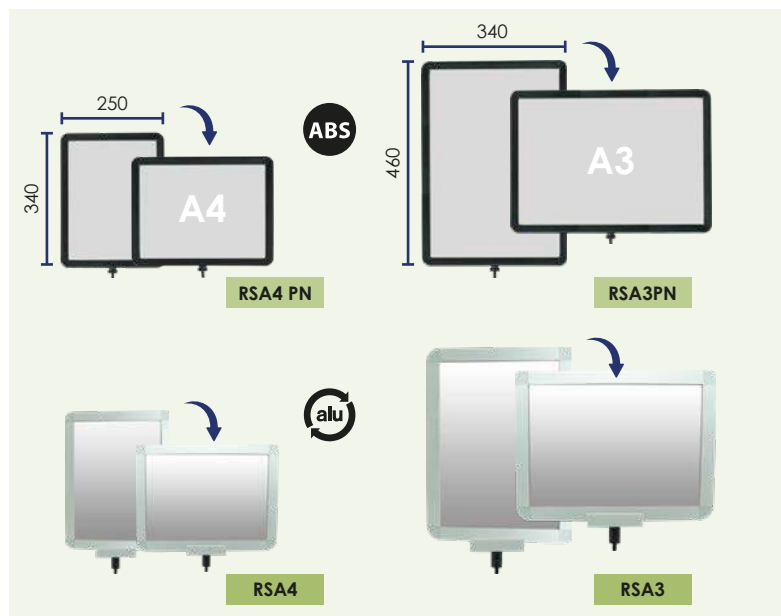

Ø 6



Ø 6

Code	*		↔	kg
DIN 236 NB	2	●		16,5
CDI 236 NB	1	●	25 m	17
NAU 64 NB	3	●		20
DIN 233 RB CT	4	●		9,3
DIN 233 NJ CT	4	●	15 m	9,3
DIN 233 BL CT	4	○		9,3
CDCH 25 SB	5	●		1,4
DIN 225 RB SB	4	●		1,7
DIN 225 NJ SB	4	●	2 m	1,7
DIN 225 B SB	4	○		1,7
DIN 225 N SB	4	●		1,7



Code	*		
MRA 602 NS	2	●	x 2
MRI 602 NS	1	●	x 2
MRAR 604 SB	4	●	x 4
MRAN 604 SB	4	●	x 4

Code	*		
ESS 582 NP	2	●	x 2
ESI 502 NS	1	●	x 2
ESR 584 SB	4	●	x 4
ESW 584 SB	4	○	x 4
ESN 584 SB	4	●	x 4
ESNJ 584 NS	4	●	2 ● + 2 ●

MDI 602 NS



MAN 602 NS



CPF 80 E



APV 80 E



- \* 1 ▷ Inox ◦ Stainless steel ◦ Acero inoxidable ◦ Nichtrostend
- 2 ▷ Zingué ◦ Zinc ◦ Zincado ◦ Verzinkte
- 3 ▷ Galva à chaud ◦ Galvanized steel ◦ Acero galvanizado ◦ Nichtrostend
- 4 ▷ Epoxy
- 5 ▷ Chromé ◦ Chromed ◦ Cromado ◦ Verchromte



POW 01 RB

POM 01 RB

**POTEAUX SÉRIE LOURDE** ○ **HEAVY DUTY POST**  
**POSTES ALTA RESISTENCIA** ○ **METALL PFOSTEN – « BIG » AUSFÜHRUNG**



PEINTURE ÉPOXY  
 POWDER PAINTING  
 PINTURA EPOXICA  
 EPOXY FARBE

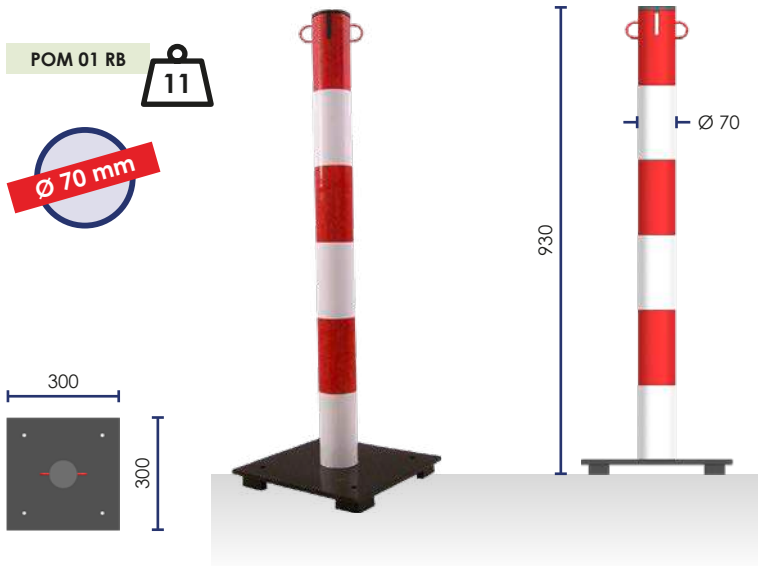

DIN 233 RB CT



DIN 225 RB SB

Ø 6

Code	*			
DIN 233 RB CT	4		15 m	9,3
DIN 225 RB SB	4		2 m	1,7

\* 4 ▷ Epoxy

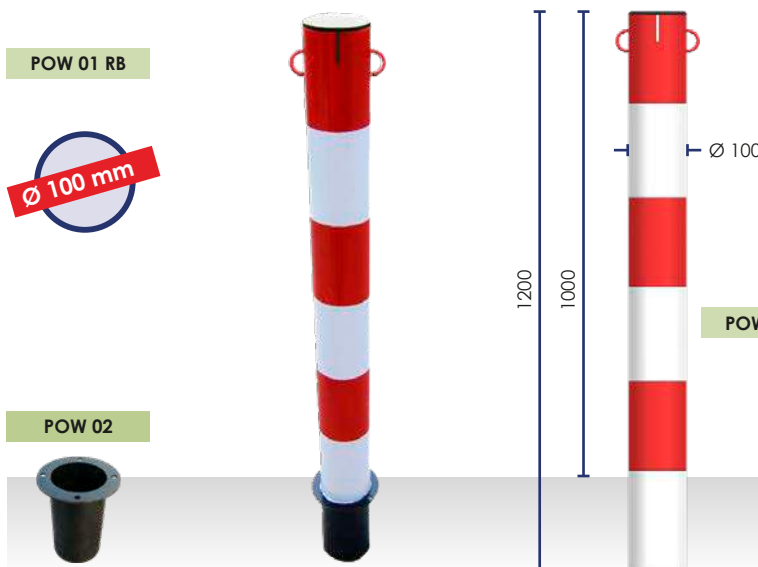

POW 01 RB



POW 02



POW 01 RB

POW 02

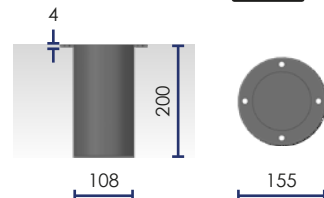







**FLEXTYPE**

**EXTENSOTYPE**

**BARRIÈRE EXTENSIBLE** ○ **EXPANDABLE BARRIER**  
**BARRERA EXTENSIBLE** ○ **ABSPERR-SCHERENGITTER**



**FLEXTYPE** 2,00 m

Code		kg
FLEXTYPE 200 RB		4,80
FLEXTYPE EXTRB		3,40
FLEXTYPE 200 NJ		4,80
FLEXTYPE EXTNJ		3,40

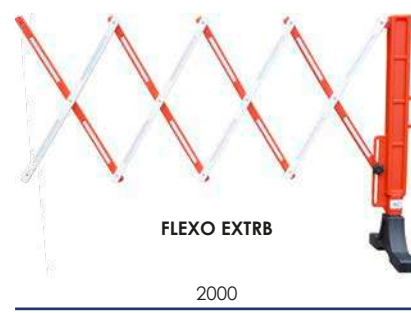
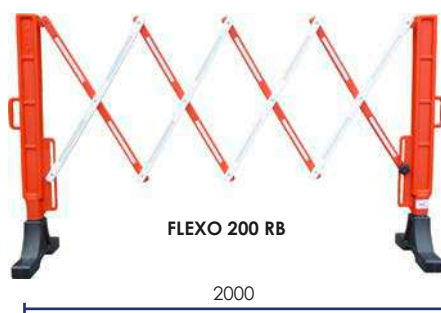
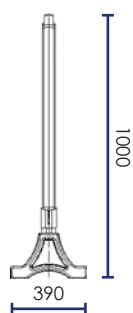

**EXTENSOTYPE** 2,40 m

Code		kg
EXTENSOTYPE		7,50
EXTENSOTYPE JA		7,50

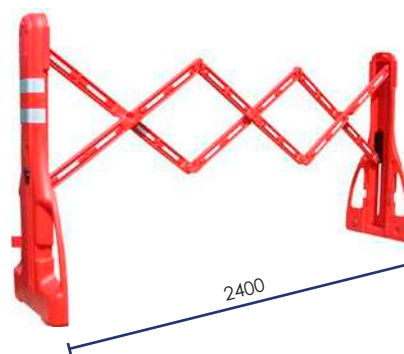
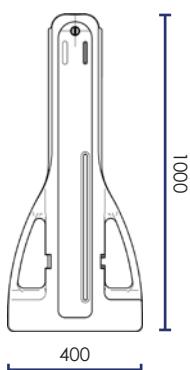
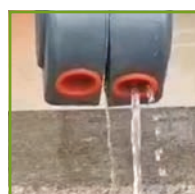

OPTION ○ OPTIONAL ○ OPCIÓN ○ OPCIÓNAL





# BAR 3000

## BARRIÈRE EXTENSIBLE ◦ EXPANDABLE BARRIER BARRERA EXTENSIBLE ◦ SCHERRENSPERREN

3,00 m



Code	
BAR 3000 RB	
BAR 3000 BK	
BAR 3 EXT RB	
BAR 3 EXT BK	

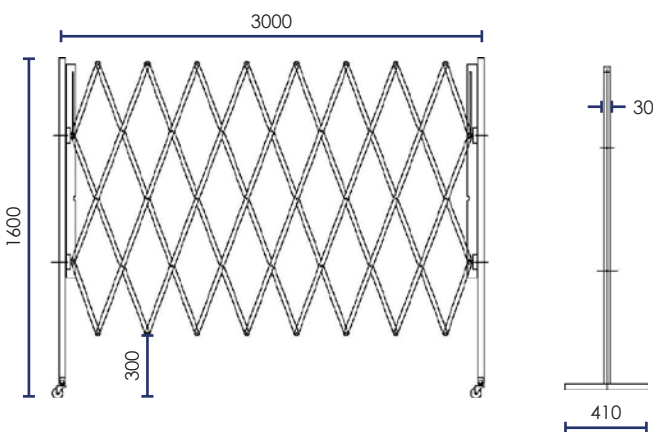
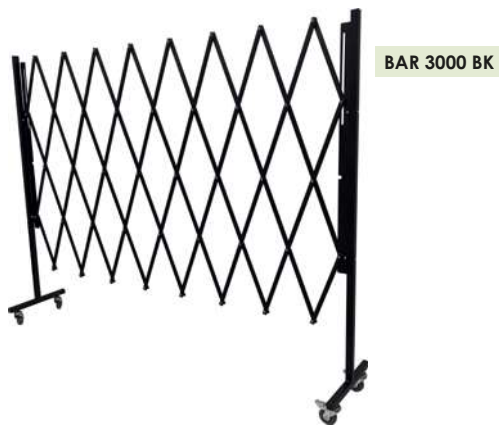

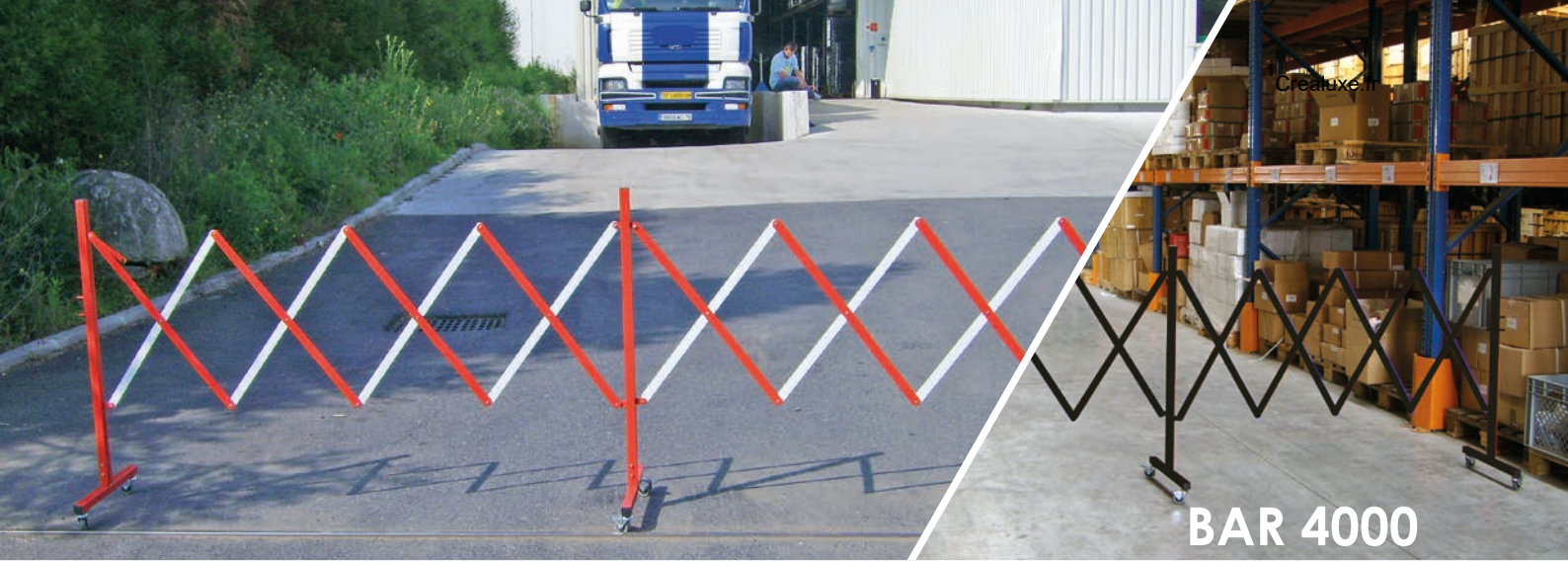

BAR 4000

**BARRIÈRE EXTENSIBLE** ◦ **EXPANDABLE BARRIER**  
**BARRERA EXTENSIBLE** ◦ **SCHERRENSPERREN**

4,00 m



Code	
BAR 4000	
BAR 4000 NJ	
BAR 4000 BK	

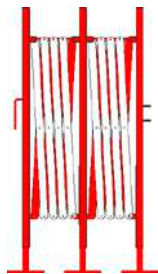

BAR 4000

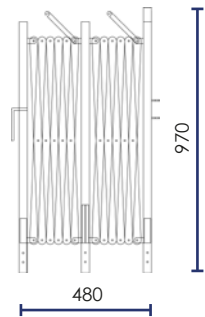
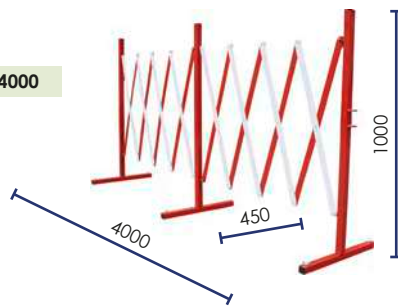

Code	
BAR 4000 FIX	
BAR 4000 NJ FIX	
BAR 4000 BK FIX	

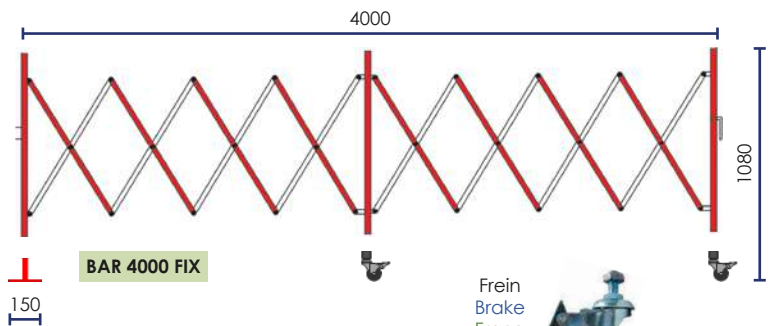

BAR 4000 FIX

Frein  
 Brake  
 Freno  
 Bremse

WH 501 SB  
 Ø 50 mm

Code	
BAR 4006 RB	
BAR 4006 NJ	
BAR 4006 BK	



BAR 4006 RB

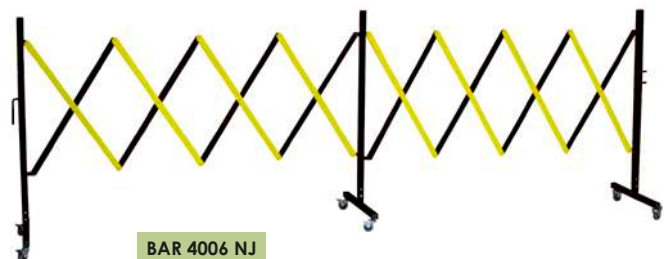

BAR 4006 NJ

OPTION ◦ OPTIONAL ◦ OPCIÓN ◦ OPTIONAL

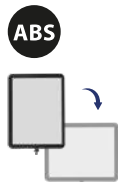
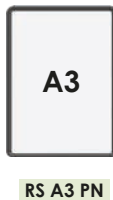
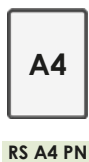
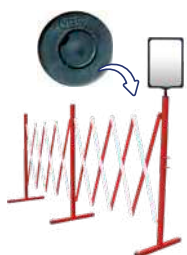

Kit de fixation murale ◦ Wall fixing kit  
 Kit de fijación a la pared  
 Wandbefestigungsset

# coffee

COMPTOIR DES ARÔMES

SUCRE ET  
TOUILLETTE  
DISPONIBLES  
EN CAISSE

PORT DU MASQUE  
OBLIGATOIRE  
Même de votre côté



NOTRE CARTE  
TOUTES LES  
MIGNARDISES  
À  
PRIX  
MINI

NOTRE CARTE  
TOUTES LES  
MIGNARDISES  
À  
PRIX  
MINI

NOTRE CARTE  
TOUTES LES  
MIGNARDISES

SIMPLE ET PRATIQUE  
COMME LE PAIEMENT  
SANS CONTACT !  
FAITES DES  
ÉCONOMIES !





**PARAVENT / BARRIÈRE DE PROTECTION**

- Auto portante
- 2 hauteurs : 1 m ou 1,80 m
- En 3 vantaux
- Inox ou PVC
- Repliable
- Tissus à assembler sur l'armature par le client
- Tissu imprimé 1 face.
- Panneaux décoratifs avec velcro :
  - ▷ Facile à mettre en place
  - ▷ Facile à tendre
  - ▷ Tissus lavables
- Option
  - ▶ Tissu Ignifugé, impression 3 couleurs
  - ▶ Tissu brise vent, impression 3 couleurs
  - ▶ Autre couleur de Tissu (Mini. 15 barrières)
  - ▶ Personnalisation quadri (tissu standard)
  - ▶ Sac de transport

**SCREEN / PROTECTION BARRIER**

- Self Standing
- 2 heights: 1 m or 1.80 m
- In 3 panels
- Stainless steel or PVC
- Foldable
- Fabrics to be mounted on the frame by the customer
- 1 side printed fabric
- Decorative panels with velcro :
  - ▷ Easy to put in place
  - ▷ Easy to stretch
  - ▷ Washable fabrics
- Optional
  - ▶ Flame retardant fabric, 3 colors printing
  - ▶ Windproof fabric, 3 colors printing
  - ▶ Other color of Fabric (Mini 15)
  - ▶ Customization 4 colors (standard fabric)
  - ▶ Transport bag

**BIOMBO / BARRERA DE SEÑALIZACIÓN**

- Estructura autoportante
- 2 alturas: 1 m o 1,80 m
- De 3 paneles
- Acero inoxidable o PVC
- Plegable
- Armados de los tejidos en el marco por el cliente
- Tejido impreso a 1 cara
- Paneles decorativos con velcro:
  - ▷ Fácil de colocar
  - ▷ Fácil de tender
  - ▷ Tejidos lavables
- Opción
  - ▶ Tejido ignífugo impresión a 3 colores
  - ▶ Tejido cortaviento impresión a 3 colores
  - ▶ Otro color de tejido (Mini 15)
  - ▶ Impresión a 4 colores (tejido estándar)
  - ▶ Bolsa de transporte

**SCHUTZ BARRIERE / SICHTSCHUTZ**

- Freistehend
- Höhe : 1 m oder 1,8m
- 3 Sicht- / Schutzfelder
- Ständer Ausführung in Stahl oder Kunststoff
- Faltbar
- Montage der Elemente vor Ort durch Kunden
- 1 Seite ist bedruckt.
- Bespannung mit Klettverschluss :
  - ▷ einfach zu montieren
  - ▷ ist dehnbar
  - ▷ waschbar
- Optional
  - ▶ Flammfestes Gewebe 3 Farben-Druck
  - ▶ Windiges Gewebe 3 Farben-Druck
  - ▶ Andere Farbversion (Mind. 15 Stück)
  - ▶ 4 Farben-druck (standard gewebe)
  - ▶ Transporttasche



**ENR 200**

**BARRIÈRE AVEC ENROULEUR** ◦ **EXPANDABLE / RETRACTABLE BARRIER**  
**BARRERA DE SEÑALIZACIÓN CON ENROLLADOR** ◦ **EINZIEHBARE ABSPERROLLE**

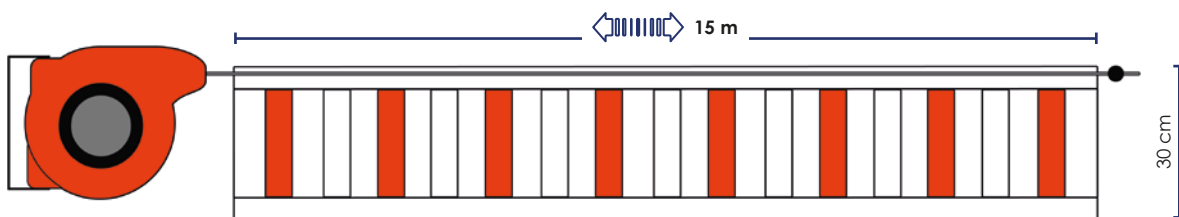

390 x 120 x 270 4.0



**ENR 200 OR**  
 Réflechissant  
 Reflective  
 Reflektivo  
 Reflektierend

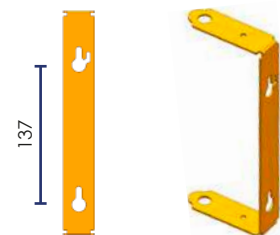

**ENR 200 RB**



**ENR 200 NJ**

**INCLUS** ◦ **INCLUDED**  
**INCLUIDO** ◦ **INKLUSIVE**



**OPTION** ◦ **OPTIONAL** ◦ **OPCIÓN** ◦ **OPTIONAL**

**ENR 200 ROUTE**  
 87 x 28 cm

**ROUTE BARREE**

**ENR 200 ACCES**  
 87 x 28 cm

**ACCES INTERDIT**

**ENR 200 SI**  
 29 x 27 cm





ENR 200

**OPTIONS** ○ **OPTIONS** ○ **OPCIONES** ○ **OPTIONEN**

**ENR BOX**

500 x 200 x H 480



Porte coulissante  
Sliding door  
Puerta corrediza  
Schiebetürsystem



**ENR POST 140**



Poteau support et récepteur  
Fixing post and receiver  
Poste soporte y receptor  
Doppelte Funktion:Träger und Empfänger

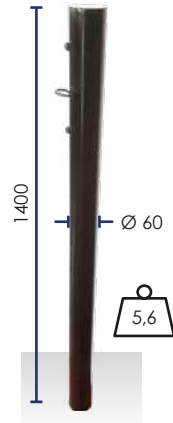

**BASE 2500**

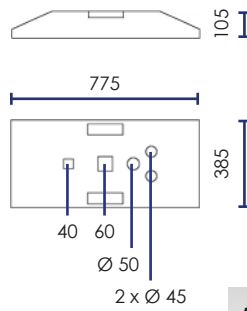

ENR 200 + BBASE

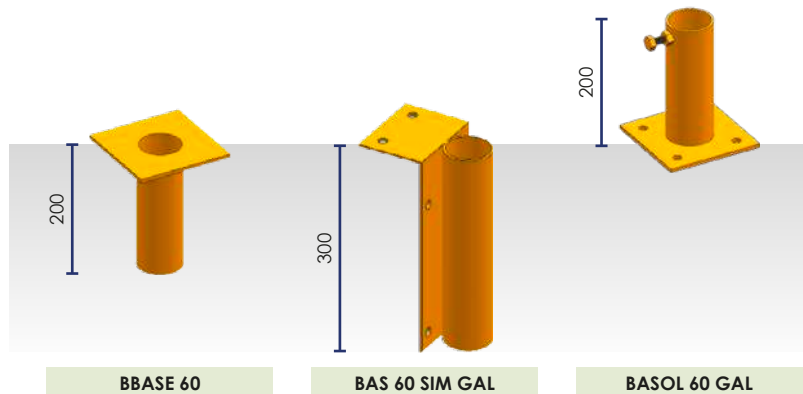

BBASE 60

BAS 60 SIM GAL

BASOL 60 GAL



RSNA

CHAINE

## RUBAN DE SIGNALISATION

WARNING TAPE ◦ CINTA DE SEÑALIZACIÓN ◦ ABSPERRBÄNDER



### IMPRESSION 1 FACE ◦ 1 SIDE PRINTING ◦ IMPRESIÓN 1 CARA ◦ 1-SEITIG BEDRUCKEN

Code	
RSNA 01 RB	x 36
RSNA 121 RB	x 12
RSNA 01 NJ	x 36
RSNA 121 NJ	x 12
RSNA 01 VE	x 36
RSNA 121 VE	x 12

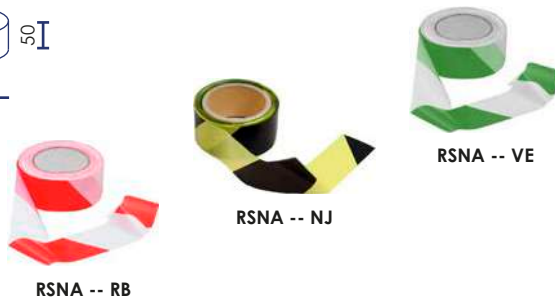
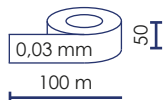

### IMPRESSION 2 FACES ◦ 2 SIDES PRINTING ◦ IMPRESIÓN 2 CARAS ◦ 2-SEITIG BEDRUCKEN

Code	
RSNA 02 RB	x 36

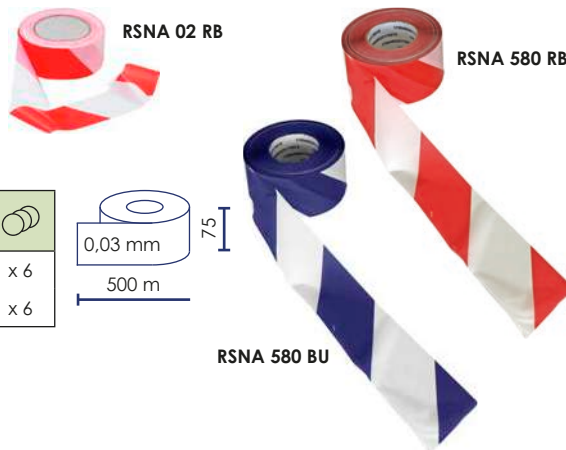
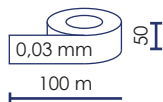

Code	
RSNA 580 RB	x 6
RSNA 580 BU	x 6

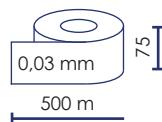

#### ACCESSOIRES ◦ ACCESSORIES ACCESORIOS ◦ ZUBEHÖR

##### PFER 520 SB



##### SP 1205 SB

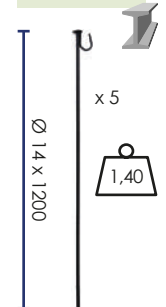

## CHAINE POLYPRO

POLYPROPYLENE CHAIN ◦ CADENA DE PLÁSTICO ◦ KUNSTSTOFFKETTEN



Code	
CFLUO 825 SBS	○
CNJ 801 SBS	●
CBR 801 SBS	●
CPB 801 SBS	○
CPR 801 SBS*	●
CBV 801 SBS	●
CBB 801 SBS	●
CPN 801 SBS	●

25 m - Ø 8



CFLUO 825 SBS



Accessoires ▶ p. 175  
Accessories ▶ p. 175  
Accesorios ▶ p. 175  
Zubehör ▶ p. 175

\* Epuisement stock ◦ While stock lasts ◦ Hasta agotar existencias ◦ Lagervorrat Begrenzung





GUI 200

GUI 500

**BANDEAU DE SIGNALISATION TISSU** ○ HIGH VISIBILITY WARNING STRIP  
**BANDA DE ADVERTENCIA ALTA VISIBILIDAD** ○ **BAND MIT HOHER SICHTBARKEIT**



5 M



Bandes lestées  
 Weighted bottom  
 Bandas lastradas  
 unten des Bands gewichtet

GUI 500 OR

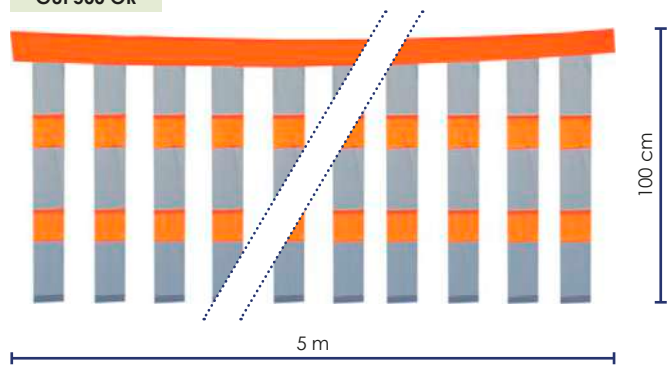

20 M



Bandes réfléchissantes  
 Reflective tapes  
 Tiras reflectantes  
 Reflektierende Streifen



GUI 200 OR

CLASSE 1

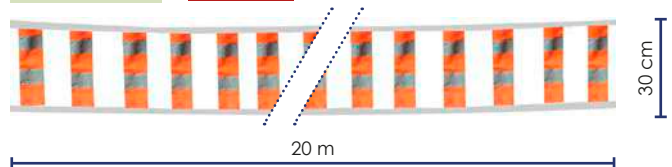

GUI 200 RB

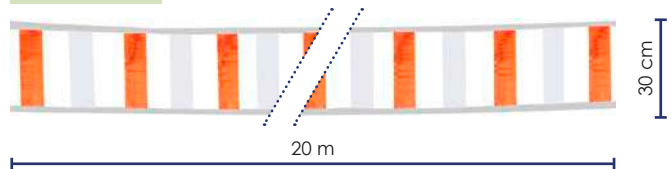

INCLUS ○ INCLUDED ○ INCLUIDO ○ INKLUSIVE



Sac de rangement  
 Storage bag  
 Bolsa de almacenamiento  
 Aufbewahrungstasche

OPTION ○ OPTIONAL ○ OPCIÓN ○ OPTIONAL

ENR 200 ROUTE  
 87 x 28 cm

ROUTE BARREE

ENR 200 ACCES  
 87 x 28 cm

ACCES INTERDIT

ENR 200 SI  
 29 x 27 cm





RSNT 100

RSA

**RUBAN DE BALISAGE** ◦ MARKING TAPE ◦ CINTA DE SEÑALIZACIÓN ◦ BODENMARKIERUNG

**ADHÉSIF** ◦ ADHESIVE ◦ ADHESIVO ◦ KLEBSTOFF

Code		
RSA 335 STOP NJ		x 6
RSA 335 NJ		x 6
RSA 335 RB		x 6

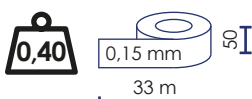

RSA 335 STOP NJ



RSA 335 NJ



RSA 335 RB



**ANTI-DÉRAPANT** ◦ NON SKID ◦ ANTIDESLIZANTE ◦ ANTIRUTSCH VERSION

Code		
RSA 550 BK		x 6
RSA 550 NJ		x 6
RSA 550 RB		x 6
RSA 550 BYB		x 6

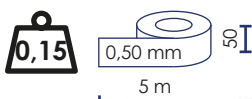

RSA 550 BYB

Code		
RSA 5100 BK		x 1
RSA 5100 NJ		x 1

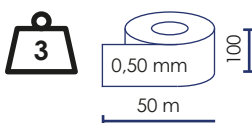

RSA 5100 BK



**RÉFLÉCHISSANT ET ANTI-DÉRAPANT \*** ◦ NON SKID AND REFLECTIVE  
REFLECTIVO Y ANTIDESLIZANTE ◦ REFLEKTIEREND & ANTIRUTSCH VERSION

Code		
RSNT 100 JA		x 1
RSNT 100 BL		x 1
PODGLUE2 *		



\* A poser avec colle ◦ To fix with glue ◦ Usar pegamento ◦ Befestigung durch Kleber



Colle époxydique souple 2 composants pour béton  
Flexible 2-component epoxy adhesive for concrete  
Adhesivo epoxídico flexible de 2 componentes para hormigón  
2-Komponenten Kleber für Beton





PDM

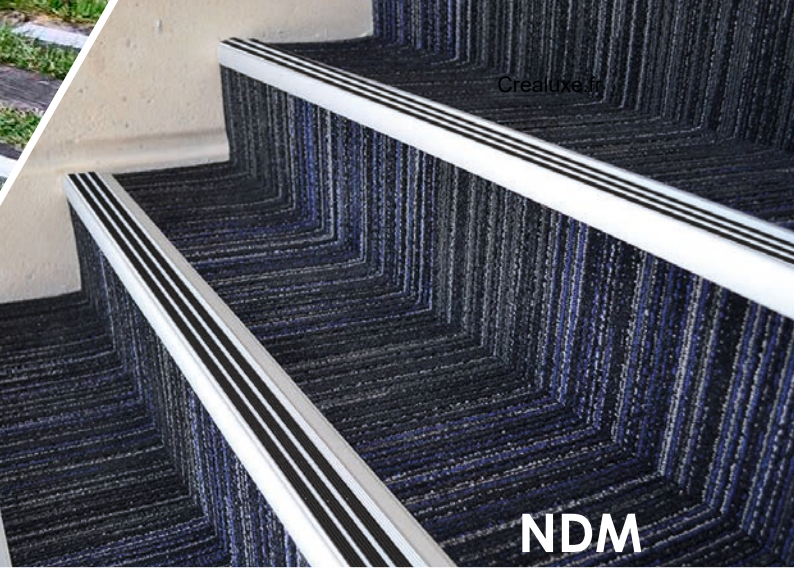

NDM

**NEZ DE MARCHE ANTIDÉRAPANT** ○ **NON-SLIP STAIR NOSING**  
**PERFIL ANTIDESLIZANTE PARA PELDAÑOS** ○ **RUSTCHFEST TREPPENKANTENPROFIL**



Code			
NDM 900 PVC	●	3 x 5 mm	0,80
NDM 900 BK	●		0,80
NDM 900 FLUO	●		0,80
NDM 1300 PVC	●	4 x 5 mm	1,20
NDM 1300 BK	●		1,20
NDM 1300 FLUO	●		1,20

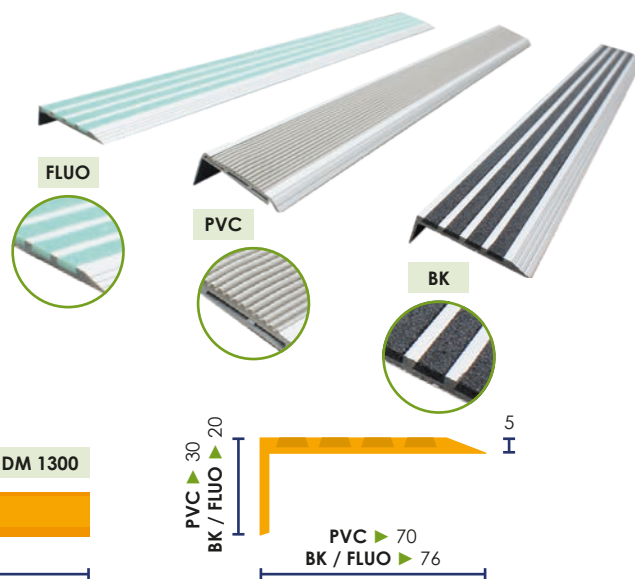

non fourni ○ not supplied ○ no incluido ○ nicht enthalten

NDM 900



900



NDM 1300



1300



**PLAT DE MARCHE** ○ **STAIRS PAD**  
**PERFIL ANTIDESLIZANTE PARA PELDAÑOS** ○ **TREPPENKANTEN**



Code			
PDM 900 PVC	●	3 x 5 mm	0,80
PDM 900 BK	●		0,80
PDM 1300 PVC	●	4 x 5 mm	1,10
PDM 1300 BK	●		1,10

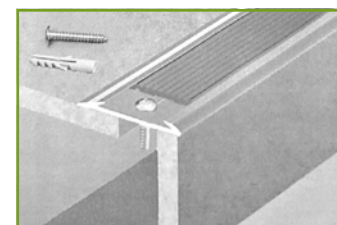
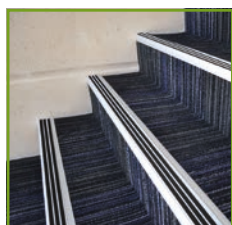

non fourni ○ not supplied ○ no incluido ○ nicht enthalten

PDM 900



900



PDM 1300



1300

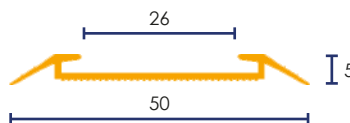

OPTION  
 OPCIÓN  
 OPZIONALE



RQ GLUE



SOLEX

**ADHÉSIF POUR MARQUAGE AU SOL EXTÉRIEUR**  
**OUTDOOR WARNING FLOOR STICKER**  
**ADHESIVO DE MARCADO PARA USO EXTERIOR**  
**BODENMARKIERUNGEN EXTERNE ANWENDUNG**

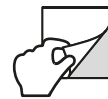

**ANTI-DÉRAPANT**

NON SKID ◦ ANTIDESLIZANTE ◦ ANTIRUTSCH VERSION



Impression sur vinyle adhésif antidérapant spécialement conçu pour asphalte, trottoirs ou béton.

Printing on non-slip adhesive vinyl specially designed for asphalt, sidewalks or concrete.

Impresión sobre vinilo adhesivo antideslizante especialmente diseñado para asfalto, aceras u hormigón.

Druck auf rutschfestem Klebevinyl speziell für Asphalt, Gehwege oder Beton.



**SOLEX 305 FLEC**

30 x 5 cm

x 5

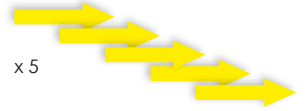

**SOLEX 280 PAS**

28 x 10 cm

x 10 (5 + 5)



**SOLEX 845 PERS**

80 x 45 cm

x 2



**SOLEX 560 HAND**

600 x 500



**SOLEX 500 STAT**

Ø 500



**SOLEX 500 OBLI**

Ø 500



**SOLEX 500 PIET**

Ø 500



**SOLEX 500 SENS**

Ø 500



**SOLEX 100 ZEBRA**

100 x 25 cm

x 3

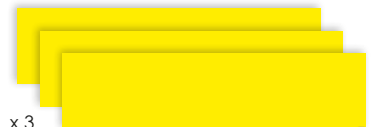

**SOLEX 453 CHUT**

45 x 35 cm



**SOLEX 453 TOMB**

45 x 35 cm





# ADHÉSIF POUR MARQUAGE AU SOL INTÉRIEUR

INDOOR WARNING FLOOR STICKER

ADHESIVO DE MARCADO PARA USO INTERIOR

WARN- & VERBOTSSCHILDER BODEN INNENBEREICH



## STANDARD

SOL 350 RSTOP

Ø 350



SOL 500 RCHAR

Ø 500



SOL 500 RFUM

Ø 500



SOL 500 RINT

Ø 500



SOL 500 ROBLI

Ø 500



SOL 500 RPIET

Ø 500



SOL 500 RSENS

Ø 500



## ANTI-DÉRAPANT

NON SKID

ANTIDESLIZANTE

ANTIRUTSCH VERSION



SAN 500 TCHAR

500 x 500 x 500



SAN 500 TELEC

500 x 500 x 500



SAN 500 TGLIS

500 x 500 x 500



SAN 500 CEXT

500 x 500





WALL 1200



WARN 1200

**RAMPE DE PORTAIL**

**GATE RAMP** ◦ **RAMPA DE ENTRADA** ◦ **EINFAHRTSCHWELLE VOR EINEM TOR**

CAOUTCHOUC  
RUBBER  
CAUCHO  
KAUSCHUK

WARN 1200

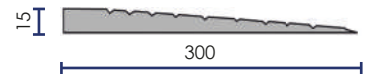
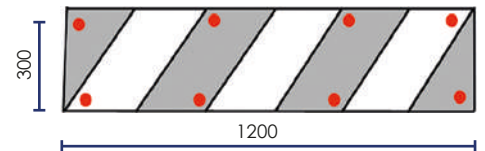

OPTION ◦ OPTIONAL ◦ OPCIÓN ◦ OPTIONAL



FSAFE  
x 8



RQ GLUE

**SIGNALISATION DE VIRAGE / PARKING**

**PARKING RAMP SIGN** ◦ **SEÑAL PARA APARCAMIENTO** ◦ **SIGNALISIERUNG**

CAOUTCHOUC  
RUBBER  
CAUCHO  
KAUSCHUK

WALL 1200



x 15  
Réflecteurs  
Eye cats  
Reflectores  
Reflektoren

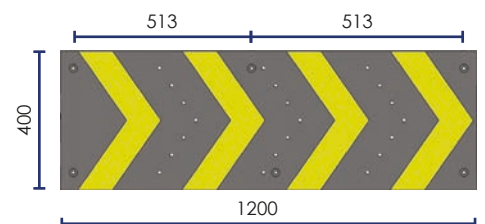

INCLUS ◦ INCLUDED ◦ INCLUIDO ◦ INKLUSIVE



x 6



x 15



# Créaluxe.fr

Crealuxe SARL  
BP 4003584101 Orange CEDEX  
04 86 71 54 42  
serviceclient@crealuxe.fr

